



MANTIS
User Manual



deep down you want the best

scubapro.com

MANTIS DIVING COMPUTER - DESIGNED BY DIVING ENGINEERS

Welcome to SCUBAPRO dive computers and thank you for purchasing MANTIS. You are now the owner of an extraordinary partner for your dives. This manual provides you easy access to SCUBAPRO state of the art technology and MANTIS key features and functions. Should you wish to know more about SCUBAPRO diving equipment, please visit our website www.scubapro.com.



WARNING

- MANTIS has a depth rating of 120m/394ft.
- If 120m is exceeded, -- will be shown in the depth field and decompression algorithm does not calculate correctly.
- Diving at oxygen partial pressures higher than 1.6bar (corresponding to a depth of 67m/220ft when breathing compressed air) is extremely dangerous and could lead to serious injury or death.
- MANTIS is delivered at deep sleep mode where the display is off. You must activate the MANTIS by press and hold the SEL button before the first dive. MANTIS does not start the dive mode or may show a wrong depth value if activation is not done before the immersion.



Mantis dive instrument is compliant with the European Union directive 2014/30/EU.

Standard EN 13319: 2000

Mantis dive instrument is also compliant with the European standard EN 13319: 2000 (EN 13319: 2000 – Depth gauges and combined depth and time measuring devices – Functional and safety requirements, tests methods).

TABLE OF CONTENTS

1. INTRODUCTION TO MANTIS	5
1.1 Battery	5
2. OPERATION MODES	6
3. MANTIS AS A WATCH	7
3.1 Clock setting functions	8
3.1.1 Setting the alarm clock	9
3.1.2 Setting the UTC	9
3.1.3 Setting the time	9
3.1.4 Setting 24h or am/pm mode	10
3.1.5 Setting the date	10
3.1.6 Setting the sound off (silent mode)	10
3.1.7 Accept code protection	10
3.1.8 Checking the battery status	11
3.2 Menus and functions at the surface	12
3.2.1 Using the stopwatch	13
3.2.2 Reading the altitude, barometer and temperature values	14
3.2.3 Planning a dive	15
3.2.4 Reading the logbook	17
3.2.4.1 Scuba log	18
3.2.4.2 Apnea log	19
3.2.4.3 Surface exercise logs	19
4. MANTIS AS A DIVE COMPUTER	20
4.1 Settings in the dive mode at surface	20
4.1.1 Surface interval counter	22
4.2 Gas settings	22
4.2.1 Set Gas 1, 2 or d	24
4.2.2 Enabling the CCR mode	25
4.2.3 Nitrox reset time	25
4.2.4 Heart rate limits	25
4.2.5 Desaturation reset	26
4.3 SCUBA settings	26
4.3.1 Maximum dive depth alarm	27
4.3.2 Maximum dive time alarm	27
4.3.3 Setting the Micro Bubble level	27
4.3.4 Units	27
4.3.5 Selecting the salt (sea) or fresh water	28
4.4 Apnea settings	28
4.4.1 Setting the apnea session total depth	28
4.4.2 Setting the surface interval factor	29
4.4.3 Setting the dual depth alarm	29
4.4.4 Setting the depth incremental alarm	30
4.4.5 Setting the dive time interval alarm	30
4.4.6 Setting the surface interval alarm	30
4.4.7 Setting the heart rate low limit	31
4.4.8 Setting the ascent speed alarm	31
4.5 SWIM mode	31
4.6 Algorithm selection	32
4.7 Diving with MANTIS	33
4.7.1 Display information	33
4.7.1.1 Display configuration during the dive	34
4.7.1.2 Skin temperature	34
4.7.1.3 Stop timer	34

	4.7.1.4	Setting bookmarks	35
	4.7.1.5	Safety stop timer	35
	4.7.1.6	Activating the backlight.....	35
	4.7.1.7	Diving with mb levels	35
	4.7.1.8	PDI stops	36
	4.7.2	No-dive warning after a dive	36
	4.7.3	SOS	37
	4.7.3.1	Desaturation reset.....	37
	4.7.4	Diving with nitrox	37
4.8		Diving with two or more gas mixtures	38
	4.8.1	Switching gas mixture during the dive	39
	4.8.2	Switching back to a gas mixture with lower oxygen concentration	40
	4.8.3	Gas switch not carried out at the planned depth	40
	4.8.4	Delayed gas switch	40
	4.8.5	Submerging below the mod after a gas switch	40
	4.8.6	Diving with CCR mode	40
	4.8.7	Enabling the CCR mode	41
	4.8.8	Altitude diving	41
	4.8.8.1	Altitude and the decompression algorithm	42
	4.8.8.2	Prohibited altitude.....	43
	4.8.8.3	Decompression dives in mountain lakes.....	43
	4.8.9	Warnings and alarms	43
	4.8.9.1	CNS O ₂ = 75%	44
	4.8.9.2	No-Stop time = 2 minutes.....	44
	4.8.9.3	Entering decompression	44
	4.8.9.4	MB LEVEL ignored	44
	4.8.9.5	Ascent rate	45
	4.8.9.6	MOD/ppO ₂	45
	4.8.9.7	CNS O ₂ = 100%	46
	4.8.9.8	Missed decompression stop	46
	4.8.9.9	High workload	46
	4.8.9.10	MB LEVEL reduced	47
	4.8.9.11	Low battery	47
	4.9	GAUGE mode	47
	4.10	APNEA mode	48
	4.11	SWIM mode	49
5.		MANTIS ASSESORIES	50
	5.1	HR belt	50
	5.2	Nylon arm strap	50
	5.3	Battery compartment o-ring	50
	5.4	Display guard	51
6.		MANTIS PC INTERFACE	51
	6.1	Cradle - accessory	51
	6.2	Introduction to Scubapro LogTRAK	51
	6.3	Change warnings/settings of the mantis and reading the computer information	52
7.		Taking care of mantis	52
	7.1	Technical information	52
	7.2	Maintenance	53
	7.3	Replacing the battery in MANTIS	53
	7.4	Warranty	54
8.		GLOSSARY	55
9.		Index	56

1. INTRODUCTION TO MANTIS



Your MANTIS User Manual is divided into the following main chapters.

1 Introduction to MANTIS. This chapter provides an overview of the MANTIS computer and describes its operating modes and functions when on the surface.

2 MANTIS as a watch. This chapter describes MANTIS when it is used as a watch.

3 MANTIS as a dive computer. This chapter describes all settings and functions of MANTIS as a dive computer and takes you underwater with MANTIS. It's about everything MANTIS can and will do to enhance your safety and fun underwater.

4 MANTIS accessories. This chapter briefly describes the extras that can be purchased as additional options to get the most of your dive computer in all diving conditions.

5 MANTIS PC interface. This chapter is about linking MANTIS to your PC/MAC. It describes how to change settings, plus how to download and manage your logbook.

6 Taking care of MANTIS. This chapter describes how you should take care of MANTIS after underwater adventures and also summarizes the main technical information of this instrument.

MANTIS is a technologically-advanced instrument that can accompany you during your underwater adventures while providing you with accurate depth, time and decompression information. On the surface its size makes it your ideal everyday companion. With features such as wake-up alarm, stop watch, barometer, altimeter and swim mode, MANTIS can tackle almost every possible task.

The buttons allow you to initiate operating functions, make setting changes and access menus while on the surface. During the dive they set bookmarks, show further information on the computer screen and activate the backlight.

It is time to dive into the details now. We hope you will enjoy getting to know your new computer and we wish you many happy dives with MANTIS.

1.1 Battery

MANTIS uses a CR2032 battery which is available at your Authorized SCUBAPRO dealer. MANTIS will alert you when the battery is approaching a critical discharge level by displaying the battery symbol.

A steady symbol means that the battery is low, with some reserve left. At this point the backlight cannot be activated. If the symbol blinks the battery level is dangerously low and the backlight and alarm tones cannot be activated; diving is not recommended before replacing the battery.



⚠ WARNING

Starting a dive when the battery symbol is blinking can cause the computer to fail during the dive! Replace the battery before any diving activity if the blinking battery symbol appears. When the 'do not dive symbol' appears along with the battery symbol MANTIS cannot be used for diving before a fresh battery is installed.

Please refer to the chapter on **Checking the battery status** for details how to manually trigger the battery level check.

⚠ WARNING

Replacing the battery requires opening the electronic compartment of MANTIS. You must take extreme care when performing the battery change operation in order to ensure the water tightness of the watch. Failing to do so will cause the watch to flood during your next dive and permanently ruin it. Damage to MANTIS due to an improper battery replacement is not covered by warranty. We strongly recommend having the battery change operation be carried out by your SCUBAPRO dive retailer.

See chapter **Replacing the battery in MANTIS** in this manual for information on how to replace the battery.

2. OPERATION MODES

The reference point for any description of MANTIS as a watch is the main time of day display. This is the display in which the current time is shown on the middle row. The upper row shows the day of the week and the date. The example below shows Thursday, 20th of March and the time is 34 minutes and 9 seconds past 11 o'clock.



The different menu modes are written at the display like for example: "Watch set". Each mode may have sub functions and menus. You can scroll between menus by pressing +/UP or -/DOWN buttons. Note that although Menu is written on the display, you still have not activated the mode. By pressing the SEL button you activate the mode and get into the sub menus.

The modes are grouped and described in this manual in three chapters:

1. MANTIS as a watch
2. Menus and functions at the surface
3. MANTIS as a dive computer

The following chart describes the main menu structure.

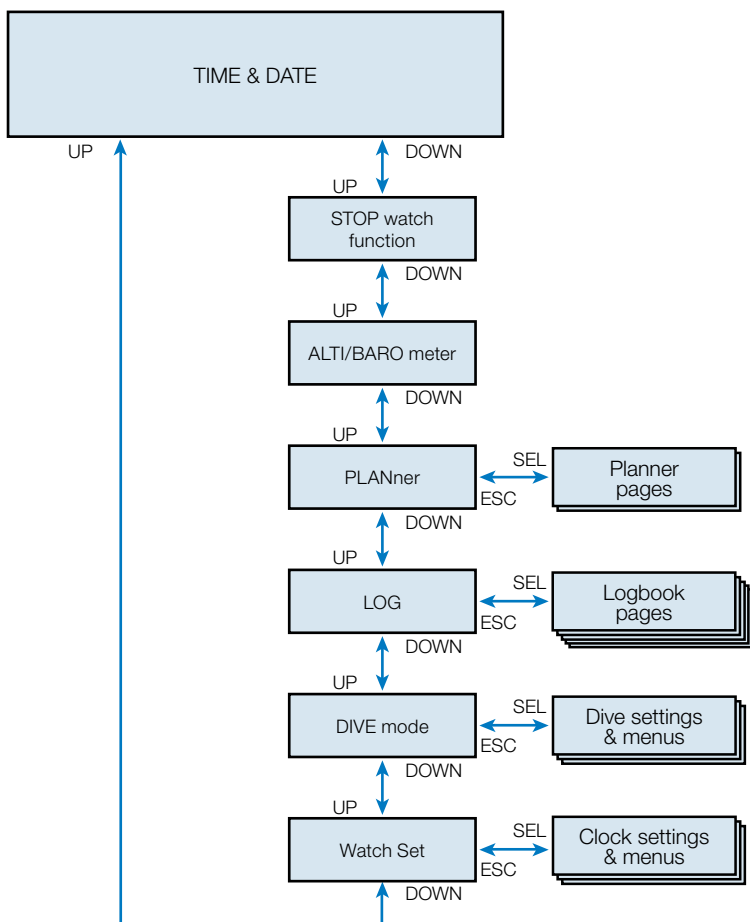

3. MANTIS AS A WATCH

MANTIS is more than just a watch. It features:

- Wake-up warning function.
- Swim mode.
- Stopwatch with lap time and 72 hours run time.
- Altimeter for tracking your excursions to the mountains.
- Thermometer and barometer for current weather conditions.

 **NOTE:** Thermometer reading - when worn at the wrist against the skin the reading is influenced by body heat.

The function of the buttons **on the surface** is summarized in the table below and explained in detail in the following sections.

Light button, Top Left:	Press = backlight
+ /UP button, Top Right:	+ /UP = adds numerical values, scrolls up in the menus
- /DOWN button, Bottom Right:	- /DOWN = subtracts numerical values, scrolls down in the menus
SEL/ESC button, Bottom Left:	Press = select, Press and hold = escape (return to previous menu or cancel the setting)

3.1 Clock setting functions

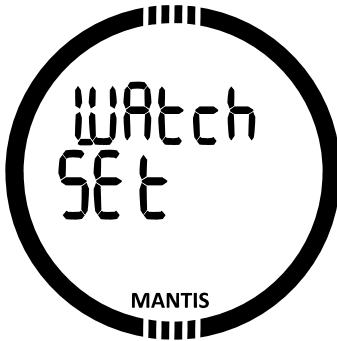

By pressing the - /DOWN button once from the main time and date display and selecting the “SET” menu by pressing the SEL button you will get into the clock settings (See chart below).

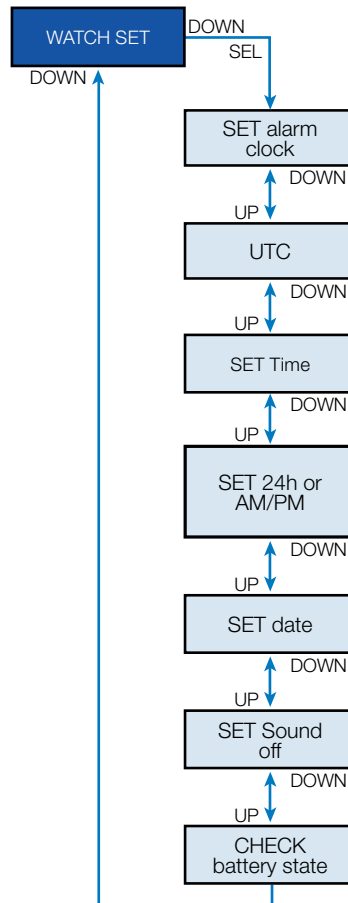

The different sub menu functions are described in later chapters.

3.1.1 Setting the alarm clock

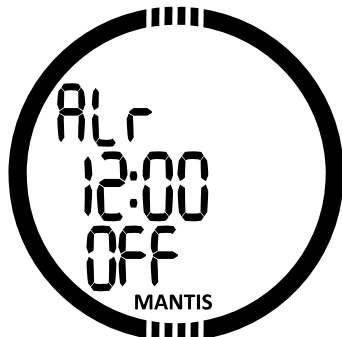

By pressing the SEL button the hours of the alarm will start blinking.

You can scroll the hours setting by pressing +/UP or -/DOWN buttons. Pressing the SEL button will confirm the hour setting and start the minutes blinking. You can scroll the minutes of the alarm setting by pressing +/UP or -/DOWN buttons. Pressing the SEL button will confirm the minutes setting and start the alarm status blinking. The alarm status setting can be selected to either On or Off by pressing +/UP or -/DOWN buttons. Pressing the SEL button will confirm the alarm status setting.

 **NOTE:** The sound off setting does not affect the alarm clock. However, the intelligent battery stretching algorithm disables all warning tones when there are less than 2 dots left in the battery status display or when the battery symbol is blinking in other displays.

3.1.2 Setting the UTC

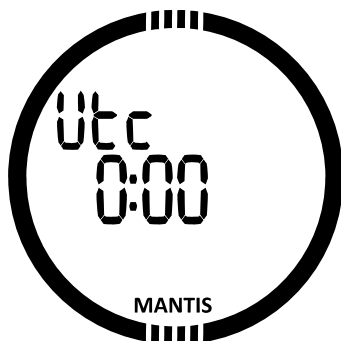

The UTC setting will change the shown time compared to Greenwich 0-Meridian. This feature is practical when travelling through different time zones.

By pressing SEL the hours will start blinking. You may edit them with +/UP or -/DOWN buttons in a range of +14h.-13h. By pressing SEL the minutes will start blinking and you may edit them with +/UP or -/DOWN buttons in 15 minute steps. The UTC setting will be confirmed by pressing the SEL button.

3.1.3 Setting the time

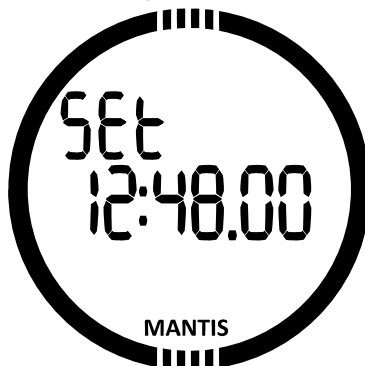

In the display above the current time is shown on the display.

By pressing the SEL button the time setting will be activated: hours start blinking and seconds will turn to 00. You may change the hours with +/UP or -/DOWN buttons. By pressing the SEL button the selection will change to minutes and can be edited the new time setting will be confirmed by pressing the SEL button.

 **NOTE:** seconds cannot be edited; they always start counting from 0.

3.1.4 Setting 24h or am/pm mode

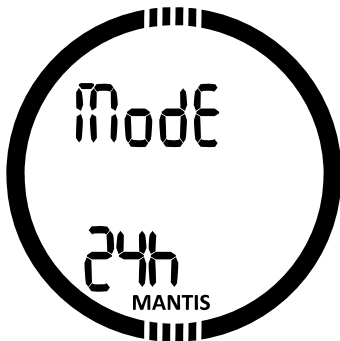

By pressing the SEL button the 24h or 12h setting on the bottom row starts blinking. You may change the setting by pressing +/UP or -/DOWN buttons. By pressing the SEL button the mode will be confirmed.

3.1.5 Setting the date



By pressing the SEL button the first two digits start blinking. In 24h mode the first digit are days, in 12h mode the month is first. You may change them by pressing +/UP or -/DOWN buttons. By pressing the SEL button the next two digits start blinking and you may change them by pressing +/UP or -/DOWN button. Again, by pressing the SEL buttons, the year, after the dot, starts blinking. By pressing SEL button the date will be confirmed.

3.1.6 Setting the sound off (silent mode)



ON/ATT/ALR/OFF

By pressing the SEL button the current setting will start blinking at the bottom row. By pressing +/UP or -/DOWN buttons you may select between the normal mode (ON) where alarm and button tones are on, or the silent mode (OFF) where all tones are off, or alarm mode where **only** alarm tones are on (**ALR**), or attention mode (ATT) where alarm and attention tones are on. The sound off selection is protected with a code.

3.1.7 Accept code protection

When code protection is required the first digit starts blinking. By pressing +/UP or -/DOWN buttons the number can be changed and by pressing the SEL button the number will be stored.

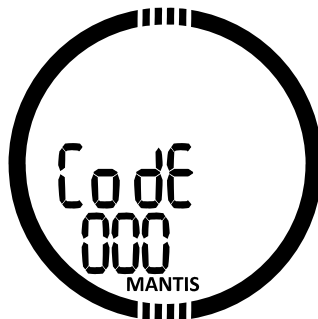

The protection code is: 313.

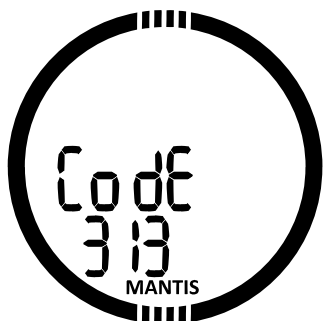

⚠ WARNING

The Sound Off selection will disable all audible dive mode alarms and warnings. This is potentially dangerous.

☞ *NOTE: The only exception to the silent mode is the alarm clock, which will beep when activated, even if the main setting is: sound off.*

3.1.8 Checking the battery status

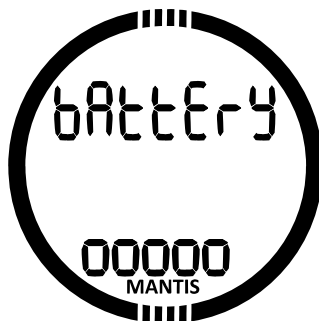

The battery status menu shows how much energy is left in the CR2032 battery. A fresh battery shows 5 dots.

MANTIS is periodically measuring the battery status and you can manually trigger a measurement by pressing the SEL button in this menu.

The intelligent battery algorithm will limit some functions towards the end of the battery lifetime. See the table below for the status and functions.

Indicator in battery status display	At other displays	Battery status	Function limitations
00000		Fresh battery	none
0000_		Battery ok for diving	none
000__		Battery ok for diving	none
00__	Battery symbol	Weak battery, change to fresh	Backlight not operating
0__	Blinking battery symbol, no dive symbol	Completely used battery, change to fresh	Alarms and Backlight not operating, diving not recommended
change battery	Blinking battery symbol, no dive symbol	Completely used battery, change to fresh, watch may make a reset any time and remain off	Diving mode not allowed, only watch is active. Settings cannot be changed (OFF)

☞ *NOTE: Battery capacity and voltage at the end of the lifetime may vary between battery manufacturers. Generally operation at low temperatures decreases battery capacity. Therefore, when the battery indicator drops below 3 dots, change the battery to a fresh one before making any new dives.*

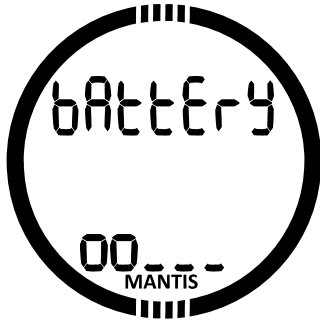

⚠ WARNING

When battery is critically low, the watch and dive settings are disabled (menu off).

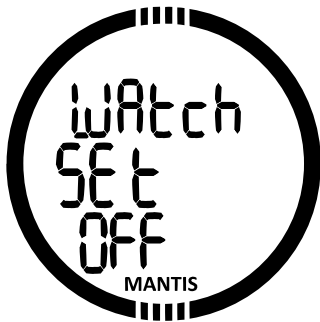

3.2 Menus and functions at the surface

By simply **pressing** +/UP or -/DOWN buttons from the **time of day** display you can scroll through the various menus in MANTIS. The diagram below shows the sequence of the menus. Note that when you first reach a menu, you are not yet inside it, you must press the SEL button to enter the actual menu.

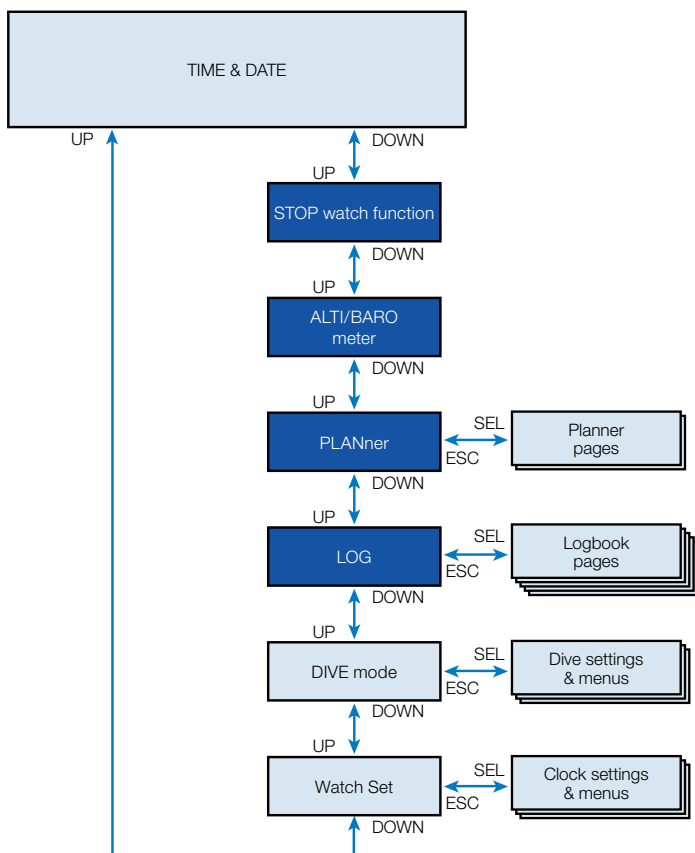

3.2.1 Using the stopwatch



By pressing SEL button the stopwatch will be activated. In the first display the stopwatch shows the status, which can be stop, run or lap. By activating the stopwatch first the time display will be as shown below.



Press +/UP button and the stopwatch starts counting and shows actual state which is: run. By pressing +/UP button again the stop watch stops counting and shows actual state: stop. The counted time will stay on the display.

Stopwatch will reset the counted time when +/UP button is pressed and held.



The laps can be marked by pressing -/DOWN button when stopwatch is counting. By doing so the display will freeze for 5 seconds and MANTIS shows the lap time. Counting will continue automatically and the lap counter will show the number of laps at the bottom of the screen.



When stopwatch is stopped you can review your lap times from the memory by pressing -/DOWN button.



By pressing SEL button you can exit the stopwatch and return to the Stopwatch menu.

NOTE: You can leave the stopwatch actively counting or you can leave the stopped time on the display. The status will be stored in memory allowing you to continue from the same display at a future time.

NOTE: Stopwatch has a 30 minute timeout before reverting to normal watch display. However, the timeout does not stop the stopwatch function. You can return to the stopwatch menu and continue with the time taking task just as you did before the timeout happened.

3.2.2 Reading the altitude, barometer and temperature values



In the altitude menu the current altitude is calculated from the barometric pressure and is shown on the middle row. The current temperature is shown on the bottom row. The current altitude class is shown on the top row.

NOTE: barometric pressure is a variable, changing with weather and atmospheric pressure at that particular elevation. The Dive algorithm uses Altitude Classes which are directly derived from the barometric pressure. Altitude is counted from the current barometric pressure and it is therefore a relative value.

3.2.3 Planning a dive

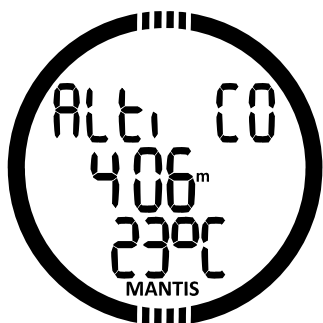

By press and hold the **-/DOWN** button the display changes and shows on the bottom row the barometric pressure at sea level. Or, press and hold the **+/UP** button and you get the barometric pressure in mbar at current altitude. This Barometer feature allows you to foresee the approaching weather in the upcoming hours if your altitude remains the same.

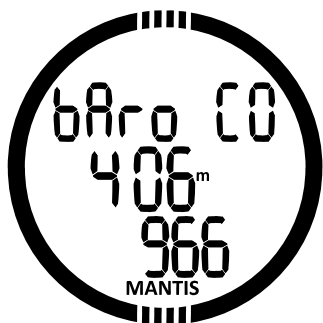

The altitude can be adjusted when current elevation is known by pressing the **SEL** button. The altitude value will start blinking. By pressing **+/UP** or **-/DOWN** buttons the value can be adjusted in 10m/50feet increments. Adjusting the altitude elevation has no effect on the Altitude Class.

 **NOTE:** Different combinations *m&°C*, *Ft&°C*, *m&°F* or *Ft&°F* can be selected from the Dive mode menu: Units.

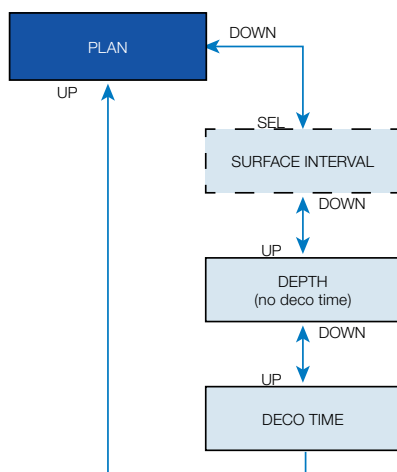
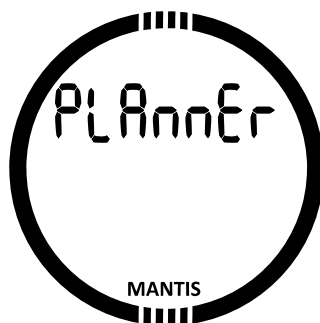

You can plan your next dive based on your body's nitrogen saturation. The planner is also using the following information.

1. Selected oxygen concentration.
2. Enabled gases (multi gas diving).
3. Selected water type.
4. Selected microbubble level.
5. Water temperature of the most recent dive.
6. Altitude range.
7. Status of saturation at the time when the planner is started.
8. Observation of the prescribed ascent rates.

NOTE: When MANTIS is in GAUGE or APNEA modes the Planner is disabled and this is indicated by showing OFF in this menu.

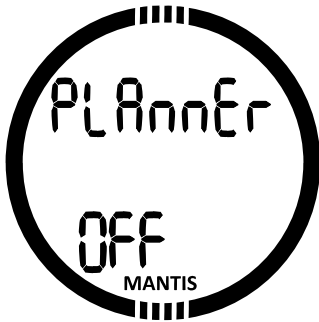

By pressing the SEL button in the planner menu you will get into the Planner directly or an after repetitive dive to the surface interval setting.

In case you plan to make a second dive during the desaturation phase, you must start the Planner by inputting the time you would still stay at the surface.



By pressing the +/UP or -/DOWN buttons you can set the time in 15 minutes increments. The prohibited altitude is shown on the top row. By increasing the surface interval the allowed limit will reach maximum (level 4). To learn more about altitude diving with MANTIS refer to the chapter **Altitude diving**.

In case MANTIS is displaying the no-dive warning, the duration of the warning itself is displayed as recommended surface interval for planning purposes (rounded up to the nearest 15-minute increment).

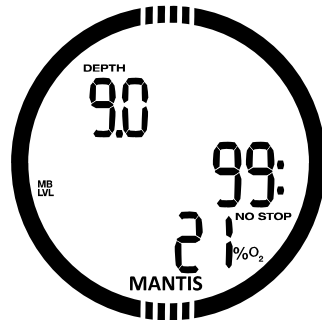

When the surface interval is given or if you have no remaining desaturation left, the planner will start blinking the depth. By pressing +/UP or -/DOWN you can set the depth in 3m/10feet increments. Minimum depth for planning is 9m/30feet. The no decompression dive time for given depth is shown on the middle row.

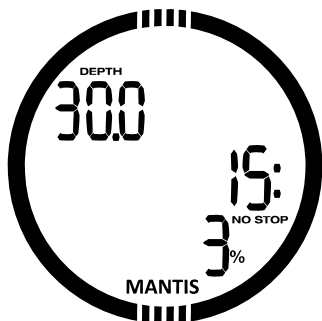

The gas O_2 content is shown on the bottom row until the 1% CNS for the planned depth is reached. After that the planner shows the CNS% on the bottom row.

The planner allows only depths according to maximum ppO_2 . The gas oxygen content and maximum ppO_2 settings are given on the dive set menu (described in chapter **Set Gas 1, 2 or d**).

⚠ WARNING

if you have set the $ppO_{2,max}$ to OFF, the planner will allow depths up to maximum of 120m/394ft. Air/nitrox dives with high ppO_2 are extremely dangerous and can lead to fatal injury. Be aware that exposures to high ppO_2 will lead the CNS clock value to exceed the maximum recommended 100%.

👉 NOTE: If MOD is shallower than 9m/30feet, planning is not allowed and information LO MOD is shown.

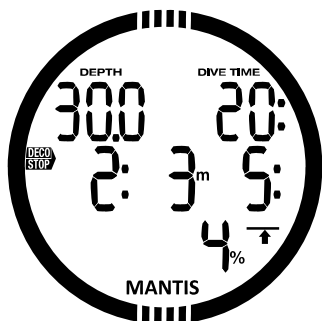

By pressing SEL for planned depth the dive time starts blinking. The start point (minimum now) is the no decompression time. By pressing +/UP or -/DOWN buttons

you may change the time in 1 minute increments. Decompression time and total ascent time are shown on the middle row.

By pressing the SEL button the planner will exit and you will get back to the main menu.

3.2.4 Reading the logbook

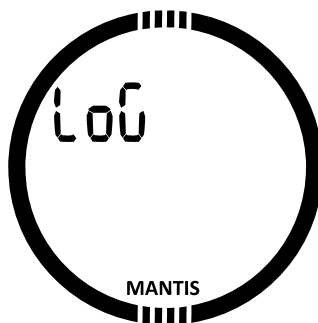

You can check the main information about your dives from the Logbook of the MANTIS. The first page shown is the dive history.

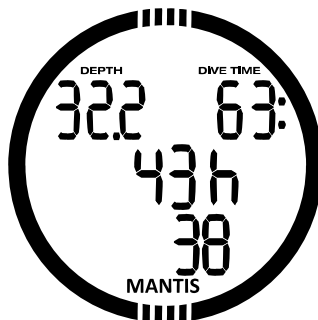

On the display above, the MANTIS has 38 dives and a total of 43 hours of diving stored in the Logbook, with the deepest dive at 32.2 meters and the longest dive time of 63 minutes.

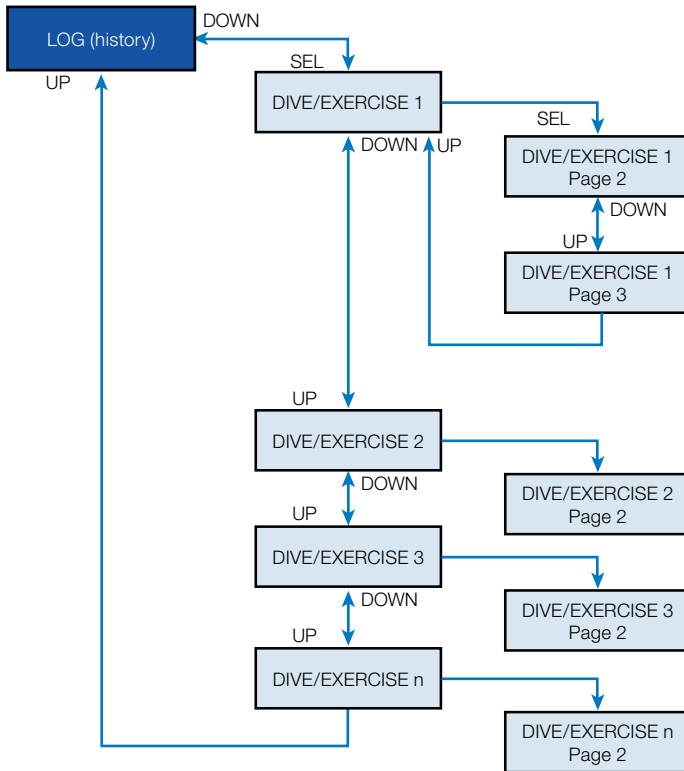

3.2.4.1 Scuba log

By pressing the +/UP button you get to latest dive / exercise session, and by pressing +/UP or -/DOWN buttons you can scroll the logs in memory. In SCUBA mode there is a main page showing date (display below shows 28th August 2013), immersion time (10:27.38), dive log number (9) and used oxygen content (32%). In this display a too fast ascent, used MB level or desaturation reset can also be shown.



 **NOTE:** If the dive has been done in GAUGE or APNEA modes, or if exercises at the surface have been logged, then the main page will show GA, AP or SE instead of O₂% on the bottom row.

By pressing the SEL button you will select the dive and get to the sub display which shows the following information in SCUBA mode:

Dive depth (display below 18.0m), dive time (38 minutes), minimum temperature (21 °C), deco gas (50%). In this display a SOS mode can be identified if the last dive was terminated without correct decompression stops.

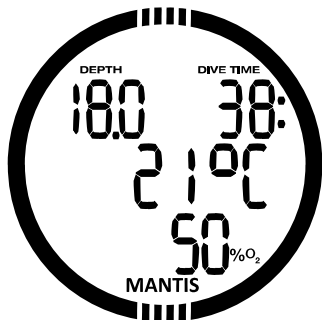

3.2.4.2 Apnea log

MANTIS organizes the APNEA dive training in a special way for easier data reading. The repetitive APNEA dives are grouped in a specific section and the main page shows the first immersion date and time.



By pressing the SEL button, the APNEA dive session opens. The dives are shown in repetitive order (display below 1 dive), with max depth (8.5m) and time (58 seconds). On the bottom row the APNEA dive number of that session is shown.

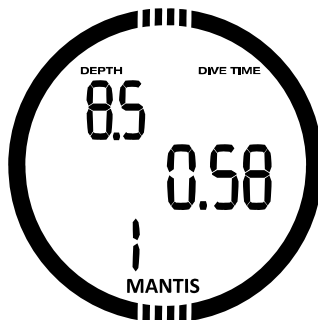

By pressing the +/UP or -/DOWN buttons the dives in the current session can be scrolled.

3.2.4.3 Surface exercise logs

MANTIS has a swim mode. The log appears as SE (Surface Exercise) for exercises done on the surface.



The log book will present the start time and date on the main page. By pressing the SEL button you can review (see display below) the distance (1238m), exercise time (38 minutes 53 seconds) and average heart rate (128 beats/minute).



4. MANTIS AS A DIVE COMPUTER

MANTIS is a full-featured diving computer, capable of multigas Nitrox decompression calculations, CCR mode, ascent rate calculations and warnings. The logbook can store up to 50 hours of dive profiles with a 4s sampling rate. During the dive MANTIS displays information such as depth, dive time, decompression status, water temperature and much more. On the surface after a dive, remaining desaturation time, no-fly time, surface interval and prohibited altitude classes are shown in addition to the watch functions.

4.1 Settings in the dive mode at surface

When MANTIS is in **surface** mode, you can access various menus dedicated to diving and customize various settings to your liking.

The dive computer functions of MANTIS on the surface include, among others, setting the oxygen concentration for Nitrox diving, setting the MB level of the decompression algorithm, setting various warnings and personal preferences. To reach any of these functions, MANTIS must be in Dive surface mode display. This can be reached from the time of day display by pressing -/DOWN button twice.

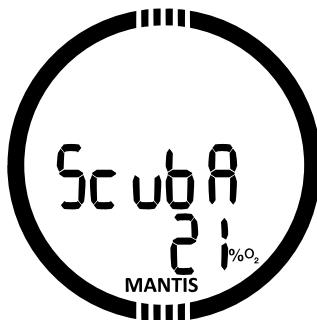

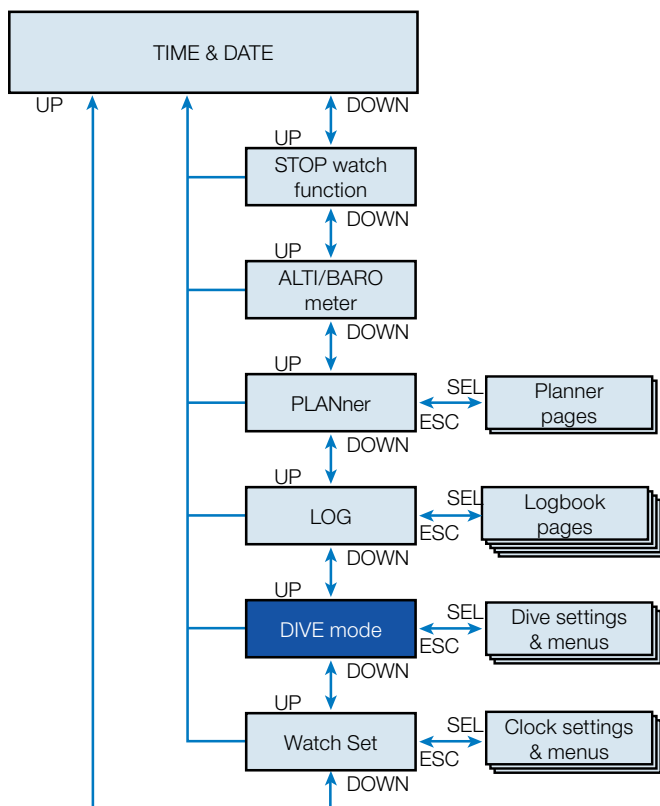

When you have not been diving with your MANTIS for a while (no desaturation time left) the dive mode may appear as shown below:

Remaining desaturation time on the middle row, no repetitive dive time and allowed altitude classes on the top row.

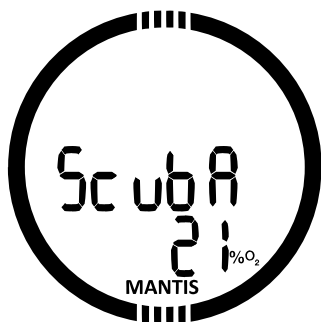

However in SCUBA mode after a dive, the display may appear as shown below:

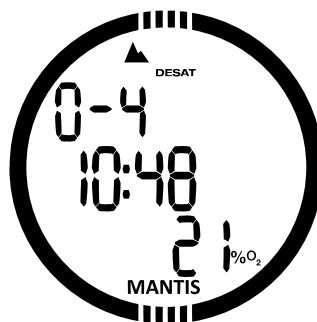

From here, by pressing the SEL button and scrolling with the +/UP or -/DOWN buttons, you gain access to a loop of menus which are all related to diving.

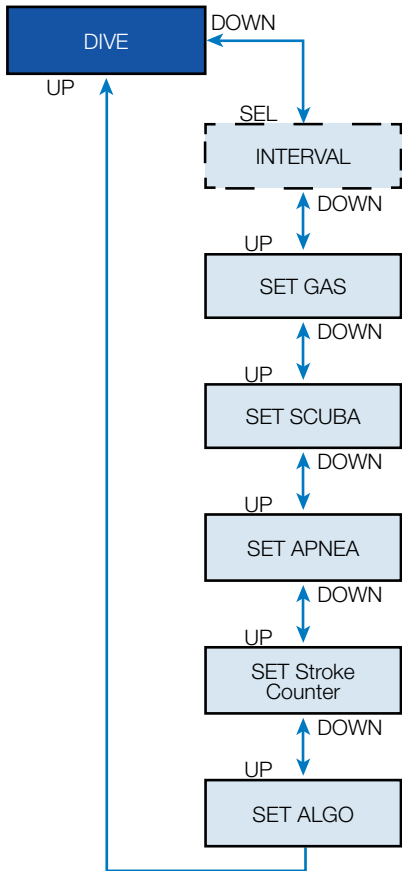

4.1.1 Surface interval counter

After a dive the MANTIS shows the surface interval from the latest dive. The surface interval counter counts until desaturation is complete. After the desaturation is complete this menu disappears.

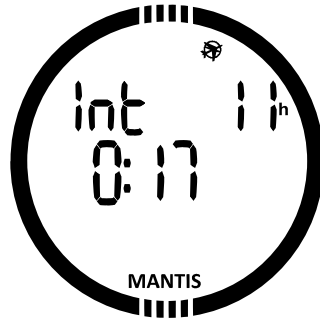

The remaining CNS% is shown on the bottom row and the no fly time is shown in hours until this restriction is completed on the top row.

4.2 Gas settings



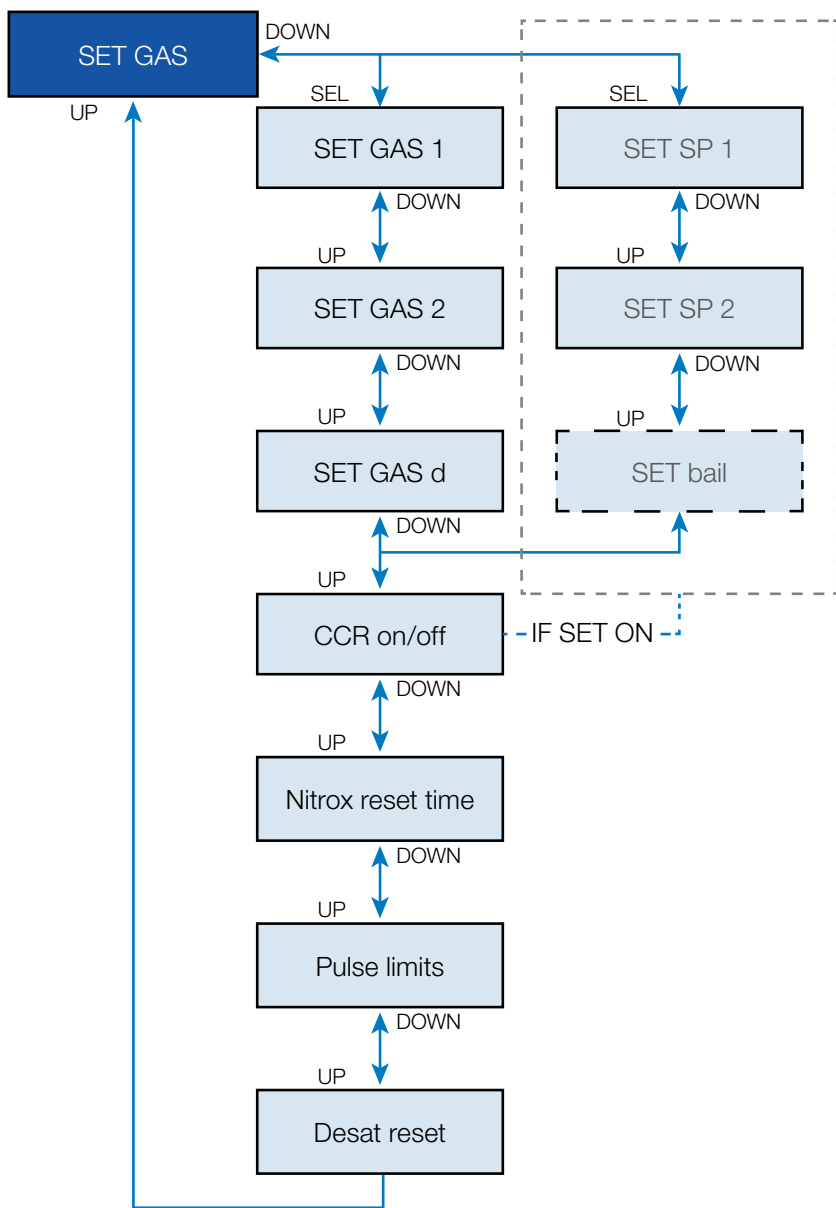

4.2.1 Set Gas 1, 2 or d

You may use your MANTIS with all Nitrox mixes from Air to pure oxygen.

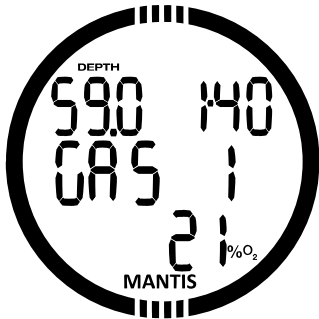

By pressing the SEL button in this display the oxygen content of the Gas starts blinking. By pressing the +/UP or -/DOWN buttons you may scroll the value from 21 up to 100%.

By pressing SEL the content is confirmed and the ppO₂ starts blinking. By pressing the +/UP or -/DOWN buttons you may select the value from 1.00 bar up to 1.60 bar.

It is possible to disable the MOD setting for Gas 1 (depth «---» displayed on the top row), but this requires the security code 313 from the user. By pressing the SEL button the user will accept the given value.

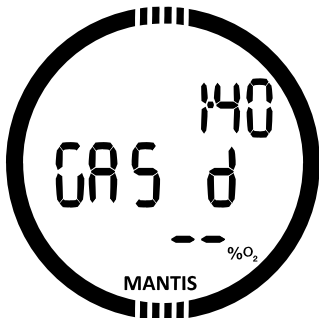

Refer to the chapter **Diving with two or more gas mixtures** for more information on using Gas 2 and d. Setting Gas d or Gas 2 are similar to Gas 1. Gas 2 can only be set if Gas d is enabled and set.

NOTE: Diving with a ppO₂ higher than 1.4 is dangerous and may lead to unconsciousness, drowning and fatal injury.

NOTE: ppO₂ is fixed to 1.60 bar when selected oxygen content is 80% or higher.

Enabling the CCR mode will change the Gas 1 and Gas 2 settings to Setpoints and Gas d to bailout. Refer to the chapter **Diving with CCR mode** to learn more about diving with CCR mode.

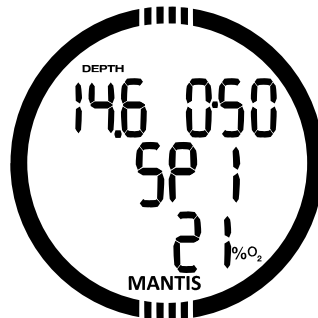

So, when the CCR has been enabled, by pressing the SEL button in this display the oxygen content of the Diluent tank starts blinking. By pressing +/UP or -/DOWN buttons you may scroll the value from 21 up to 40%.

By pressing SEL the tank content is confirmed and the Setpoint 1 (SP1) ppO₂ starts blinking. By pressing +/UP or -/DOWN buttons you may select the value from 0.3 bar up to 0.95 bar. By pressing the SEL button the given values are confirmed.



Setpoint 2 is dedicated to Oxygen tank and the setting procedure is as with Setpoint 1.

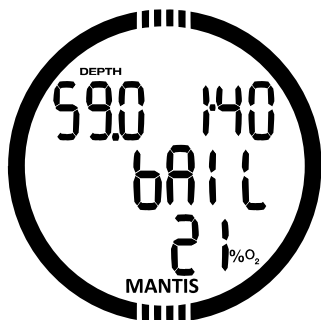

Bailout is an open circuit gas and it is set as the Gas 1.

4.2.2 Enabling the CCR mode

Refer to chapter 5.8.6 to learn more about diving with CCR mode.

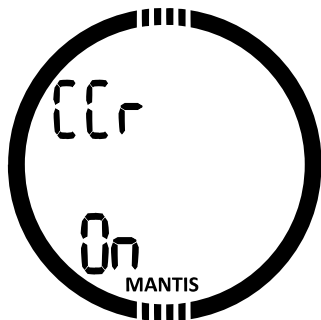

By pressing the SEL button in this display the CCR mode on or off starts blinking and can be selected by pressing the +/UP or -/DOWN buttons. By pressing the SEL button you will confirm the setting.

4.2.3 Nitrox reset time

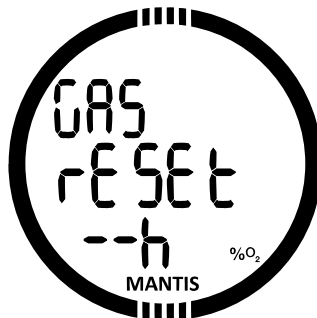

If you are generally diving with air and want to return to this setting after the occasional nitrox dive, you can preset a default time when your MANTIS will reset back to air. By pressing the SEL button the time shown on the bottom row starts blinking. The time can be selected from 1 hour up to 48 hours or the nitrox reset time can be disabled by pressing the +/UP or -/DOWN buttons. Gas reset time is disabled when -- h is shown.

 *NOTE: The Nitrox reset disables the Gas 1 and Gas 2.*

4.2.4 Heart rate limits

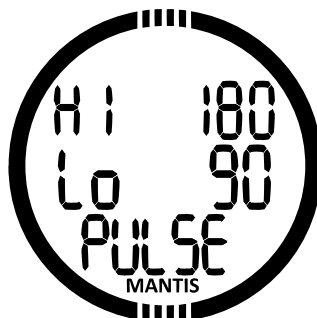

By pressing the SEL in this menu the maximum heart rate (HI) value starts blinking and by pressing +/UP or -/DOWN you may select the limit from 140 up to 220. By pressing the SEL button the base heart rate (LO) starts blinking and by pressing +/UP or -/DOWN you may select the limit from 60 up to 120. A base heart rate should be selected so that it represents normal heart rate during a typical dive.

By pressing the SEL button the PULSE/OFF starts blinking. You may select between these by pressing the +/UP or -/DOWN buttons. By pressing SEL the values will be confirmed.

4.2.5 Desaturation reset



⚠ WARNING

Resetting desaturation will affect calculations of the algorithm and this may lead to serious injury or death. Do not reset desaturation without a solid purpose.

When MANTIS is still counting down the desaturation, some menu changes are not possible. In the event you decides to reset the desaturation, the safety code 313 must be given. This procedure secures unwanted resetting and the desaturation reset will be stored in memory. In the next dive log the desaturation symbol will be shown.

By pressing the SEL button the selection 'on' starts blinking. By pressing the +/UP or -/DOWN buttons the desaturation can be deactivated and this state is indicated with the selection 'off'. When the off state is confirmed by pressing the SEL button the code page appears. The first digit starts blinking and by pressing the +/UP or -/DOWN this can be edited. By pressing the SEL button the number is confirmed and the next number starts blinking. When the code is given correctly and is confirmed by pressing the SEL button, then the desaturation reset is completed.

4.3 SCUBA settings



A set of SCUBA related selections are grouped to this menu.

By pressing the SEL button the following menus can be scrolled down.

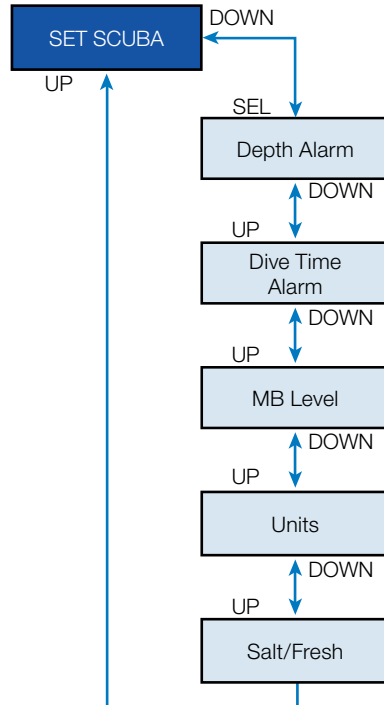

4.3.1 Maximum dive depth alarm

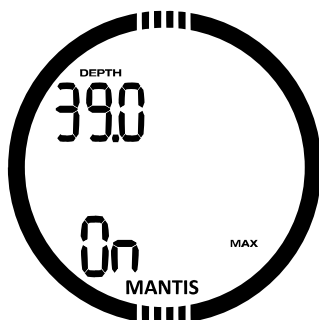

By pressing the SEL button in this menu the depth value starts blinking. By pressing the +/UP or -/DOWN buttons the value can be selected from 5 up to 100 meters (20..330 feet) in 1m/5ft increments. By pressing the SEL button the function starts blinking and you may select on or off by pressing the +/UP or -/DOWN buttons. The selection is confirmed by pressing the SEL button.

4.3.2 Maximum dive time alarm

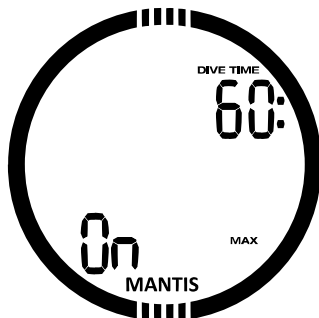

By pressing the SEL button in this menu the time value starts blinking. By pressing the +/UP or -/DOWN buttons the value can be selected from 5 up to 195 minutes in 5 minutes increments. By pressing the SEL button the function starts blinking and you may select on or off by pressing the +/UP or -/DOWN buttons. The selection is confirmed by pressing the SEL button.

4.3.3 Setting the Micro Bubble level

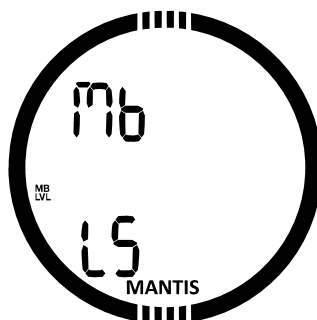

By pressing the SEL button in this menu the Micro Bubble level starts blinking. By pressing the +/UP or -/DOWN buttons you may select personal setting from L0 up to L5 which is the most conservative setting. The selection is confirmed by pressing the SEL button.

 **NOTE:** More about diving with the MB levels, can be found in section: **Diving with MB levels.**

4.3.4 Units

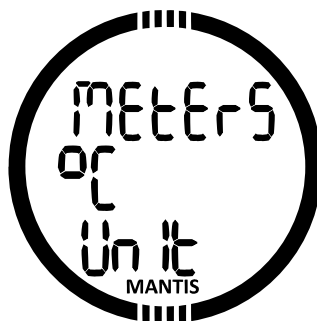

You may select between depth and temperature unit combinations. The effect takes place in dive mode, in the log book, alarm settings, altitude settings etc.

By pressing the SEL button the depth field starts blinking and the value may be changed between meters/feet by pressing the +/UP or -/DOWN buttons. By pressing the SEL the temperature units start blinking and the value can be changed between °C/°F by pressing the +/UP or -/DOWN

buttons. By pressing the SEL button the unit settings will be confirmed.

4.3.5 Selecting the salt (sea) or fresh water



MANTIS determines the depth by measuring pressure using water density as a constant. 10m/33ft depth in salt water corresponds to approximately 10.3m/34ft in fresh water.

NOTE: This setting will adjust the depth on all modes: SCUBA, GAUGE and APNEA.

By pressing the SEL button in this menu the salt water on/off setting on the bottom row of the display starts blinking. You may scroll between these two settings by pressing the +/UP or -/DOWN button and confirm your selection by pressing the SEL button.

4.4 Apnea settings

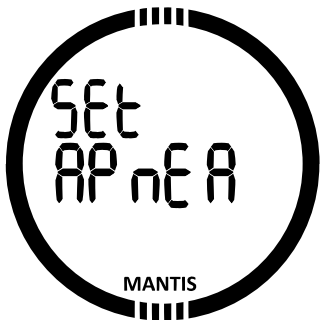

Apnea diving related selections are grouped in this menu.

By pressing the SEL button the following menu's can be accessed.

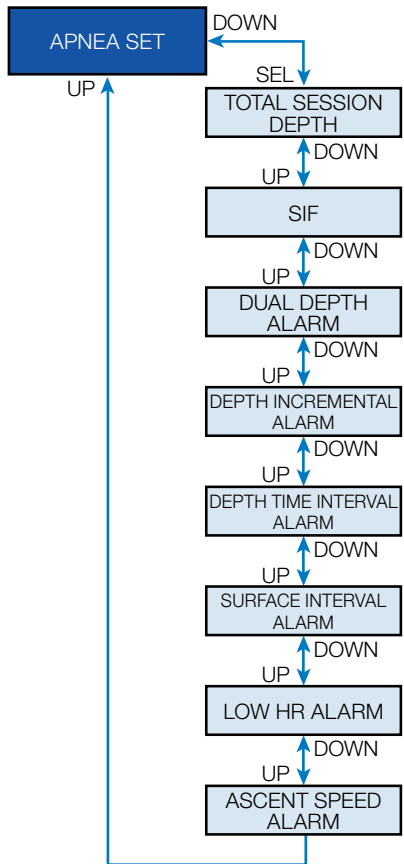

4.4.1 Setting the apnea session total depth



To give a scale of total pressure changes during an apnea dive session, MANTIS includes a total depth counter. When your depth total has been reached, MANTIS notifies you at the surface with an audible tone and a blinking “no dive” symbol to let you know it’s to end the session and take a break.

By pressing the SEL button in this menu the off/depth selection starts blinking. By pressing the +/UP or -/DOWN button this can be edited from 100 to 1000m in 20m increments (330..3300ft in 65ft increments) and confirmed by pressing the SEL button.

4.4.2 Setting the surface interval factor

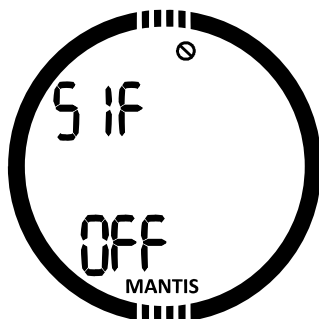

Apnea diving organizations give various recommendations about surface intervals between dives based on dive times or depths. MANTIS integrates a surface interval counter which uses simple multiplication for determining the surface interval in seconds. MANTIS uses following formula in this calculation:

Surface interval before the next dive = pressure (depth) * square root of dive time * SIF

As a reference a few values are listed in the following table:

Dive depth		Dive time	Surface Interval	
m	ft	seconds	seconds (SIF = 5)	seconds (SIF = 20)
10	30	40	63	253
10	30	60	77	309
20	60	60	116	464
30	90	80	178	716
40	120	90	237	949

 NOTE: The actual depth and time are calculated during the ascent and descent, this is not presented in the table above.

By pressing the SEL button in this menu the off/value selection starts blinking. By pressing the +/UP or -/DOWN button the SIF can be selected from 5 to 20 or disabled with the OFF setting which is then confirmed by pressing the SEL button.

After a dive, if SIF is set, MANTIS will indicate the surface interval with a static “no dive” symbol until the time has elapsed which is then followed by an audible tone.

4.4.3 Setting the dual depth alarm

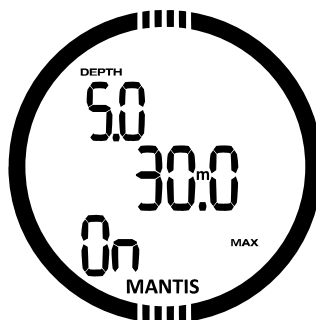

By pressing the SEL button in this menu the first depth starts blinking. By pressing the +/UP or -/DOWN buttons you may select the first depth alarm from 5 to 100 meters (20..330 feet). By pressing SEL the first value is confirmed and the second depth starts blinking. Like the first, by pressing the +/UP or -/DOWN buttons the second

depth alarm may be set from 5 to 100 meters. By pressing the SEL button the on/off selection starts blinking. By pressing the +/UP or -/DOWN button this can be edited and then confirmed by pressing the SEL button.

NOTE: The first alarm is short in sequence to get your attention, and then the second alarm is continuous. By setting the first alarm deeper than the second, it will be masked by the continuous alarm and you will not be able to hear the first one.

4.4.4 Setting the depth incremental alarm

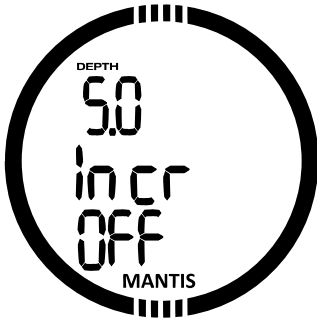

By pressing the SEL button in this menu the alarm depth starts blinking. By pressing the +/UP or -/DOWN buttons you may select the alarm value from 5 to 100 meters (20..330 feet). By pressing the SEL button the incremental mode starts blinking. By pressing the +/UP or -/DOWN the you may scroll between the direction of the alarm or disable it with selections: off, dn (down), up or both. By pressing the SEL button the settings will be confirmed.

4.4.5 Setting the dive time interval alarm



By pressing the SEL button at this menu the time starts blinking and by pressing the +/UP or -/DOWN you can select the interval from 15 seconds up to 10 minutes. By pressing the SEL button the function starts blinking and you may enable or disable it by choosing on/off by pressing the +/UP or -/DOWN buttons. By pressing the SEL again the settings will be confirmed.

4.4.6 Setting the surface interval alarm

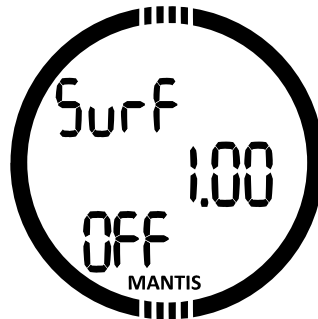

By pressing the SEL button in this menu the surface interval time starts blinking. By pressing the +/UP or -/DOWN buttons you can select the interval from 15 seconds up to 10 minutes. By pressing the SEL button the function starts blinking and you may enable or disable the alarm by selecting on/off with the +/UP or -/DOWN buttons. By pressing SEL again the settings will be confirmed.

4.4.7 Setting the heart rate low limit

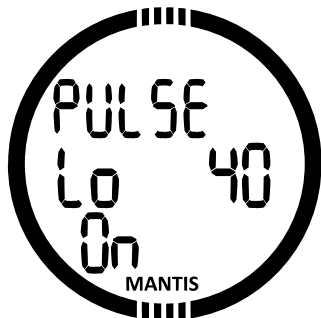

By pressing SEL in this menu the HR low value starts blinking. By pressing the +/UP or -/DOWN buttons you may select the value from 25 to 100 bpm. By pressing the SEL button the function starts blinking and by pressing +/UP or -/DOWN you may select between enabling or disabling the alarm with the on/off setting. By pressing SEL the selection will be confirmed.

4.4.8 Setting the ascent speed alarm

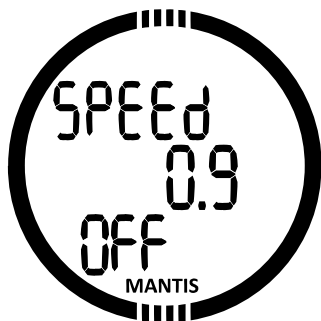

By pressing SEL in this menu the ascent speed starts blinking. By pressing the +/UP or -/DOWN buttons you may select the value from 0.1 to 5.0 meters/second (1..15 feet/second). By pressing SEL the value will be confirmed and the function starts blinking. By pressing +/UP or -/DOWN you may select between enabling or disabling the alarm with the on/off setting. By pressing SEL the selection will be confirmed.

4.5 SWIM mode

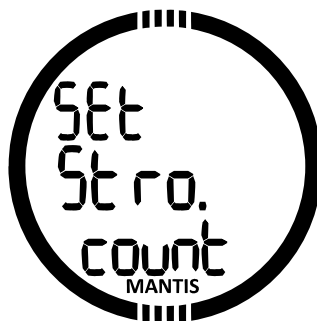

For the Surface Exercise you must set the cycle threshold (how much depth difference is counted as a stroke cycle) and the distance per cycle for the proper result. The following illustration shows the parameters.

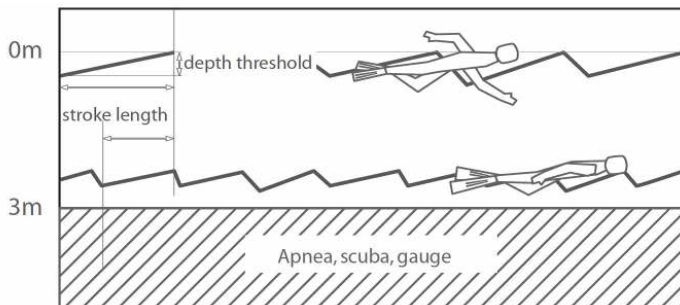

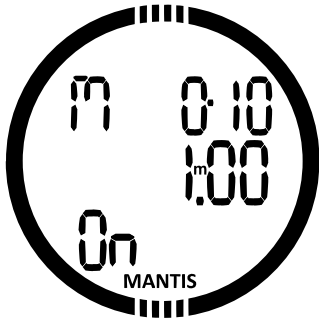

By pressing SEL in the swim menu, you reach the swim mode settings. By pressing SEL the counter stroke threshold starts blinking. A big threshold setting will detect only large movement as a stroke, too small a setting may detect too many strokes. You must test and adjust this according to your style. By pressing the +/UP or -/DOWN buttons the value can be selected from 2cm/1inch to 40cm/16inch. By pressing SEL the distance per stroke starts blinking. You may select the value from 0.5m/2ft to 5.0m/16ft by pressing +/UP or -/DOWN buttons. By pressing SEL the swim mode activation starts blinking and you may scroll between off/on/pulse (with pulse selected, the swim mode is enabled and heart rate is activated) by pressing the +/UP or -/DOWN buttons. By pressing the SEL button the values are confirmed.

4.6 Algorithm selection

You may select your MANTIS operation mode between SCUBA, GAUGE or APNEA modes. When MANTIS has not been submerged for a while the display looks like the illustration below:

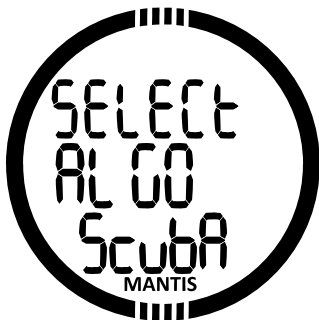

The GAUGE and APNEA modes are not tracking the tissue saturation and there is a locking interval before a change to SCUBA mode is possible. In GAUGE mode the locking interval is 48h after the last dive in GAUGE mode. In APNEA mode there is 12h locking interval with shallower than 5m/16ft and 24h locking interval with deeper than 5m/16ft dives in APNEA mode. MANTIS shown below went for a dive in GAUGE mode and the operation mode cannot be changed for another 13 hours.



The change to GAUGE or to APNEA mode is possible after the desaturation time from the last SCUBA dive has elapsed. If you decide to change modes before the 48h interval or full desaturation you have to go to the desaturation reset menu and perform a manual desaturation reset. By pressing the SEL button in this menu the mode starts blinking. By pressing the +/UP or -/DOWN buttons you may select between SCUBA, GAUGE or APNEA modes. By pressing the SEL button the selection will be confirmed.

4.7 Diving with MANTIS

The functions of the buttons during diving are summarized in the table below.

Note that MANTIS can be set to three dive modes: SCUBA, APNEA and GAUGE. Due to the operational differences between modes, the buttons will have different functions depending on which mode you are using.

LIGHT:	Press = backlight Press and hold = bookmark
SEL/ESC:	Press = accept gas switch Press and hold = start manual gas switch Press and hold in APNEA and SWIM mode = end the dive / exercise
+/UP:	Press = alternative display data Press and hold when SWIM mode active = manual start/ stop of the SWIM mode Press and hold in GAUGE mode = reset average depth counter
-/DOWN:	Press in SCUBA and GAUGE mode = start/stop timer Press and hold in SCUBA and GAUGE mode = reset the timer if it is stopped Press and hold in APNEA mode = manual start and end the dive

4.7.1 Display information

In dive mode, the display shows you are in SCUBA mode, it shows the Gas 1 content (21%) and the amount of other gas mixtures (2G or 3G) if more than one is enabled. The heart rate symbol will blink when HR signal is received.

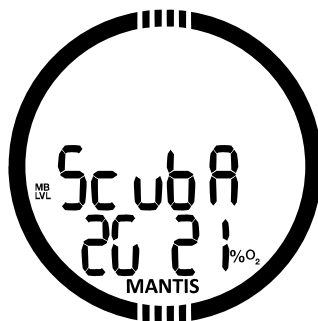

Upon immersion, MANTIS will automatically start to monitor the dive regardless of what state it was in prior to the immersion. Details on the information displayed can be found in the next sections.

Dive time: the dive time is displayed in seconds in APNEA mode and in minutes in SCUBA and GAUGE modes. If during the dive you ascend to the surface, the time spent on the surface will only be counted to the dive time if you descend again below 0.8m/3ft within 5 minutes. This allows for brief periods of orientation. While on the surface, the time will not show as progressing but it is running in the background. As soon as you submerge, the time will resume, including the time spent on the surface. If you spend more than 5 minutes at depths shallower than 0.8m/3ft, the dive will be considered ended and will be stored in the logbook. Any subsequent immersion will cause the dive time to start again from zero.

Maximum displayed time is 999 minutes. For dives longer than that, the dive time starts again from 0 minutes.

Depth: the depth is given in 10cm resolution when in metric mode. When the depth is displayed in feet, the resolution is always 1 foot. At a depth shallower than 0.8m/3ft, the display shows --. Maximum operating depth is 120m/394ft.

No-stop time: calculated in real time and updated every 4 seconds. Maximum displayed no-stop time is 99 minutes.

▲ WARNING:

During all dives, perform a safety stop between 3 and 5 meters/10 and 15 feet for 3 to 5 minutes, even if no decompression stop is required.

Temperature: MANTIS displays the water temperature during the dive and the air temperature when on the surface. However, skin temperature influences the measurement when worn on the wrist.

Decompression information: when MANTIS calculates the need for a mandatory decompression stop, it shows you how long and how deep your deepest stop is. It also gives you the total ascent time. Stops deeper than 27m/90ft and total ascent times longer than 99 minutes are shown as “- -”.

4.7.1.1 Display configuration during the dive

Throughout the dive, MANTIS displays the most important information on the top row: current depth (left), elapsed dive time (right). The no-stop or decompression information is presented in the middle row.

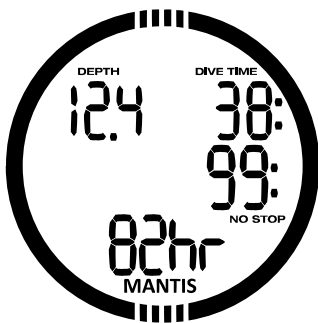

MANTIS utilizes the bottom row to display additional information regarding the dive. By pressing the +/UP button the display shows, in sequence:

1. Maximum depth (only if 1m/3ft ascent detected)
2. HR
3. Water temperature
4. Actual tank O₂ %
5. Actual tank MOD
6. Actual MB Level
7. MB Level 0 deco time

8. CNS %
9. Time of the day
10. Stop timer
11. Skin temperature
(from SCUBAPRO HR belt)

4.7.1.2 Skin temperature

Water conducts heat approximately 20 times faster than air. Even with the best thermal isolation the body heat is lost through the large skin area and as a consequence body regulates blood circulation in the skin and at the extremities to maintain the body's core temperature.

Past recommendations to add more conservatism to cold water dive profiles was based on the water temperature and/or a dive suit thermal isolation estimation. Now, SCUBAPRO has taken the next step in diving and presents a new patented wireless technology for measuring the temperature underneath the thermal isolation layer.

Skin temperature is measured inside the SCUBAPRO heart rate belt. The heart rate belt is located at the mid-torso which is the ideal location for estimating skin temperature independent of the type of dive suit being worn. The temperature is modulated to the belt transmission signal and the dive computer shows and uses this information in SCUBAPRO's adaptive dive algorithm.

The temperature measured inside of the heart rate belt has a range of +18..36°C (64..97°F) in 1°C resolution. The SCUBAPRO heart rate belt can be used with wet or dry suits.

☞ NOTE: Heat vests with a heating element that overlays the SCUBAPRO heart rate belt or other active heating suits cannot be used with skin temperature heart rate belts.

4.7.1.3 Stop timer

There are many situations during a dive where a simple stop timer, independent of dive time, is practical; for example timed tasks on dive courses or special missions, etc. MANTIS offers a stop timer in SCUBA mode. The stop timer can be selected by pressing the +/UP button and it is shown on the bottom row of the display screen.

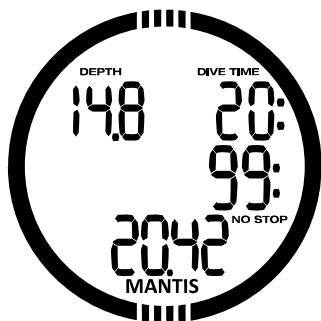

During a dive, the stop timer starts at immersion. So when displayed for the first time during the dive, the stop timer and dive time are identical.

When displayed, the stop timer can be stopped by pressing the -/DOWN button. This creates a bookmark, which can be seen in the log book using PC/Mac interface software

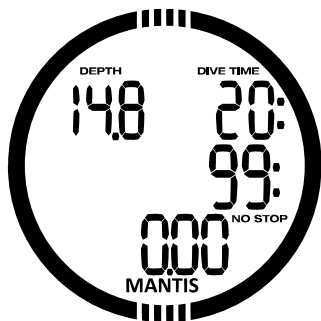

When displayed and stopped, the stop timer can be reset to zero by a press and hold of the -/DOWN button.

4.7.1.4 Setting bookmarks

By a press and hold of the "LIGHT" button you can set any number of bookmarks as reminders of particular moments during the dive. The bookmarks will appear on the dive profile in SCUBAPRO LogTRAK.

4.7.1.5 Safety stop timer

If a minimum depth of 10m/30ft is reached during the dive, at a depth of 5m/15ft the safety stop timer will automatically start a 3-minute countdown. If you go below 6.5m/20ft, the timer will disappear and

the no-stop time is shown again. Upon returning to 5m/15ft, the timer will start again automatically.

4.7.1.6 Activating the backlight

To activate the backlight, **press LIGHT**. The duration of the backlight is 10 seconds.

 **NOTE:** The backlight is not available when the **BATTERY CHANGE** warning appears.

4.7.1.7 Diving with mb levels

Microbubbles are tiny bubbles that can build up inside a diver's body during any dive and normally dissipate naturally during an ascent and on the surface after a dive. Dives within no-stop times or that observe of decompression stops do not prevent the formation of microbubbles in the venous blood circulation. MANTIS is equipped with an enhanced SCUBAPRO algorithm, named ZH-L8 ADT MB, that has been designed to reduce the formation of these microbubbles.

This enhanced algorithm allows the user to choose a level of conservatism that exceeds the worldwide proven safety record of the standard ZH-L8 ADT algorithm. There are five levels of additional conservatism (or MB levels) that can be programmed into the MANTIS, from L1 to L5, with L5 being the most conservative and L1 being just a bit more conservative than the standard ZH-L8 ADT, here referred to as L0.

Choosing an MB level between L1 and L5 makes the algorithm more conservative, therefore you will have either shorter no-stop times or deeper and longer decompression stops than when diving at L0. Consequently, the body will either take up less nitrogen (shorter no-stop dives) or will be able to off-gas more before returning to the surface. Both work towards reducing the amount of microbubbles present in the body at the end of the dive.

Please refer to the chapter **Setting the Micro Bubble level** for information on setting the MB level.

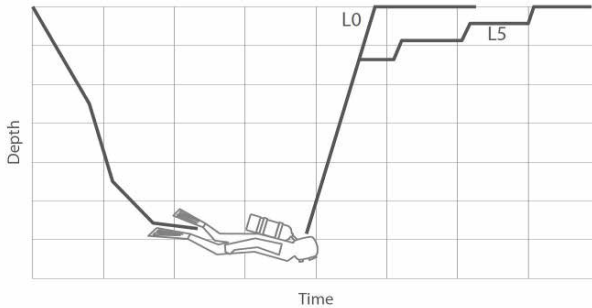

4.7.1.8 PDI stops

MANTIS is equipped with the innovative Profile Dependent Intermediate Stops which is available on other SCUBAPRO dive computers.

The PDI Stop optimizes the leading compartment off gassing with a low gradient at depth which is calculated from the current profile.

After the dive profile has reached a level where a PDI Stop is recommended the MANTIS shows the PDIS symbol and depth on the bottom row.

If no decompression is required, when ascending to a PDI stop depth, the PDIS symbol and depth start blinking on the bottom row for 2 minutes and the PDIS timer counts down on the middle row.

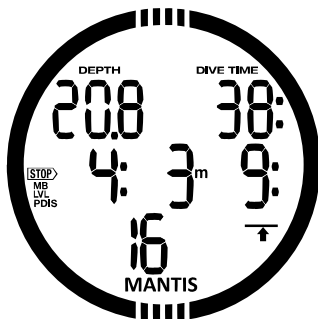

Once the PDIS depth has been reached, you should stay in the zone that is +0.5m.-3.0m / +2ft.-10ft from the shown PDIS depth. If you descend below this zone the PDIS counter is deactivated and MANTIS calculates a new PDIS depth.

If decompression is already required this information remains on the middle row.

In such a case the PDIS counter is not shown, only the PDIS symbol and depth are blinking on the bottom row for the 2 minutes that are recommended for staying in the PDIS zone.

⚠ WARNING

Even when performing a PDI stop, you still MUST perform a safety stop at 5m/15ft for 3 to 5 minutes. Performing a 3 to 5 minute stop at 5m/15ft at the end of any dive is still the best thing you can do for your safety.

4.7.2 No-dive warning after a dive

If MANTIS detects a situation of increased risk (due to the potential microbubble accumulation from previous dives or a CNS O₂ level above 40%), the NO DIVE symbol will appear on the display to advise you against performing another dive right away. The suggested time interval that you should wait prior to diving again is shown on the dive mode display.



You should not perform a dive as long as the no-dive warning is displayed on the computer screen. If the warning is prompted by microbubble accumulation (as opposed to CNS O₂ over 40%) and you dive anyway, you will have shorter no-stop times or longer decompression times. Moreover, the duration of the microbubble warning at the end of the dive can increase considerably.

4.7.3 SOS

If you stay above a depth of 0.8m/3ft for more than 3 minutes without observing a prescribed decompression stop, MANTIS will switch into **SOS** mode. Once in **SOS** mode MANTIS will lock up and will be inoperable as a dive computer for 24 hours. If it is used for diving within the 24hours of an **SOS** lock, it will automatically switch to gauge mode and provide no decompression information.

⚠ WARNING

Violating a mandatory decompression obligation may result in serious injury or fatal issue. Serious injury or fatal issue may result if a diver does not seek immediate treatment should any signs or symptoms of decompression sickness occur after a dive.

Do not dive to treat symptoms of decompression sickness.

Do not dive when the computer is in SOS mode.

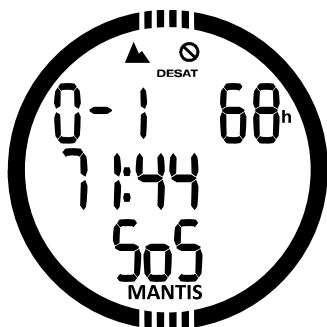

The display shows the same information as when in the presence of desaturation, but on the bottom row SOS is displayed.

4.7.3.1 Desaturation reset

MANTIS allows you to reset the desaturation of the computer. If tissue saturation information from a recent dive is reset to zero, the computer will treat the next dive as a non-repetitive dive. This is useful when the computer is loaned to another diver who has not dived in the last 48 hours.

Chapter **Desaturation reset** describes how to make the desaturation reset.

☞ *NOTE: After a desaturation reset the change between the modes GAUGE, APNEA and SCUBA is possible immediately. However, since the GAUGE and APNEA modes are not tracking your tissue nitrogen loading, it is recommended to keep the initial intervals between changes on modes.*

⚠ WARNING

Diving after having reset the desaturation is extremely dangerous and is very likely to cause serious injury or a fatal issue. Do not reset the desaturation unless you have a valid reason to do so.

☞ *NOTE: Removing and replacing the battery will not reset the desaturation. MANTIS stores tissue saturation information in a non-volatile memory. For the time that the computer is without a battery, the desaturation calculation is frozen, and resumes from where it left off as soon as a new battery is installed.*

4.7.4 Diving with nitrox

Nitrox is the term used to describe breathing gases made of oxygen-nitrogen mixes with the oxygen percentage higher than 21% (air). Because Nitrox contains less nitrogen than air, there is less nitrogen loading on the diver's body at the same depth as compared to breathing air.

However, the increase in oxygen concentration in Nitrox implies an increase in oxygen partial pressure in the breathing mix at the same depth. At higher than atmospheric partial pressures, oxygen

can have toxic effects on the human body. These can be lumped into two categories:

1- Sudden effects due to oxygen partial pressure over 1.4bar. These are not related to the length of the exposure to high oxygen partial pressure. Sudden effects can vary and depend on the exact level of partial pressure they happen at. It is commonly accepted that partial pressures up to 1.4bar are tolerable, and several training agencies advocate maximum oxygen partial pressures up to 1.6 bar.

2- Long exposure effects to oxygen partial pressures over 0.5bar due to repeated and/ or long dives. These can affect the central nervous system, and cause damage to lungs or to other vital organs. Long exposures can be divided to more severe Central Nervous System effects and less dangerous long term Pulmonary Toxicity effects.

MANTIS treats high ppO_2 and long exposure effects in the following ways:

1- Against sudden effects: MANTIS has an MOD alarm set for a user-defined ppO_2 max. As you enter the oxygen concentration for the dive, MANTIS shows you the corresponding MOD for the defined ppO_2 max. The default value of ppO_2 max from the factory is **1.4bar**. This can be adjusted to your preference between **1.0** and **1.6bar**. It can also be turned **OFF**. Please refer to the chapter on Gas **settings** for more information on how to change this setting.

2- Against long exposure effects: MANTIS “tracks” the exposure by means of the CNS O_2 clock. At levels of 100% and higher there is risk of long exposure effects, and consequently MANTIS will activate an alarm when this level of CNS O_2 is reached. MANTIS can also warn you when the CNS O_2 level reaches 75% (see section CNS O_2 = 75%). Note that the CNS O_2 clock is independent of the value of ppO_2 max set by the user.

The CNS O_2 clock increases when the oxygen partial pressure is higher than 0.5bar, and decreases when the oxygen partial pressure is lower than 0.5bar. Hence, while on the surface breathing air you will always be decreasing the CNS O_2 clock. During the dive, the depth at which

0.5bar is reached for various mixes is as follows:

- Air: 13m/43ft
- 32%: 6m/20ft
- 36%: 4m/13ft

 *NOTE: For oxygen concentrations of 80% and higher, the ppO_2 max is fixed at 1.6bar and cannot be changed.*

 *NOTE: Repetitive very long exposures (technical and rebreather diving) with high ppO_2 may cause long term Pulmonary Toxicity effects that can be tracked with OTUs. SCUBAPRO recommends model Galileo TMx for completing such dives.*

4.8 Diving with two or more gas mixtures

MANTIS is equipped with the ZH-L8 ADT MB PMG algorithm. PMG stands for Predictive Multi Gas, meaning that when you program more than one gas mixture, MANTIS will predict the switch to the higher oxygen concentration gas at the depth that you specified and alert you at all times with a decompression schedule comprehensive of all gas mixtures that you programmed. In other words, you get full credit at any point during the dive for all the extra gas mixtures that you are carrying with you. At the same time MANTIS can also show you what the decompression schedule would be if you were to finish the dive using only the gas mixture that you are currently breathing from, so that you can be prepared in the event that something did not work as planned.

WARNING

Diving with multiple gas mixtures represents a much higher risk than diving with a single gas mixture, and mistakes by the diver may lead to serious injury or death.

During dives with multiple gas mixtures, always make sure you are breathing from the tank that you intend to breathe from. Breathing from a high oxygen concentration mix at the wrong depth can kill you.

Mark all your regulators and tanks so that you

cannot confuse them under any circumstance. Before each dive and after changing a tank, ensure that each gas mixture is set to the correct value for the corresponding tank. Get a proper training and certifications to make multi-gas dives prior of making them by yourself.

MANTIS enables you to use up to three gas mixtures during the dive (air and Nitrox only). The three mixtures are labeled 1, 2 and d, and must be in ascending order of the oxygen fraction.

Setting the gas mixture and the depth for changing the gas mixture

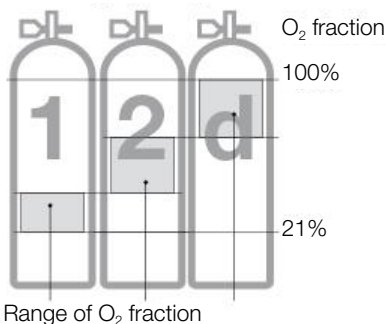

The O₂ concentration of gases can only be set in ascending order as show in the picture above.

O₂ concentration setting shown "--" means that gas is disabled.

MANTIS requires the MODs of gasses to be at least 3m/10ft apart.

Setting the ppO₂max value to OFF applies to Gas 1 only. Gas 2 and d are always limited to a maximum value of ppO₂max of 1.6bar.

For oxygen concentrations of 80% and higher, the ppO₂max is fixed at 1.6 bar and cannot be changed.

The MOD for Gas 2 and d are the switch depths for those gases. This is what MANTIS uses for its calculations, warnings and suggested switch points.

When diving with more than one gas mixture, the Nitrox reset time function (described in the section on Nitrox reset time) has the following effect: Gas1 is set to 21% Gas 2 and d are set to OFF.

NOTE: Start breathing from the tank with the new gas mixture before confirming a switch. Always make sure you are switching to the intended gas. Failure to do so may result in serious injury or death.

4.8.1 Switching gas mixture during the dive

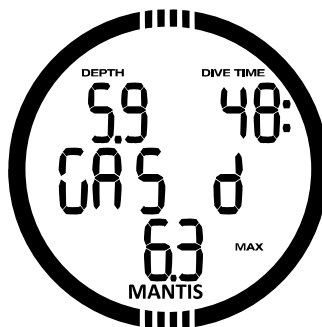

During the ascent phase, when you reach a depth corresponding to the MOD of Gas d, MANTIS will suggest that you perform the switch. An audible sequence goes off, and the text Gas d starts flashing on the display together with the value of the MOD. You have 30 seconds to respond to this message, otherwise MANTIS will consider that Gas d will not be used and adapts the decompression schedule accordingly. To confirm the gas switch, press the SEL button. After you confirm the switch, the text Gas d remains on the screen for five seconds without flashing.

4.8.2 Switching back to a gas mixture with lower oxygen concentration

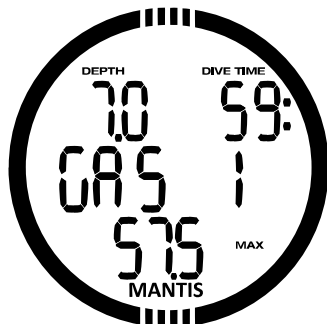

There may be situations in which you have to switch back to Gas 1 or Gas 2 from Gas d. This can happen for instance if you want to descend again below the MOD for Gas d, or if for instance you have run out of Gas d during the decompression. At this point you can manually initiate the gas switch by pressing and holding the SEL/ESC button. MANTIS will display the text Gas 1 and its MOD, flashing. At this point press +/UP to select Gas 2 or press the SEL button to confirm the switch. MANTIS will display the text Gas 1 or Gas 2 for five seconds without flashing and adapt the decompression schedule accordingly.

4.8.3 Gas switch not carried out at the planned depth

If you fail to confirm the gas change within 30 seconds of when MANTIS suggests it, the gas is excluded from the decompression calculation and the decompression schedule is adapted accordingly, basically reflecting the fact that you will finish the dive without using the excluded gas.

NOTE: If, after MANTIS has changed the decompression schedule to reflect the missed gas switch, you descend again below the MOD for Gas d, MANTIS reintroduces Gas d into the calculations and the decompression schedule changes accordingly.

4.8.4 Delayed gas switch

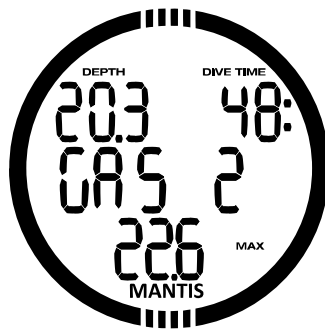

You can catch up on a planned gas mixture switch at any time by selecting the gas manually. Press and hold the SEL/ESC button to start the gas switch procedure. MANTIS will show the text Gas 2 or Gas d and its MOD flashing on the display. This helps you verify that you are performing a switch to a safe gas. At this point press the SEL/ESC button to confirm the switch. MANTIS will display the text Gas d without flashing and adapt the decompression schedule accordingly.

4.8.5 Submerging below the mod after a gas switch

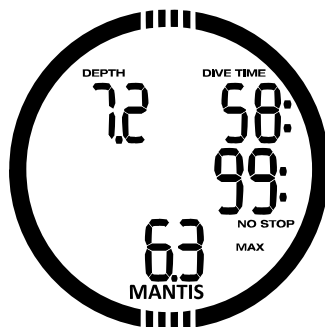

If after having switched to Gas d or Gas 2 you inadvertently drop again below the MOD for that mixture, the MOD alarm will immediately activate. Either switch back to Gas 1, or ascend above the MOD for Gas d or Gas 2.

4.8.6 Diving with CCR mode

The CCR (Closed Circuit Rebreather) system is probably older than the Open Circuit

SCUBA system because the basic operating principle with manual control didn't require a highly reliable regulator system.

CCR also uses the gas more efficiently than open loop, because the oxygen is added to the breathing loop only as much as needed. Respectively the carbon dioxide generated by the body is bound to calc at the scrubber. As a side effect the CCR system is nearly bubble free, which may be beneficial when engaged in photography or observing fishes underwater.

In the CCR system the breathing gas ppO_2 (partial pressure of the Oxygen) is kept constant. The CCR system itself takes care of this. Compared to an Open Loop system the constant ppO_2 converts to a variable nitrox mix at different depths.

For example, a ppO_2 setting of 1.0 bar is comparable to open an loop 50% Nitrox mix at a depth of 10 meters of salt water.

⚠ WARNING

All rebreathers require unit specific education before using them. Get the proper certifications and follow manufacturer recommendations and procedures when diving with a rebreather unit. Deviations may lead to severe injury or death.

4.8.7 Enabling the CCR mode

When the CCR mode is activated, the normally changeable open circuit gases (Gas1, Gas2) are converted to ppO_2 setpoints (SP1, SP2).

The dive start setpoint (SP1) has a selectable range from 0.3 up to 0.95 bar ppO_2 . The bottom setpoint (SP2) has a range from 1.0 up to 1.4 bar ppO_2 and this is switched normally active on the way to the bottom or when the bottom depth is reached.

The SP switch depth is suggested by the dive computer the same way the gas switches are suggested in open circuit mode (predictive gas switching).

The switch points are determined from the equivalent oxygen contents in open circuit mode. So, the SP1 is suggested to be changed on the way down when the equivalent content of the gas at that depth reaches the 21% O_2 level.

For example, with a SP1 of 0.5 bar the depth would be approximately 13.8m in salt water.

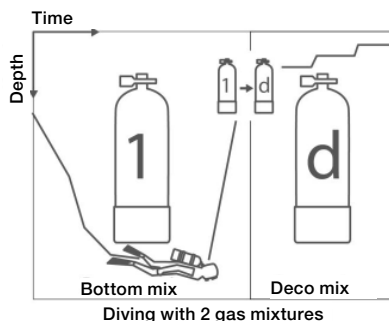

Diving with 2 gas mixtures

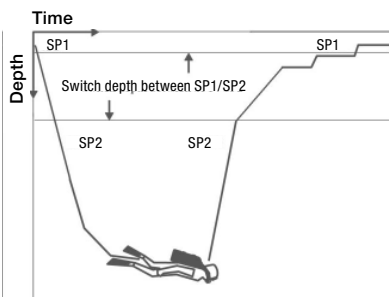

Diving with CCR

4.8.8 Altitude diving

Altitude classes, altitude warning and no-fly time after a dive.

Going to altitude is in a way similar to starting an ascent from a dive: you expose your body to a lower partial pressure of nitrogen and consequently you start offgassing. After a dive, given the higher nitrogen loading in your body, even reaching an otherwise negligible altitude can potentially cause decompression sickness. Consequently, MANTIS constantly monitors the ambient pressure and uses it to evaluate your nitrogen loading and offgassing. If MANTIS notices a drop in ambient pressure not compatible with your current nitrogen loading, it will activate a warning to alert you of the potentially dangerous situation. If you have remaining desaturation on MANTIS, you can view the current situation by selecting the dive menu.

The desaturation text and remaining count down time are shown on the middle row. The no dive symbol and count down timer are shown on the top row to indicate the

period when you should not have another immersion due to possible micro bubbles, high CNS or excessive nitrogen loading in your body.

By pressing the SEL button the following page shows the no-fly symbol, with the count-down time on the top row, until the restriction is completed.

The interval from the last dive is shown on the middle row with the text INT.

Acceptable altitudes are shown at the first page of the planner menu. Prohibited altitudes (the altitudes MANTIS has computed to be incompatible with your current nitrogen saturation levels) are levels above the second altitude on the display. Please read section Altitude and the decompression algorithm for more details.

The current altitude and altitude class can be read on the altitude meter menu:

Reading the Altitude, Barometer and Temperature values.

NOTE: The no-fly, no-dive and altitude restriction symbols are also shown on the time of the day display when applicable.

WARNING

Flying while MANTIS displays the NO FLY symbol can result in serious injury or fatal issue.

4.8.8.1 Altitude and the decompression algorithm

Atmospheric pressure is a function of altitude and weather conditions. This is an important aspect to consider for diving, because the surrounding atmospheric pressure has an influence on on-gassing and off-gassing of nitrogen in your body.

MANTIS divides the possible altitude range into 5 classes that are illustrated in the picture below:

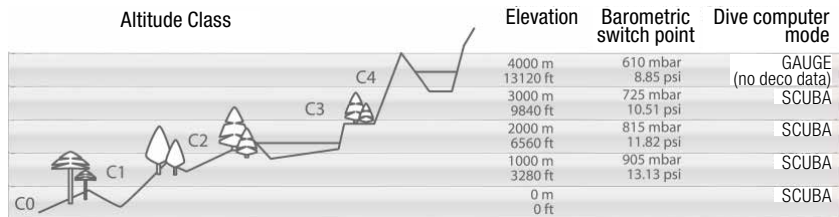

The altitude classes are approximate elevations because the effect of weather conditions can make the switch point pressure occur at different levels.

WARNING

At altitude class 4 MANTIS functions in gauge mode only (automatic switch from computer mode).

NOTE: You can check your current altitude class and elevation by activating the altitude meter. Refer to chapter **Reading the Altitude, Barometer and Temperature values** on how to do so.

NOTE: MANTIS deals with altitude automatically: it monitors the atmospheric pressure every 60 seconds and if it detects a sufficient drop in pressure, it does the following: it indicates the new altitude range and, if applicable, the prohibited altitude range; it indicates the desaturation time, which in this case is an adaptation time to the new ambient pressure. If a dive is started during this adaptation time, MANTIS considers it a repetitive dive, since the body has residual nitrogen.

☞ **NOTE:** A fast descent from mountains or a fast rise in airplane cabin pressure may activate the dive mode. The MANTIS will automatically detect and end this “dive” after 12 hours or you may manually activate the check by press and hold both +/UP and -/DOWN buttons at the same time. This kind of false dive will not be stored in the MANTIS logbook.

4.8.8.2 Prohibited altitude

Going to altitude, as well as flying after diving, exposes your body to a reduced ambient pressure. Similar, in a way, to the no-fly time, MANTIS advises you which altitude classes are safe to reach after a dive and which aren't. If you have to drive over a mountain pass to return home after a dive, you can view this information in the planner menu.

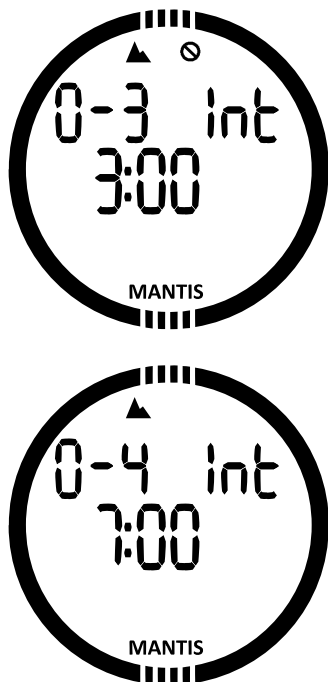

The current altitude class is shown on the left top row and the prohibited altitude is shown on the right. In the top example above, the diver

is presently at altitude class 0 and should not reach altitudes above 3000m (class 3) within given interval of 3 hours and 0 minutes.

By increasing the interval time on the middle row the allowed altitude increases due to the desaturation caused by the time spent at the current altitude class (as shown on the lower example).

☞ **NOTE:** when the no repetitive dive symbol is on, the planner on the middle row initially shows the time period when diving would be allowed again. For planning the altitude excursion the interval time can be reduced, which causes the prohibited altitude level to decrease.

MANTIS has an altitude warning: if you were to reach an altitude that, according to MANTIS is incompatible with your current residual nitrogen levels, it will warn you with an altitude warning.

4.8.8.3 Decompression dives in mountain lakes

In order to assure optimal decompression even at higher altitudes, the 3m/10ft decompression stage is divided into a 2m/7ft stage and a 4m/13ft stage in altitude ranges 1, 2 and 3.

If atmospheric pressure is below 610mbar (altitude higher than 4000m/13300ft), no decompression calculation is carried out by MANTIS (automatic GAUGE mode). In addition, the dive planner is not available in this altitude class.

4.8.9 Warnings and alarms

MANTIS can alert you of potentially dangerous situations via warnings and alarms. **You can only modify the warning and alarm settings via PC interface.**

Warnings represent situations that require the diver's attention, but ignoring them does not represent an immediate risk. It is up to you to decide which ones you would like to be active and which ones not. The available warnings are:

4.8.9.1 CNS O₂ = 75%

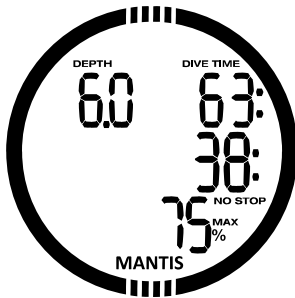

MANTIS tracks your oxygen uptake via the CNS O₂ clock. If the calculated value of CNS O₂ reaches 75%, MANTIS will emit a sequence of audible beeps for 12 seconds and the % symbol will be blinking in the bottom right corner. The blinking will continue until the value of CNS O₂ drops under 75%.

4.8.9.2 No-Stop time = 2 minutes

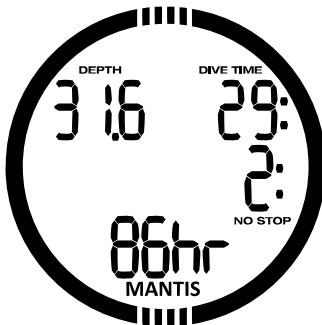

If you wish to avoid unintentionally performing a decompression dive, MANTIS can activate a warning when the no-stop time reaches 2 minutes. This applies to current selected MB level no-stop time (see chapter Diving with MB levels for more information on MB level diving). It gives you the opportunity to start ascending before incurring a decompression stop or a level stop obligation.

MANTIS emits a sequence of audible beeps for 12 seconds and the no-stop time will blink. The blinking will continue until you ascend sufficiently for the no-stop time

to increase to 6 minutes, or until MANTIS enters into decompression.

4.8.9.3 Entering decompression



MANTIS can activate a warning when the first mandatory decompression stop appears. This alerts the diver to the fact that a direct ascent to the surface is no longer possible.

When the no-stop time ends and a mandatory stop is required before reaching the surface, MANTIS emits a sequence of audible beeps and the DECO STOP symbol blinks, both for 12 seconds.

4.8.9.4 MB LEVEL ignored

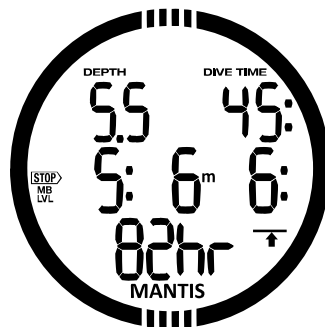

When you have set MB level higher than L0 and you reach a depth shallower than the deepest required MB level stop, this warning will be activated. MANTIS emits a sequence of audible beeps and the MB level stop symbol, MB level depth and MB level time will blink for 12 seconds.

Alarms can not be turned off because they represent situations that do require

immediate action by the diver. Alarms are described in the following chapters.

⚠ WARNING

- When in GAUGE mode, all warnings and all alarms are OFF except for the low battery alarm.
- When MANTIS is set to SOUND OFF mode, all audible alarms and warnings are switched off.

4.8.9.5 Ascent rate

As you ascend during a dive, the pressure surrounding you diminishes. If you ascend too quickly, the resulting pressure reduction could lead to microbubble formation. If you ascend too slowly, the continued exposure to high ambient pressure means you will continue loading some or all of your tissues with nitrogen. Consequently, there is an ideal ascent rate that is slow enough to minimize microbubble formation yet fast enough to minimize the effect of continued loading on your tissues.

The pressure reduction that the body can tolerate without significant microbubble formation is higher at depth than it is in shallow water: The key factor is not the pressure drop itself, but rather the ratio of the pressure drop relative to the ambient pressure. This means that the ideal ascent rate at depth is higher than it is in shallow water.

DEPTH		ASC SPEED	
m	ft	m/min	ft/min
0	0	7	23
6	20	8	26
12	40	9	29
18	60	10	33
23	75	11	36
27	88	13	43
31	101	15	49
35	115	17	56
39	128	18	59
44	144	19	62
50	164	20	66

If the ascent rate is greater than 110% of the ideal value the **SLOW** symbol appears.

For ascent rates higher than 140%, the **SLOW** symbol starts blinking.

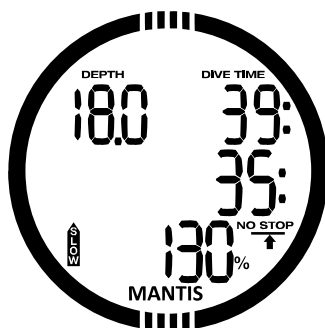

MANTIS also provides an audible alarm in case ascent rates exceed 110%: the intensity of the alarm increases in direct proportion to the degree that the ideal ascent rate is exceeded.

In case of a fast ascent, MANTIS may require a decompression stop even within the no-stop phase because of the danger of microbubble formation.

From great depth a slow ascent may cause heightened saturation of tissues and an extension of both decompression duration and total ascent time. At shallow depth, a slow ascent may shorten the decompression duration.

Excessive ascent rates for longer periods are entered in the logbook.

⚠ WARNING

The ideal ascent rate must not be exceeded at any time since this could lead to microbubbles in the arterial circulation which could cause serious injury or fatal issue.

The alarm persists for as long as the ascent rate is 110% or more of the ideal ascent rate.

4.8.9.6 MOD/ppO₂

⚠ WARNING

- The MOD should not be exceeded. Disregarding the alarm can lead to oxygen poisoning.
- Exceeding a ppO₂ of 1.6bar can lead to sudden convulsions resulting in serious injury or fatal issue

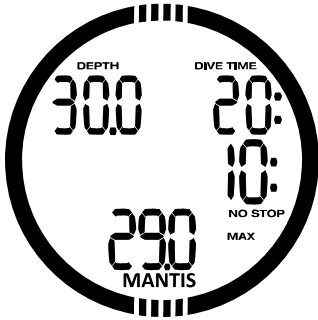

If you exceed the MOD, in the bottom row the blinking MOD value is displayed with MAX symbol so you can see by how much you have exceeded it. In addition, MANTIS will beep continuously. Both the blinking of the MOD value and the beeping will continue for as long as you stay deeper than the MOD.

4.8.9.7 CNS O₂ = 100%

⚠ WARNING

When the CNS O₂ reaches 100% there is danger of oxygen toxicity. Start procedure to terminate the dive.

MANTIS tracks your oxygen uptake via the CNS O₂ clock. If the calculated value of CNS O₂ reaches 100%, MANTIS will emit a sequence of audible beeps for 12 seconds and the symbol O₂% MAX will be blinking in the bottom right corner. The blinking will continue until the value of CNS O₂ drops under 100%.

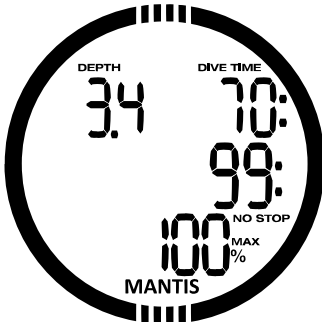

The audible signal stays on for as long as the CNS O₂ value equals or exceeds 100%;

or until you reach a depth where the ppO₂ is less than 0.5bar.

4.8.9.8 Missed decompression stop

⚠ WARNING

Violating a mandatory decompression obligation may result in serious injury or fatal issue.

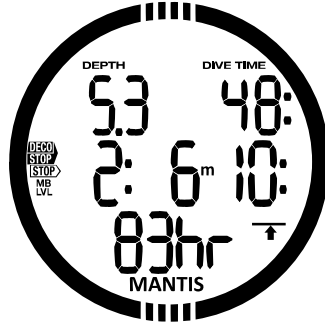

If in the presence of a required decompression stop you ascend more than 0.5m/2ft above the required stop, MANTIS will trigger an alarm: the value of the current depth and the value of the required stop depth will blink, and a sequence of beeps will be heard. This will continue for as long as you stay 0.5m/2ft or more above the required stop.

4.8.9.9 High workload

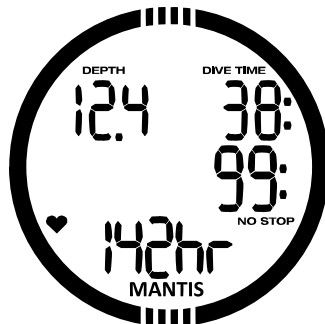

If MANTIS detects a sufficient increase in workload, no-stop times may shorten and decompression stops can increase. MANTIS warns you of this situation with an audible beeps and shows the heart symbol.

 **NOTE:** MANTIS analyzes your heart rate pattern over time to determine workload and hence algorithm adaptation. The heart rate shown on the display is not indicative of the workload itself.

Near a decompression stop MANTIS does not consider the effect of workload but instead utilizes the slowest possible perfusion for each compartment.

4.8.9.10 MB LEVEL reduced

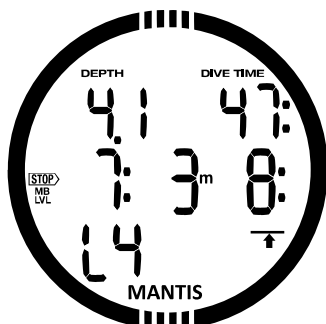

When you have set a MB level higher than L0 and you ascend more than 1.5m above the required MB level stop, or after ignoring the MB level warning you stay at a shallower depth, MANTIS will reduce your MB level to the next possible level. The audible alarm will be active for 12 seconds and the new MB level will blink on the bottom row until the end of the dive.

4.8.9.11 Low battery

WARNING

Do not start a dive if the battery symbol is blinking. The computer may fail to function during the dive and this could lead to serious injury or fatal issue.

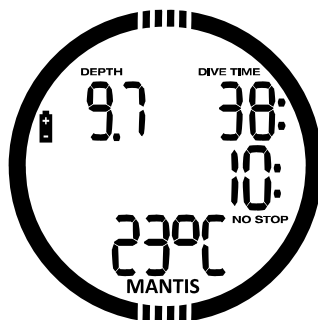

During the dive, MANTIS alerts you of precarious battery situations in two ways: By displaying a steady battery symbol on the screen. This means you can finish the dive but you should replace the battery once you return to the surface; By displaying a blinking battery symbol on the screen. This means you need to start the procedure to terminate the dive, as there is not enough energy in the battery to ensure proper continued functioning and the computer may fail. If the battery symbol is blinking, the backlight cannot be activated and the audible warnings and alarms are not available anymore.

4.9 GAUGE mode

When MANTIS is set to GAUGE mode, it will only monitor depth, time, and temperature, and will not carry out any decompression calculations. You can only switch to GAUGE mode if the computer is completely desaturated. Audible and visual warnings and alarms, except depth and dive time cannot be activated.

 **NOTE:** The low battery alarm is also active in GAUGE mode.

WARNING

Dives in gauge mode are performed at your own risk. After a dive in gauge mode you must wait at least 48 hours before diving using a decompression computer.

MANTIS will show neither the remaining desaturation time nor the CNS O₂% value

on the surface in gauge mode. It will however display a surface interval up to 48 hours and a 48 hour no-fly time. This no-fly time is also the time during which you cannot switch back to computer mode.



During a dive in GAUGE mode, MANTIS displays a stopwatch in the middle row. The stopwatch can be stopped by pressing the -/DOWN button. When the stopwatch is stopped, it can be reset and restarted by press and hold of the -/DOWN button. While in GAUGE mode, the average depth can be reset. To reset the average depth, press and hold the +/UP button. As in SCUBA mode, press the +/UP button to view the time of day or other alternate information on the bottom row. For example, in the display below the heart rate has been selected (78hr).



Alternate info can be selected by pressing +/UP button in the following order:
 Max depth (after 1m/3feet ascent detected)
 Average depth
 Temperature
 Heart rate (hr)

Skin temperature (if SCUBAPRO belt is used)
 Current time of the day.

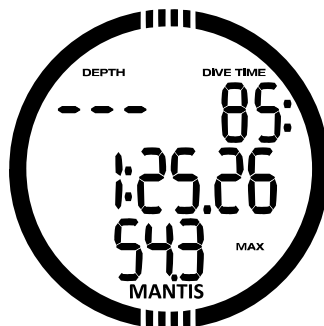

After a dive, the gauge mode surface display shows the dive time on the top row. On the middle row the stopwatch is running from the dive start or last manual restart. On the bottom row the maximum depth of the dive is shown. After a 5 minute timeout the display changes to the GAUGE mode menu.

4.10 APNEA mode

MANTIS has an advanced APNEA diving mode. The main features include faster a sampling rate than in normal SCUBA mode and alarm functions tailored to APNEA diving.

MANTIS measures the depth in APNEA mode every 0.25 seconds to ensure the precise maximum depth. In the logbook the data is saved in 1 second intervals. The increased amount of data being saved requires more storage space; therefore you can store approximately 10 hours of log data in APNEA mode.

In APNEA mode it is also possible to start and stop the dive manually by a press and hold of the -/DOWN button. This way you can use MANTIS for static APNEA dives, where normal dive start depth of 0.8 meters will not start a new dive.

NOTE: An APNEA dive is stored in the logbook only when there is at least one immersion in the session with a logged depth greater than 0.8m.

As with gauge mode, MANTIS doesn't carry out any decompression calculation. You can only switch to APNEA mode if the computer is completely desaturated.

The alternate info is shown on the bottom row and can be selected by pressing +/UP in the following order:

Heart rate.

Temperature.

Skin temperature (if SCUBAPRO belt is used).

Sequential dive number done at this APNEA session.

 **NOTE:** The ascent/descent speed is shown as a pop up when 0.1m/sec is exceeded in the alternate info field.

The dive depth is shown on the top row with dive time on the middle row which is shown in minutes and seconds (after 20 minutes in full minutes only).

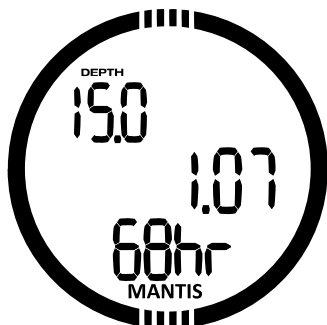

On the middle row, the surface interval counter counts to 15 minutes. If no repetitive dive is done, MANTIS reverts to the APNEA menu display.

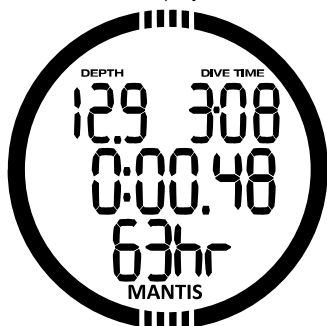

When SIF is enabled the no dive symbol will be shown at the surface until this period has elapsed. An audible signal is given after this. When total session depth is enabled and the limit is reached the blinking no dive symbol is shown and an audible signal is given.



4.11 SWIM mode

It is sometimes practical to be able to measure a distance at the surface; for example when searching the dive site.

If your MANTIS has the Surface Exercise mode enabled, you can count your swimming stroke or kick cycles and measure the distance covered during the exercise. Naturally, when kick counting MANTIS must be fixed to your ankle.

MANTIS can be set to SWIM mode from any of the surface displays (SCUBA, GAUGE, APNEA) by a press and hold of the +/UP button.

 **NOTE:** The SWIM mode operates only on the surface. It will switch automatically to active dive mode when immersed deeper than 3m/10ft.

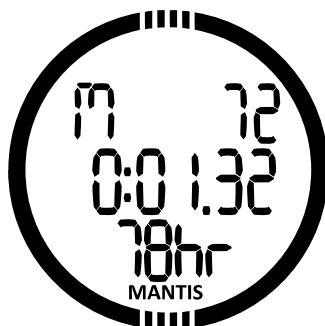

In SWIM mode and during surface exercise, MANTIS displays the count of strokes or heart rate on the bottom row, the elapsed time on the middle row and the converted total distance on the top row

5. MANTIS ASSESORIES

5.1 HR belt

MANTIS receives the signal of various low frequency heart rate belts.

The new SCUBAPRO heart rate belt features a patented skin temperature measurement and transmission that is supported by the MANTIS.

HR belt positioning is shown below. Adjust the strap so that it is comfortable to wear but stays in place. When wearing a diving suit the HR belt must be directly against the skin. Moisten the electrode areas if your skin is dry or when wearing a dry suit.

NOTE: The front side of the temperature HR belt should be against the suit and not covered by body parts.

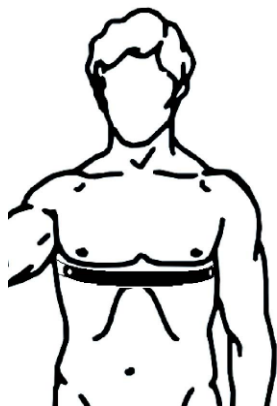

You must enable the heart rate setting on your MANTIS, refer to the section on **Heart rate limits** and **Skin temperature** to learn how to do this.

After a dive rinse the heart rate belt in fresh water, dry it and store in a dry place.

We recommend having the battery changed by an authorized SCUBAPRO dealer for HR belts with a battery cap. With

completely sealed HR belts the battery cannot be changed.

Check the operation conditions and depth rating of the HR belt from the unit or its package.

5.2 Nylon arm strap

Divers wearing a thick neoprene wetsuit or drysuit may prefer a longer arm strap. MANTIS can be equipped with a one piece 31 cm/12inch Scubapro nylon arm strap.



NOTE: The MANTIS arm strap is attached with Solid Stainless Steel pins that are splintered on one end. Always push the pins out with the splintered end first. In the housing the splintered side can be recognized from the slightly larger diameter guiding at the hole. The disassembly and assembly of the arm strap requires a special tool. We recommend the arm strap change be done by authorized SCUBAPRO dealer.



5.3 Battery compartment o-ring

Each time the MANTIS battery compartment is opened a new SCUBAPRO O-ring must be used. MANTIS battery compartment O-rings are available from your authorized SCUBAPRO UWATEC dealer.



5.4 Display guard

You can protect your MANTIS glass face with a SCUBAPRO display guard. This foil can be easily replaced if damaged.



6. MANTIS PC INTERFACE

6.1 Cradle - accessory

Communication between MANTIS and a PC/Mac is possible only with a cradle. A cradle can be bought from your Authorized SCUBAPRO dealer:



The communication between the MANTIS and the cradle is established via contacts to the case. Therefore, if the water contact or the spring contact on the cradle have surface dirt, this should be cleaned with a piece of cloth before use

To avoid scratching your MANTIS, first place the contacts together and then click your MANTIS into the cradle.

6.2 Introduction to Scubapro LogTRAK

LogTRAK is the software that allows MANTIS to communicate with a Windows-based PC or Mac OS.

In order to take advantage of any of these features, you need to establish a communication between your PC and MANTIS with a cradle.

To start the communication

1. Connect the cradle to your PC
2. Launch LogTRAK on your PC
3. Select the serial port where the cradle is connected

Extras -> Options -> download



Select the COM port that is used for MANTIS cradle.

4. Place the MANTIS on the cradle.

Download dive profiles

From LogTRAK, by selecting Dive -> Download Dives you can transfer the MANTIS Logbook to your PC or Mac.

There are three main views each showing a specific part of your dive logs:

Profile shows the graphical data of the dive.

Details about the dive, where you can edit, for example, the equipment and tank information.

Location, shows your dive site on the world map.

The selection tabs for views are on the left side of the main window.

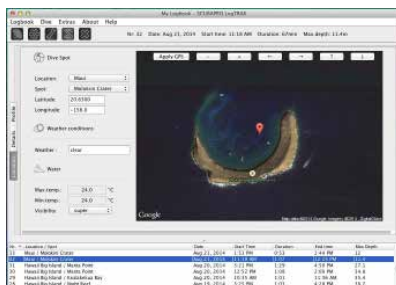
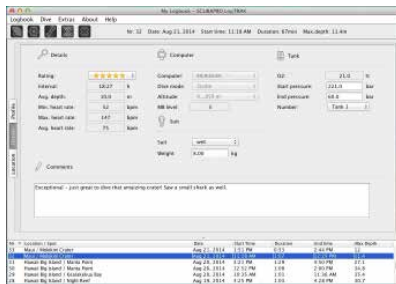

6.3 Change warnings/ settings of the mantis and reading the computer information

By selecting Extras -> Read Dive Computer settings you can enable/disable warnings that cannot be enabled or disabled by using the menus on the MANTIS unit.

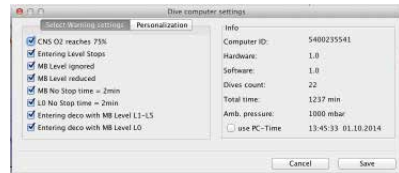

Read the chapter Warnings and alarms about the possible selections that you can modify on your MANTIS.

You may also change the shown units between metric/imperial. Select Extras -> Options -> measurement units:

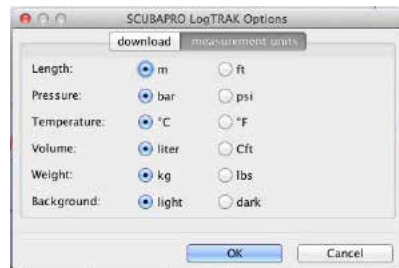

7. TAKING CARE OF MANTIS

7.1 Technical information

Operating altitude:

- with decompression - sea level to approximately 4000m/13300ft
- without decompression (gauge mode) - at any altitude.

Max operating depth:

- 120m/394ft; resolution is 0.1m until 99.9m and 1m at depth deeper than 100m.
- Resolution in ft is always 1ft. Accuracy is within 2% ±0.2m/1ft.

Decompression calculation range:

- 0.8m to 120m / 3ft to 394ft

Clock:

- quartz clock, time, date, dive time display up to 999 minutes

Oxygen concentration:
adjustable between 21% and 100%

Operating temperature:
-10C to +50C / 14F to 122F

Power supply:
CR2032 lithium battery

Life of the battery:
Estimated 2 years or 300 dives, whichever comes first. Actual battery life depends on the number of dives per year, the length of each dive, the water temperature and the usage of the backlight.

7.2 Maintenance

The depth accuracy should be verified every two year and can be done by an authorized SCUBAPRO dealer. Aside from that, MANTIS is virtually maintenance free. All you need to do is rinse it carefully with fresh water after each dive and change the battery when needed. To avoid possible problems with your MANTIS, the following recommendations will help assure years of trouble free service:

- avoid dropping or jarring your MANTIS
 - do not expose MANTIS to intense, direct sunlight
 - do not store MANTIS in a sealed container, always ensure free ventilation.
- If there are problems with the water contact, use soapy water to clean MANTIS and dry it thoroughly. Do not use silicone grease on the water contacts!
- Do not clean MANTIS with liquids containing solvents.
 - Check the battery capacity before each dive.
 - If the battery warning appears, replace the battery.
 - If any error message appears on the display, take MANTIS back to an authorized SCUBAPRO dealer.

7.3 Replacing the battery in MANTIS

The main battery change must be made with particular care in order to prevent water from seeping in. The warranty does not cover damages due to an improper placement of the battery.

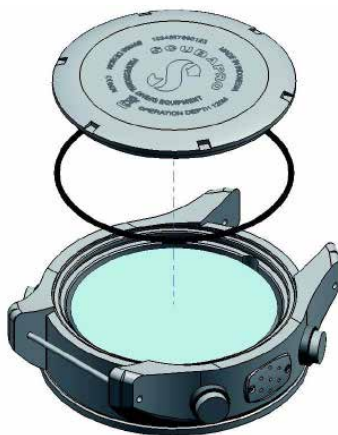

⚠ WARNING

- A leaking battery cap may lead to the destruction of MANTIS by water seeping in or cause MANTIS to switch off without prior notice.
- Always open the battery compartment in a dry and clean environment.

Dry MANTIS with a soft towel.
Unscrew the battery cap with a tool.
Replace the main O-ring (replacement O-rings are available from your authorized SCUBAPRO UWATEC dealer).
Remove the isolation sticker.
Open the battery latch with tweezers.
Remove the empty battery and recycle it in environmentally friendly way.
Insert the new battery with "+" side on top.
Close the battery latch.
Attach the isolation sticker.
Screw the battery cap back in place.
Check the MANTIS functions and housing sealing.

⚠ WARNING

We recommend having the MANTIS battery replaced by an Authorized SCUBAPRO dealer. The change must be made with particular care in order to prevent water from seeping in. The warranty does not cover damages due to an improper placement of the battery or incorrect closing of the battery cap.

MANTIS stores the tissue saturation information in a non-volatile memory, so the battery can be replaced at any time between dives without loss of information.

 **NOTE:** *After a dive, while on the surface, MANTIS stores tissue desaturation data once every hour until desaturation is complete. If a battery is changed while MANTIS has remaining desaturation time, the tissue data will not be lost, but MANTIS will reference the last stored data set. As a consequence, the data displayed on the surface screen after the battery change (desaturation time, surface interval, no-fly time and CNS O₂) may be different from the values displayed just prior to battery removal.*

After replacing the battery, you must set the date and time.

The O-ring must be replaced each time the MANTIS is opened.

The battery case must be completely closed.

7.4 Warranty

MANTIS has a two-year warranty covering defects in workmanship and functioning. The warranty only covers dive computers, which have been bought from an authorized SCUBAPRO dealer. Repairs or replacements during the warranty period do not extend the warranty period itself.

Excluded from warranty coverage are faults or defects due to:

- excessive wear and tear
- exterior influences, e.g. transport damage, damage due to bumping and hitting, influences of weather or other natural phenomena
- servicing, repairs or the opening of the dive computer by anybody not authorized to do so by the manufacturer
- pressure tests which do not take place in water
- diving accidents
- improper placement of the battery cap.

For European Union markets, the warranty of this product is governed by European legislation in force in each EU member state. All warranty claims must be returned with dated proof-of-purchase to an Authorized SCUBAPRO Dealer. Visit www.scubapro.com for the dealer nearest you.



Your dive instrument is manufactured with high-quality components that can be recycled and reused.

Nevertheless these components, if not properly managed in accordance with the regulations on waste electrical and electronic equipment, are likely to cause harm to the environment and/or to human health.

Customers living in the European Union can contribute to protecting the environment and health by returning old products to an appropriate collection point in their neighbourhood in accordance with EU Directive 2012/19/UE.

Collection points are in particular provided by some distributors of the products and local authorities.

Products marked with the recycling symbol on the left must not be disposed of in normal household waste.

8. GLOSSARY

AVG:	Average depth, calculated from the beginning of the dive or from the time of reset.
CCR:	Closed Circuit Rebreather.
CNS O ₂ :	Central Nervous System oxygen toxicity.
DESAT:	Desaturation time. The time needed for the body to completely eliminate any nitrogen taken up during diving.
Dive time:	The time spent below a depth of 0.8m/3ft.
Gas:	Refers to the main gas that is set for the ZH-L8 ADT MB algorithm.
Local time:	The time in the local time zone.
Max depth:	Maximum depth reached during the dive.
MB:	Microbubble. Microbubbles are tiny bubbles that can build up in a diver's body during and after a dive.
MB level:	One of the six steps, or levels, in SCUBAPRO's customizable algorithm.
MOD:	Maximum Operating Depth. This is the depth at which the partial pressure of oxygen (ppO ₂) reaches the maximum allowed level (ppO ₂ max). Diving deeper than the MOD will expose the diver to unsafe ppO ₂ levels.
Multi gas:	Refers to a dive in which more than one breathing gas is used (air and/or Nitrox).
Nitrox:	A breathing mix made of oxygen and nitrogen, with the oxygen concentration being 22% or higher. In this manual, air is considered as a particular type of Nitrox.
NO FLY:	Minimum amount of time the diver should wait before taking a plane.
No-stop time:	This is the time that a diver can stay at the current depth and still make a direct ascent to the surface without having to perform decompression stops.
O ₂ :	Oxygen.
%O ₂ :	Oxygen concentration used by the dive computer in all calculations.
PDIS:	Profile Dependent Intermediate Stop is an additional deep stop which is suggested by MANTIS at depth where 3rd or 4th compartment starts off gassing.
ppO ₂ :	Partial pressure of oxygen. This is the pressure of the oxygen in the breathing mix. It is a function of depth and oxygen concentration. A ppO ₂ higher than 1.6bar is considered dangerous.
ppO ₂ max:	The maximum allowed value for ppO ₂ . Together with the oxygen concentration it defines the MOD.
Press:	The act of pressing and releasing one of the buttons.
Press and hold:	The act of pressing and holding one of the buttons for 1 second before releasing it.
INT.:	Surface interval. Elapsed time since your last dive has ended.
SOS mode:	The result of having completed a dive without respecting all mandatory decompression obligations.
Stopwatch:	A stopwatch. To time certain steps of the dive.
UTC:	Universal Time Coordinated, refers to time zone changes when traveling.

9. INDEX

Active backlight	8, 11, 33, 35
All-silent mode	10
Altimeter	7, 14
Ascent rate	45
Backlight	8, 11, 33, 35
Battery	5, 11, 47, 50,
Bookmarks	33, 35
Buttons	7, 33
CCR	25, 40, 41, 24
Clock settings	8
CNS O ₂	37, 44, 46, 55
Date	8, 10
Desaturation	46
Desaturation reset	26, 37
Dive planner	15
Diving at altitude	41
Flying after diving	42
Gauge mode	47
Logbook	17, 5, 52
Maintenance	53
MB levels	35, 55
Microbubbles	35, 55
MOD	24, 45, 55
Mountain lakes	43
No-dive warning	36
Nitrox	25, 37, 55
Nitrox reset	25
No-fly time	22, 42, 55
Oxygen concentration	37
Oxygen partial pressure	37
PC interface	51
ppO ₂ max	55
Safety stop timer	35
Log TRAK	52
SOS mode	37, 55
Stopwatch	13
Surface interval	22, 29, 30, 55
Technical information	52
Time of day	7, 12
Time zone	55
Units	27
UTC	9, 55
Warning clock	7
Wake-up warning	7
Warnings	43, 52
Water contact	51, 53
Water type	28