

# Operating Manual

Deutsch

English

Français



## Smart PRO Smart COM

## Safety considerations

You must carefully read and understand this entire manual before using your new computer.



Diving has many inherent risks. Even if you follow the instructions of this manual in a careful manner, it is still possible that you may be seriously injured or die from decompression sickness, oxygen toxicity or some other inherent risk of scuba with Nitrox or compressed air. Unless you are fully aware of these risks and are willing to personally accept and assume responsibility for those risks, do not use the computer!

### Guidelines for the use of your UWATEC dive computer:

The following guidelines are derived from the latest medical research and the recommendations of the American Academy of Underwater Sciences for diving with diving computers. Following these guidelines will greatly increase your safety while diving, but cannot guarantee that decompression sickness or oxygen toxicity will not occur.

- This computer is designed for dives with Nitrox (to a max. 100% O<sub>2</sub>) and compressed air (21% O<sub>2</sub>) only. Do not use the computer for dives made with other mixed gases.
- It is absolutely necessary to check the set mixture before each dive and to compare it to the gas mixture currently used. Always remember: setting an incorrect mixture carries an inherent risk of decompression sickness and/or oxygen toxicity! Maximum deviation from the measured mixture must not exceed 1% O<sub>2</sub>. An incorrect gas mixture can be lethal!
- Only use this computer with open circuit breathing systems. The computer must be set for a determined gas mixture.
- Only use this computer for diving with an independent breathing apparatus. The computer is not designed for long term exposures with Nitrox.
- Always observe the visual and audible alarm signals of the computer. Avoid situations of increased risk which are marked with a warning sign in this operating manual.
- If the ascent arrow appears, start to ascend. ▲
- If the flashing ascent arrow appears, start to ascend immediately. ▲
- This computer has a ppO<sub>2</sub> warning, the default limits of which are set at 1.4 bar ppO<sub>2</sub>max. This limit can be adjusted via SmartTRAK. An alteration of the ppO<sub>2</sub>max to higher than 1.6 bar is dangerous and we do not recommend this.
- Frequently check the "oxygen clock" (CNS O<sub>2</sub>), especially in the range higher than 1.4 bar ppO<sub>2</sub>. Ascend and finish the dive if the CNS O<sub>2</sub> exceeds 75%.
- Never dive deeper than the Maximum Operating Depth (MOD) pertinent to the gas mixture in use.
- Always check the diving limits considering the oxygen content and standard sports diving procedures (decompression sickness, oxygen toxicity).
- In accordance with the recommended maximum diving limit of all instructional agencies, do not dive deeper than 40 metres/130 feet.
- The danger of nitrogen narcosis has to be taken into consideration. The computer gives no warning about this.
- On all dives, with or without dive computer, make a safety stop for at least 3 minutes at 5 metres (15 feet).
- All divers using dive computers to plan dives and indicate or determine decompression status must use their own computer, which they take with them on all dives.
- If the computer fails at any time during the dive, the dive must be terminated, and appropriate surfacing procedures (including a slow ascent and a 3 to 5 minute safety stop at 5 metres /15 ft) should be initiated immediately.
- Comply with the ascent rate and carry out any decompression stop required. If the computer should fail for any reason, you must ascend at a rate of 10m (30 feet) per minute or less.
- On any given dive, both divers in a buddy pair must follow the most conservative dive computer for that particular dive.
- Never dive without a buddy. The computer does not substitute for a dive buddy.
- Only make dives that are appropriate to your level of dive training. A dive computer does not increase your knowledge of diving.
- Always dive with back-up instruments. Make sure that you always use back-up instrumentation including a depth gauge, submersible pressure gauge, digital bottom timer or dive watch, and have access to decompression tables whenever diving with a dive computer.

- Avoid repeated ascents and descents (yo yo diving).
- Avoid repeated heavy workload while at depth.
- Plan the dives to be shorter if they are made in cold water.
- After finishing the decompression or at the end of a no-stop dive, the final stage of the ascent should be as slow as possible.
- You MUST be familiar with all signs and symptoms of decompression sickness before using this computer! Seek IMMEDIATE treatment for decompression sickness should any of these signs or symptoms occur after a dive! There is a direct correlation between the effectiveness of treatment and the delay between the onset of symptoms and the treatment for decompression sickness.
- Only dive with Nitrox after you have been thoroughly instructed by a recognised institution.

### Repetitive dives

- Do not start your next dive before your CNS O<sub>2</sub>% status has dropped below 40%.
- Diving with Nitrox: make sure your surface interval is long enough (just like diving with compressed air). Plan for a minimum surface interval of two hours. Oxygen, too, needs sufficient time to leave the body.
- Match gas mixture to the intended dive.
- Do not attempt a repetitive dive if the microbubble warning  is visible on the display.
- Plan a day without diving once a week.
- If you have to change computers, wait at least 48 hours before carrying out your next dive.

### Altitude and diving

- Do not dive at altitudes higher than 4000 m (13000 ft).
- After a dive do not rise to altitudes that the computer prohibits via the flashing altitude segments (see page 21).



### Flying after diving

- After diving, wait at least 24 hours prior to flying.



The Smart PRO and Smart COM dive instruments are personal protective equipment in compliance with the essential safety requirements of the European Union directive 89/686/EEC. RINA SpA, Via Corsica 12, I-16128 Genoa, notified body no. 0474, have certified their conformity with the European Standard EN 13319:2000 and, limited to Smart COM with the European Standard EN 250:2000.

EN250:2000 Respiratory equipment - Open-circuit self contained compressed air diving apparatus - Requirements, testing, marking (pressure gauge test).

EN13319:2000 Diving accessories - Depth gauges and combined depth and time measuring devices - Functional and safety requirements, test methods. Any information on decompression obligation displayed by equipment covered by this standard is explicitly excluded from its scope.

## Introduction

Congratulations on purchasing a Smart PRO or Smart COM dive computer and welcome to UWATEC. From now on you will enjoy the assistance of the most extraordinary dive computer - equipped with UWATEC's most innovative technology - while diving.

This operating manual provides full information on the operation and functions of UWATEC Smart PRO and Smart COM dive computers. To make this manual easier to read we will use the term „Smart“ as an abbreviation for „UWATEC Smart PRO diving computer“ and „UWATEC Smart COM diving computer“ throughout this booklet. Information which is valid only for Smart COM is marked with „COM“.

We thank you for choosing Smart and we hope you will enjoy safe dives in the future! Further information on UWATEC Smart dive computers and other products by UWATEC can be found on our web page at [www.uwatec.com](http://www.uwatec.com).

### Safety considerations

*Dive computers provide divers with data; they, however, do not provide the knowledge how this data should be understood and applied. Dive computers cannot replace common sense! You must therefore carefully read and understand this entire manual before using your Smart.*

## Important remarks concerning signal words and symbols

This operating manual makes use of the following icons to indicate especially important comments:

### Remarks



Information and tips which are important for optimal use of the functions of Smart.

### Danger!



Indicates a potentially hazardous situation which, if not avoided, could result in death or serious injury.

## The following symbols are used in the operating manual:



Flashing display

-> Page reference  
e.g. ->10

COM Information valid only for Smart COM

## Audible signals

») 4 sec ») Audible attention signal



Audible alarm signal

## Instructions for manual input



Operating instruction for manual input  
Example: bridging contacts B and E

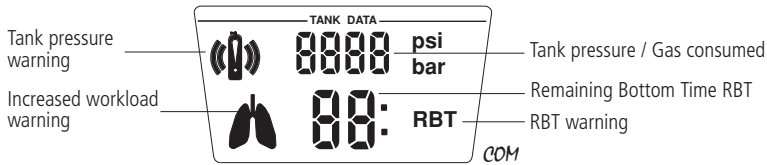
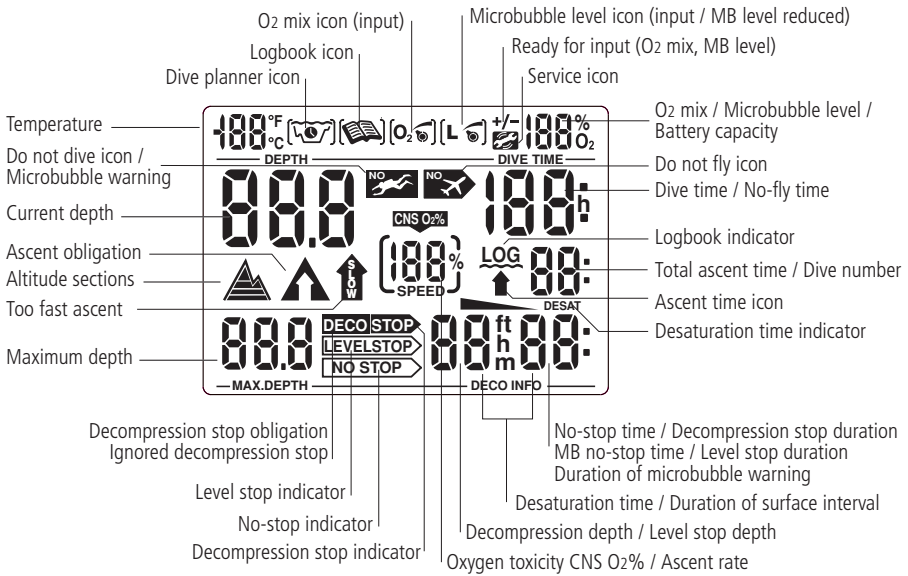

Operating scheme

- Start / Enter
- + / Navigate
- / Navigate

- Display switches off automatically after 3 minutes without operation.
- The backlight can be switched on by pressing Smart PRO above the display, and Smart COM at the right hand side of the display.

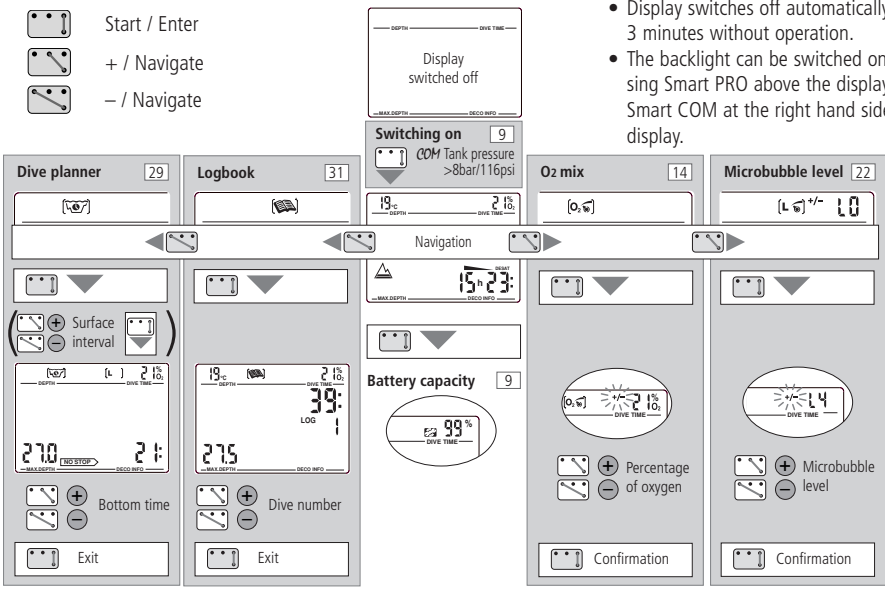

## List of chapters

<b>I</b>	<b>Safety considerations</b>	<b>2</b>
	Introduction	4
	Important remarks concerning signal words and symbols	4
	Quick reference / Operating scheme	5
	List of chapters	6
<b>II</b>	<b>System and operation</b>	<b>8</b>
1	System description	8
2	Operation	8
2.1	Operating elements	8
2.2	SmartTRAK	8
2.3	Switching on the display	9
2.4	Checking the battery capacity	9
2.5	Selection and activation of user functions	9
2.6	Active backlight	10
2.7	Switching off the display	10
3	SOS mode	10
4	<i>COM</i> Setting up Smart COM	10
4.1	Mounting the high pressure hose to the first stage	10
<b>III</b>	<b>Diving with Smart</b>	<b>11</b>
1	Terminology / Symbols	11
1.1	General terminology / Display during no-stop phase	11
1.2	Display during decompression phase / Remaining Bottom Time (RBT)	11
1.3	Nitrox information (O <sub>2</sub> information)	12
2	Attention messages and alarms	13
2.1	Attention messages	13
2.2	Alarms	13
3	Preparation for the dive	14
3.1	Setting the gas mixture	14
3.2	Setting the MB level	14
3.3	<i>COM</i> Additional preparation for the dive with Smart COM	14
3.4	Inspection	14
4	Functions during the dive	15
4.1	Immersion	15
4.2	Dive time	15
4.3	Current depth	15
4.4	Maximum depth	15
4.5	Ascent rate	15
4.6	Partial pressure of oxygen (ppO <sub>2</sub> ) / Maximum Operating Depth (MOD)	16
4.7	Oxygen toxicity (CNS O <sub>2</sub> %)	17
4.8	<i>COM</i> Tank pressure	17
4.9	<i>COM</i> Remaining Bottom Time (RBT)	18
4.10	Decompression information	18

## List of chapters

5	Functions at the Surface	20
5.1	End of a dive	20
5.2	Desaturation time	20
5.3	No-fly time	20
5.4	Microbubble warning	20
6	Diving in mountain lakes	21
6.1	Altitude ranges	21
6.2	Prohibited altitude	21
6.3	Decompression dives in mountain lakes	21
<b>IV</b>	<b>Diving with microbubble levels (MB)</b>	<b>22</b>
1	Comparison of dives with MB level 0 and MB level 5	22
2	Terminology	23
2.1	Display during microbubble (MB) no-stop phase	23
2.2	Display during level stop phase	23
3	Preparation for a dive with microbubble levels (MB levels)	24
3.1	Setting the MB level	24
4	Functions during the dive with microbubble levels	24
4.1	Level stop information	24
4.2	Total time of ascent	25
4.3	Decompression obligation	25
4.4	Level stop and deco stop	26
5	Complete a dive with MB levels	26
<b>V</b>	<b>Gauge mode</b>	<b>27</b>
<b>VI</b>	<b>Dive planner</b>	<b>29</b>
1	Planning a no-stop dive	29
2	Leaving the dive planner	30
<b>VII</b>	<b>Logbook</b>	<b>31</b>
1	Survey	31
2	Operating	31
<b>VIII</b>	<b>Appendix</b>	<b>32</b>
1	Technical Information	32
2	Maintenance	32
3	$\varnothing M$ Conversion of tank pressure	33
4	Warranty	34
5	Index	35

## II System and operation

### 1 System description



Infrared port

Smart displays all important dive and decompression data. Smart has a data memory which stores the dive data. The data can be transmitted with an infrared interface (IrDA) and SmartTRAK software to a Windows® personal computer. SmartTRAK CD software is included with the Smart package. Infrared interfaces are available in PC stores. A list of recommended interfaces is available on the UWATEC homepage ([www.uwatec.com](http://www.uwatec.com)).



Infrared port

SmartTRAK



### 2 Operation



On page 5 you will find an operating schematic.

#### 2.1 Operating elements



Smart has 4 operating contacts B, E, +, – on the outside of the housing. For manual operation, touch base contact B and any one of the other three contacts above the display with moistened fingers ("bridging" contacts).

#### Contact B

Base contact, which has to be touched for all operations.

#### Contact E

Enter contact. It serves to switch on Smart and to confirm or enter the displayed value. It is therefore comparable to the ENTER or RETURN key of a keyboard.

#### + / – Contacts

These allow to navigate between menus and, once inside a menu, to increase or decrease the indicated value.

#### 2.2 SmartTRAK

With SmartTRAK you can transfer dive data to a personal computer and graphically display the data. The following settings may be changed with SmartTRAK:

• Unit system	metric/imperial	• Time limit to reset the O <sub>2</sub> % mix to air	no reset / 1 - 48 hrs.
• Audible attention signal suppression	selective	• COM Minimum reserve pressure at the end of the dive (basis for RBT calculation)	20 – 120 bar (300 - 1750 psi)
• Gauge mode	on / off	• COM Tank pressure alarm	50 - 200 bar (750 - 2900 psi)
• Depth alarm	5 - 100 m (20 - 330 feet)	• COM Workload sensitivity	25 steps
• Backlight illumination duration	2-12 sec.		
• Maximum partial pressure of oxygen (ppO <sub>2</sub> max)	1-1.95 bar		



## 2 Operation

The following data may be recalled with SmartTRAK:

- |                                |   |                                 |   |
|--------------------------------|---|---------------------------------|---|
| • Number of past dives         | ✓ | • Temperature curve             | ✓ |
| • Total duration of past dives | ✓ | • COM Workload curve            | ✓ |
| • Atmospheric pressure         | ✓ | • Alarms and attention messages | ✓ |
| • Dive profile                 | ✓ |                                 |   |
| • Logbook                      | ✓ |                                 |   |

### 2.3 Switching on the display

- automatically, on submerging in water or when adaptation to atmospheric pressure is necessary;
- manually by bridging contacts on housing (B-E).
- COM on opening the tank valve (if connected) (Tank pressure  $\geq$  8 bar / 116 psi).

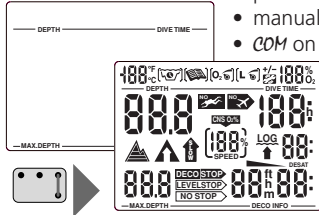

- When Smart is in state of rest no information is displayed but the atmospheric pressure is continuously monitored. If a higher altitude range is detected, Smart switches on for 3 minutes automatically -> 21.
- Smart switches on by bridging the contacts B and E. All segments light up for 5 seconds.



Afterwards the display shows the selected O<sub>2</sub> mix, the temperature and in certain circumstances an altitude range (-> 21). Smart COM displays the tank pressure also.

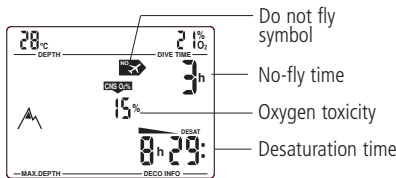

If there is a remaining saturation from the last dive or from a change of altitude, Smart also displays the <do not fly> time, the <do not fly> icon, the current altitude range and the prohibited altitude range (->20).

### 2.4 Checking the battery capacity

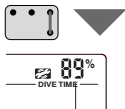

Battery capacity

After switching on Smart you can check the battery capacity by bridging contacts B and E. The remaining capacity is displayed for 3 seconds as a percentage. If the value reaches 0%, the battery warning gets activated (-> 13) and the battery has to be replaced by an authorised SCUBAPRO UWATEC dealer. For a 7-day diving vacation Smart uses between 2 – 5 % of its battery capacity.

### 2.5 Selection and activation of user functions

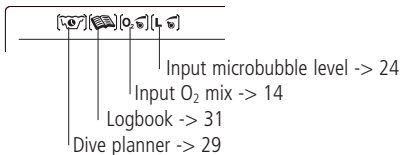

At the surface you can select the dive planner, the logbook and the functions to enter the O<sub>2</sub>% mix and the microbubble level by bridging the contacts + and B or – and B.



After the selection of the desired function you can activate and deactivate it by bridging the contacts B and E.



Details to the user functions are to be found on the pages mentioned above.

## 2 Operation

### 2.6 Active backlight



The display of Smart can be illuminated both on the surface and underwater. The backlight can be switched on by pressing Smart PRO above the display, and Smart COM at the right hand side of the display. The light will turn off automatically after 8 seconds or after the time selected via SmartTRAK. The backlight can only be activated if the computer display is on.

### 2.7 Switching off the display

- automatically after 3 minutes without operation on the surface.
- COM at the surface: automatically after 3 minutes without a reduction of tank pressure. The display switches on again after starting to breathe from the tank.

## 3 SOS mode

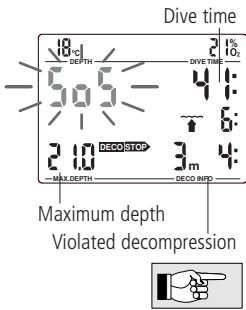

Activation: automatic

If the diver remains above a depth of 0,8 m (3 feet) for more than three minutes without observing a prescribed decompression, the computer switches into SOS mode after the dive and displays <SOS> instead of the depth. The computer is locked from use for the next 24 hours. The display shows the most important information of the dive. Desaturation is further calculated including microbubbles in the tissues. Diving is again possible after 24 hours, but the SOS mode can influence the calculations of Smart for three days after the incident due to the possible presence of microbubbles.

If a diver using Smart experiences a diving accident resulting in decompression sickness, the dive can be analysed by means of the infrared interface and SmartTRAK software.



Serious injury or death may result if a diver does not seek immediate treatment should any signs or symptoms of decompression sickness occur after a dive.

## 4 COM Setting up Smart COM

### 4.1 Mounting the high pressure hose to the first stage

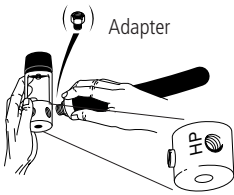

The high pressure hose is mounted on the high pressure outlet (HP outlet) of the first stage of the regulator.

1. Mount the high pressure hose on the HP outlet.  
If the threads do not match, you can obtain an adapter from your diving retailer.
2. Tighten the connection with a matching wrench.

### 1 Terminology / Symbols

The information on the display of Smart varies depending on the kind of dive and the dive phase.



For information about diving with microbubble levels (MB levels) see chapter IV (-> 22).

#### 1.1 General terminology / Display during no-stop phase

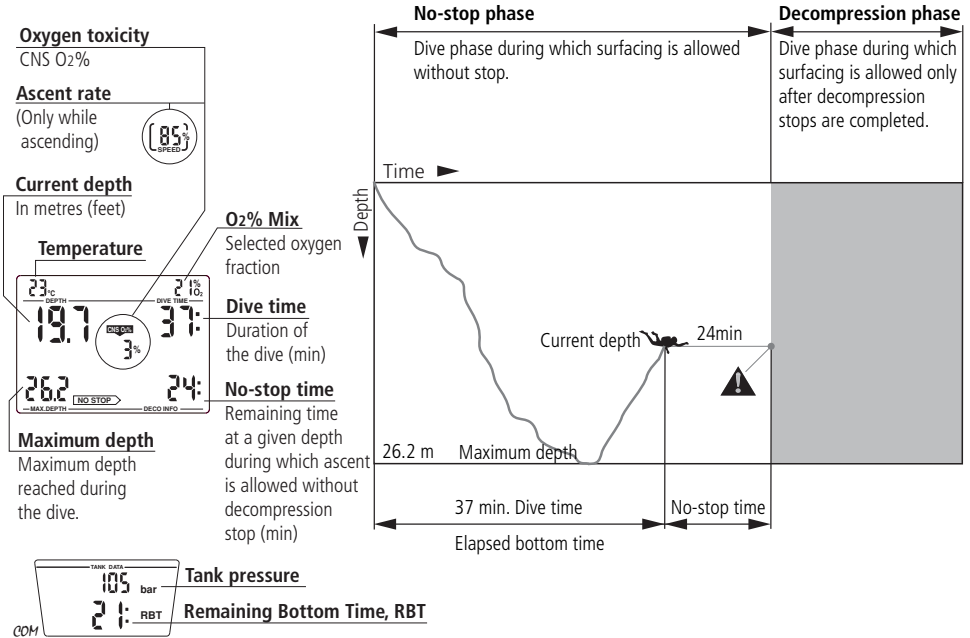

#### 1.2 Display during decompression phase / Remaining Bottom Time (RBT)

##### Decompression stop

All required decompression stops must be observed.

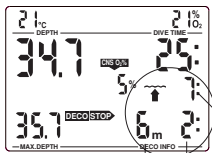

##### Decompression stop depth

Deepest stage is displayed.

##### Decompression stop duration

Prescribed duration of the decompression stop at the displayed decompression stage (minutes).

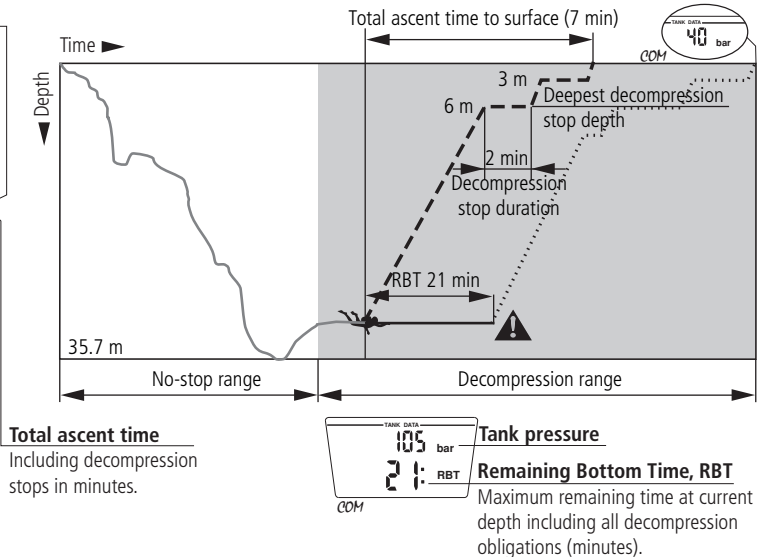

### 1.3 Nitrox information (O<sub>2</sub> information)

For dives with compressed air in normal recreational diving, nitrogen is the decisive gas for the decompression calculations. When diving with Nitrox, the risk of oxygen toxicity rises with the increase of the fraction of oxygen and the increase of depth and can limit dive time and the maximum depth. Smart includes this in the calculations and displays the necessary information:

<O<sub>2</sub>% MIX>

Fraction of oxygen: the fraction of oxygen in the Nitrox mixture can be set between 21% (normal compressed air) and 100% in 1% increments. Your selected mix will be the basis for all calculations.

ppO<sub>2</sub> max

Maximum allowed partial pressure of oxygen: the higher the fraction of oxygen in the mixture, the shallower the dive depth at which this value of the partial pressure of oxygen is reached. The depth at which ppO<sub>2</sub> max. is reached is called Maximum Operating Depth (MOD). Default setting is 1.4 bar, but it can be set by means of SmartTRAK between 1.0 and 1.95 bar. Smart does not display the entered ppO<sub>2</sub> limit, but warns the diver audibly and visually once the depth is reached at which the ppO<sub>2</sub> reaches the maximum allowed value.



The CNS O<sub>2</sub>% value/alarm is not influenced by the selected ppO<sub>2</sub>max. setting.

<CNS O<sub>2</sub>>

Oxygen toxicity: With the increased percentage of oxygen, the oxygen in the tissues (especially in the central nervous system (CNS)) becomes important. If the partial pressure of oxygen rises above 0.5 bar, the CNS O<sub>2</sub> value increases, if the partial pressure of oxygen is below 0.5 bar, the CNS O<sub>2</sub> value decreases. The closer the CNS O<sub>2</sub> value is to 100%, the closer the limit where symptoms can occur -> 17.

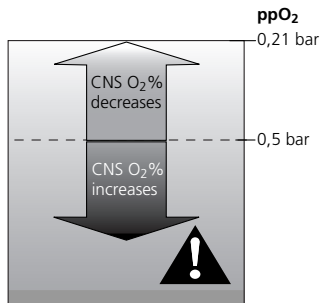

Nitrox diving may only be attempted by experienced divers after proper training from an internationally recognized agency.

## 2 Attention messages and alarms



Smart draws the diver's attention to certain situations and warns the diver of unsafe diving practices. Attention messages and alarms are always visual and audible under water, only visual at the surface except the decompression alarm.



The audible attention messages (but not the alarms) can be switched off selectively with SmartTRAK.



### 2.2 Alarms

Serious injury or death may result from failing to immediately respond to alarms given by Smart.

### 2.1 Attention messages

Attention messages are communicated to the diver visually by symbols, letters or flashing figures. In addition, two short audible sequences can be heard (in an interval of 4 seconds) in two different frequencies under water.

Alarms are given to the diver visually by flashing symbols, letters or figures. In addition, an audible sequence in one frequency can be heard during the whole duration of the alarm.

))) 4 sec ))) (can be switched off)

)))))) (can not be switched off)

Attention messages come up in the following situations (more information can be found on the listed pages):

An alarm occurs in the following situations (more information can be found on the listed pages):

Page

Page

- Maximum Operating Depth / max. ppO<sub>2</sub> is reached 16
- Set maximum depth is reached 15
- Oxygen toxicity reaches 75% 17
- No-stop time = 2 minutes 18
- Prohibited altitude\* (surface mode) 21
- Entering decompression when diving with L0 19
- *COM* Remaining Bottom Time <3 minutes 18
- *COM* Tank pressure has reached set warning level 17
- *COM* Increased workload 17

- Oxygen toxicity reaches 100% 17
- Ignored decompression 19
- *COM* Remaining Bottom Time = 0 18
- Exceeding the prescribed ascent rate (Particular scale of beeps, ->16) 16

• Low battery alarm\*\* see below

Diving with microbubble levels (L1-L5):

- MB no-stop time = 0 24
- MB level stop ignored 25
- MB level reduced 25
- Entering decompression when diving with MB level L1-L5 25

#### Low battery alarm\*\*

The service symbol appears if the battery capacity reaches 0%.

Take the unit to your authorised SCUBAPRO UWATEC retailer.

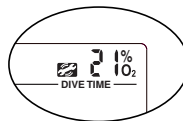

\* without audible attention beep

\*\*without audible alarm

### 3 Preparation for the dive

#### 3.1 Setting the gas mixture (O<sub>2</sub>)



Before every dive and after changing the tank, make sure that the setting of the gas mixture corresponds to the current mixture used. An incorrect setting causes Smart to miscalculate this particular dive. If the fraction of oxygen is set too low this can lead to oxygen poisoning without warning. If the value is set too high decompression sickness may occur. Inaccuracies in the calculations are carried over to repetitive dives.

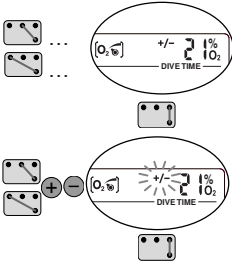

To set the gas mixture, Smart must be in user mode.

1. Bridge contacts B and + or B and – until the symbol for the setting of the O<sub>2</sub> mixture appears.
2. Confirm that you wish to change the displayed oxygen fraction by bridging B and E.
3. Change the oxygen fraction in increments of 1% by bridging contacts B and + to increase or B and – to decrease (21-100%).
4. Confirm the selected percentage with B and E.



Without confirmation the display will disappear after 3 minutes and your entries will not be accepted.

The time to reset the O<sub>2</sub> % mix to air can be set with SmartTRAK between 1 and 48 hours or to "no reset" (default).

#### 3.2 Setting the MB level (L)

See chapter IV, -> 24.

#### 3.3 COM Additional preparation for the dive with Smart COM

The following description of the preparation of a dive is based on the assumption that the high pressure hose is correctly mounted on the HP outlet and Smart COM is connected with the HP hose (-> 10).



If the high pressure hose is not correctly mounted, it will not perform properly and serious injury or death may result.

1. Mount the regulator together with the high pressure hose on the tank.
2. If present, check the reserve valve of your tank, the reserve valve must be open.
3. Open the valve and check the tank pressure (after approx. 10 sec.). If the pressure is insufficient, change the tank.



#### 3.4 Inspection

Make an inspection before each dive:

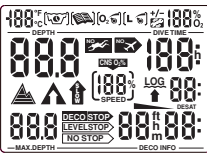

1. Switch on Smart (B-E).
2. Check the test display: are all the elements of the display activated? Use Smart only if all elements of the display are activated.
3. COM Check the connections and instruments for leaks. Never dive with leaky equipment!

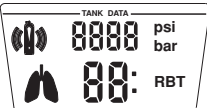

COM

## 4 Functions during the dive

### 4.1 Immersion

After immersion, starting at a depth of about 0.8 m (3 ft), all diving functions are monitored, i.e. depth and dive time displayed, maximum depth stored, saturation of tissues calculated, no-stop time or decompression prognosis determined, ascent rate controlled and displayed and the correctness of the decompression procedure supervised. In addition, Smart COM also shows the tank pressure and about 2 minutes into the dive the Remaining Bottom Time (RBT) is displayed.

### 4.2 Dive time

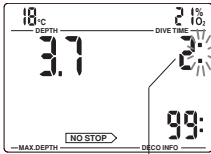

Dive time

The whole time spent below a depth of 0.8m (3 feet) is displayed as dive time in minutes. The time above 0.8m (3 feet) is counted as dive time only if the diver descends again below 0.8m (3 feet) within 5 minutes.

While the dive time is running, the colons on the right of the figures are flashing in one second intervals. Maximum dive time displayed is 199 minutes.



If a dive lasts longer than 199 minutes the dive time display starts again at 0 minutes.

### 4.3 Current depth

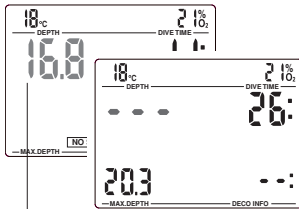

Current depth

Current depth is given in 10 cm increments (1 foot). At a diving depth of less than 0.8 m (3 ft) the display shows <-- -->.



Depth measurement is based on freshwater. Therefore, Smart shows a slightly greater depth when diving in salt water, depending on the salinity of the water. No calculation however is affected.

### 4.4 Maximum depth

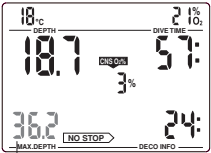

Maximum depth

Maximum depth is only displayed if it exceeds the current depth by more than 1 m (3 feet) (maximum indicator function).

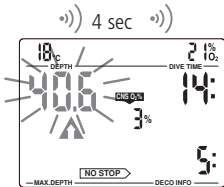

») 4 sec «)»)



#### WARNING

#### Set maximum depth reached

If the maximum depth set with SmartTRAK has been reached (default 40m/130 feet), the current depth will flash and the ascent arrow will be displayed.

Ascend until the ascent arrow disappears.

### 4.5 Ascent rate

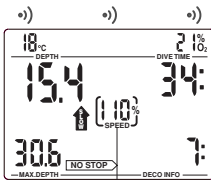

Ascent rate

Optimal ascent rate varies depending on depth between 7 and 20 m/min (23 and 67 ft/min). It is displayed as a percent of the reference variable ascent rate. If the ascent rate is greater than 100% of the set value, the black arrow <SLOW> appears. If the ascent rate exceeds 140%, the arrow starts flashing. Smart provides an audible alarm if the ascent rate is 110% or greater. The intensity of the alarm increases in direct proportion to the degree that the prescribed ascent rate is exceeded.



The prescribed ascent rate must be observed at all times! Exceeding the prescribed ascent rate can lead to microbubbles in the arterial circulation which can lead to serious injury or death due to decompression sickness.

- In case of an improper ascent Smart may require a decompression stop even within the no-stop phase because of the danger of microbubbles formation.
- The decompression duration necessary for the prevention of microbubbles can increase massively if the ascent rate is exceeded.
- From great depth a slow ascent may cause heightened saturation of tissues and an extension of both decompression duration and total ascent time. At shallow depth, a slow ascent may shorten the decompression duration.
- Display of the ascent rate has the priority over <CNS O<sub>2</sub>>.



Ascent rate

Visual alarm

Audible alarm

(10%  
SPEED)



) ) ) )

(40%  
SPEED)



) ) ) )

(60%  
SPEED)



) ) ) )

(80%  
SPEED)



) ) ) )

Reduce ascent rate

Excessive ascent rates for longer periods are entered in the logbook.

#### 4.6 Partial pressure of oxygen (ppO<sub>2 max</sub>) / Maximum Operating Depth (MOD)

) ) 4 sec ) )

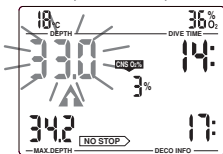

The maximum partial pressure of oxygen ppO<sub>2 max</sub> (default 1.4 bar) determines the Maximum Operating Depth (MOD). Diving deeper than the MOD will expose the diver to oxygen partial pressures higher than the set maximum level.

The ppO<sub>2 max</sub> can be set by means of SmartTRAK between 1.0 and 1.95 bar. The set value and the information about the current ppO<sub>2</sub> are not displayed.



The MOD is a function of ppO<sub>2 max</sub> and the mixture used. If during the dive the MOD is reached or exceeded Smart sends an audible attention message, the ascent arrow appears and the current depth display starts flashing.

Ascend to a shallower depth in order to diminish the danger of oxygen poisoning.



- The MOD should not be exceeded. Disregarding the warning can lead to oxygen poisoning.
- ppO<sub>2 max</sub> should not be set higher than 1.6 bar



### 4.7 Oxygen toxicity (CNS O<sub>2</sub>%)

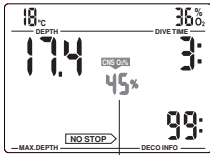

Oxygen toxicity

»)») 4 sec »)»)

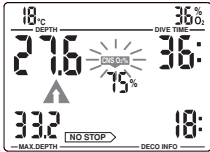

»)»)»)»)»)»)»)»)»)»)»)»)»)»)»)»)»)»)

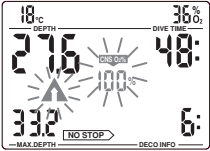

Smart calculates oxygen toxicity from depth values, time and the gas mixture and displays it in the location of the ascent rate. The toxicity is expressed in 1% increments of a maximum tolerated value (O<sub>2</sub> clock). The symbol <CNS O<sub>2</sub>> is displayed together with the percentage.



**WARNING** An audible attention signal goes off if oxygen toxicity reaches 75%. The symbol <CNS O<sub>2</sub>> flashes and the ascent arrow appears.

Ascend to shallower depth to decrease oxygen loading.



**WARNING** When oxygen toxicity reaches 100%, an audible alarm goes off every 4 seconds. <CNS O<sub>2</sub>>, the percentage value and the ascent arrow flash. Danger of oxygen toxicity!

Start ascent at once.

- During an ascent and if the CNS O<sub>2</sub>% value does not increase anymore (due to a lower partial pressure of oxygen), the audible warning is suppressed.
- During the ascent, the display of the oxygen toxicity is replaced by the ascent rate. If the ascent is stopped, the display changes back to the indication of the CNS value.

### 4.8 COM Tank pressure

Tank pressure is indicated in the lower display.



»)») 4 sec »)»)



»)») 4 sec »)»)



The tank pressure is also used for the calculation of the remaining bottom time (RBT) and the workload.



**WARNING** When the tank pressure reaches the set warning pressure (SmartTRAK) an audible alarm goes off and the tank symbol is shown. Default value of the warning pressure: 100 bar (1450 psi).

Do not dive any deeper. Start to ascend soon.



**WARNING** In case of increased workload, Smart COM displays a lung symbol in the lower display and an audible attention message occurs.

In order to prevent additional saturation, reduce exertion, relax and breathe more slowly.

## 4 Functions during the dive

### 4.9 COM Remaining Bottom Time (RBT)



RBT is the time left at the current depth until the point of time when the ascent must be started. The RBT is shown in the lower display. The RBT is calculated on the basis of the current tank pressure, breathing rate, the temperature, and the dive data so far recorded. The RBT is based on the assumption that the tank pressure should amount to the set pressure (default 40 bar/600 psi) at the end of the dive. Alterations can be made with SmartTRAK. A graphic representation of RBT is on page 11.



Never allow the RBT to go below three minutes. If the RBT goes below three minutes there is a danger of insufficient supply of gas mixture for the ascent as well as an increased risk of decompression sickness, and serious injury or death may result!

Correct calculation of RBT when using a reserve or "J" type valve is possible only if the reserve function of the valve is in the open (down) position during the dive.

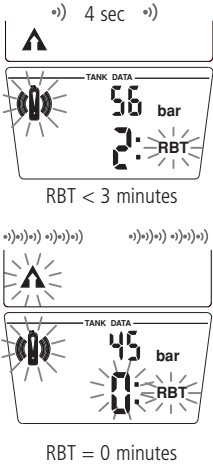

If the RBT drops below three minutes, an audible attention signal is activated, the ascent arrow is displayed and the tank icon and RBT start flashing.

Start ascent immediately.



The RBT value should never reach <0:>. With RBT=0 the remaining tank reserve may not be sufficient for the ascent.

When the last minute has passed (RBT=0) an audible alarm is activated every 4 seconds. The RBT, the ascent arrow and the tank icon start flashing. The audible alarm on exceeding the RBT is suppressed at depths less than 6.5 m (21 ft) if Smart COM is in the no-stop phase.

Start ascent at once

### 4.10 Decompression information

No-stop time is displayed if no decompression stops are necessary. The arrow  is visible if no decompression stops are necessary. The figures indicate no-stop time in minutes.

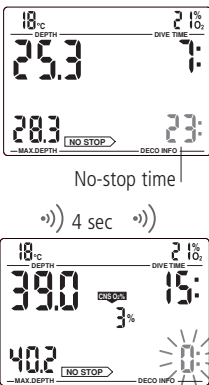

- No-stop display <99:> means remaining time of 99 minutes or more.
- No-stop time is calculated on line and influenced by the current workload and current water temperature.



If no-stop time drops below 3 minutes, an audible attention signal is activated and the no-stop value begins to flash. If no-stop time is less than 1 minute, the no-stop display shows the flashing value "0". In order to prevent a decompression dive, ascend slowly until the no-stop time is 5 minutes or more.



Dives that require decompression stops are not recommended.

**Decompression values**

On entering the decompression phase, the arrow **NO STOP** disappears, the arrow **DECOSTOP** appears and an attention beep goes off. Right beside the arrow, the deepest decompression stage in metres (feet) is displayed. Next to the decompression stop depth, the decompression stop duration of the displayed stage appears in minutes. The display <3m 7:> means that a decompression stop of 7 minutes at a depth of 3m has to be made. When a decompression stop has been finished, the next higher decompression stop is displayed. When all decompression stops have been made, the arrow **DECOSTOP** extinguishes and the arrow **NO STOP** reappears. The indication of time on the lower right shows the no-stop time again.

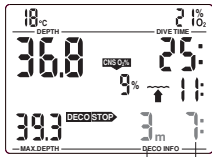

Decompression stop depth  
Decompression time

↻)↻)↻) ↻)↻)↻) ↻)↻)↻) ↻)↻)↻)

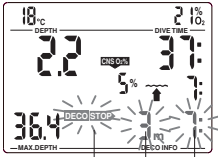

Ignored decompression alarm



**WARNING**

The decompression alarm is activated if the decompression stop is ignored. The arrow **DECOSTOP**, the decompression stop duration and decompression stop depth begin to flash and an audible alarm goes off.

Due to the formation of microbubbles, decompression can increase massively if a decompression stop is ignored. When the surface is reached during the decompression alarm, the arrow **DECOSTOP**, the decompression stop duration and decompression depth continue flashing, in order to point to the risk of a decompression accident. The SOS mode is activated 3 minutes after the dive if corrective action is not taken (-> 10).

If the total (cumulative) duration of the decompression alarm is longer than one minute, it is entered in the logbook.

Descend to the prescribed decompression stop depth immediately!

**Total time of ascent**

As soon as decompression stops are necessary Smart shows the total time of ascent. This includes the ascent time from the current depth to the surface and all decompression stop obligations.

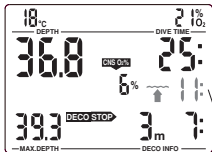

Total time of ascent



The total time of ascent is calculated on the basis of the prescribed ascent rate and a normal workload. Total time of ascent can be subject to change if the ascent rate is not ideal (100%) or if Smart COM detects a higher workload.



**WARNING**

On all dives with Smart, make a safety stop for at least three minutes at a depth of 5 m (15 feet).

## 5 Functions at the surface

### 5.1 End of a dive

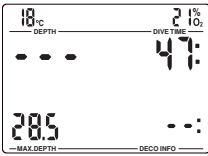

After reaching the surface (<0.8 m/3 ft) Smart remains in dive mode for 5 minutes. The delay allows for surfacing for a short period for orientation.

After 5 minutes the dive is closed and it is entered into the logbook.



For the calculations of the desaturation and no-fly time it is assumed that the diver breathes air while on the surface.

### 5.2 Desaturation time

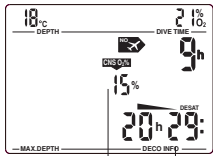

Oxygen toxicity

Desaturation time

After the dive has been closed  **DESAT**, desaturation time in hours and minutes and, if available, oxygen toxicity is displayed. Desaturation time is determined either by oxygen toxicity, nitrogen saturation or the regression of microbubbles, depending on which requires the longer time. Oxygen toxicity (<CNS O<sub>2</sub>>) is displayed and adjusted until the value becomes 0%.

Desaturation time is indicated until the next dive or until it reaches zero.

The display is switched off to save energy three minutes after the last manipulation is made. The calculations are nevertheless continued in the background.

### 5.3 No-fly time

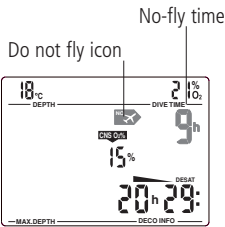

No-fly time

Do not fly icon

The <no-fly time> is indicated beside the icon <do not fly>. <No-fly time> is the time in hours that should pass before a flight and is displayed and adjusted until the value becomes 0 hours.



Flying while Smart displays <do not fly> may lead to serious injury or death from decompression sickness.

### 5.4 Microbubble warning

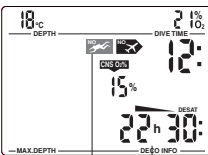

Microbubble warning

Desaturation time

Through repetitive dives microbubbles accumulate in the lungs if the surface interval is not long enough. Ignoring decompression stops or ascending at an excessive ascent rate can also lead to microbubbles in tissues. In order to reduce the risk of decompression sickness for repetitive dives, the surface interval should be planned long enough. If Smart calculates that the formation of microbubbles occurs during the surface interval, it will advise a diver to extend the surface interval via the microbubble warning. The duration of the microbubble warning is visible by entering the dive planner -> 29.



If the <microbubble warning (NO DIVE)> is visible during the surface interval, the diver should not undertake another dive.



If the dive is made in spite of the microbubble warning, the diver must cope with a clearly shorter no-stop time or an extension of decompression. Also, the duration of the microbubble warning at the end of the dive can increase considerably.

## 6 Diving in mountain lakes

### 6.1 Altitude ranges

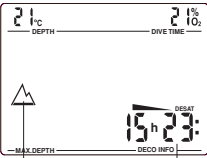

Altitude range 1

Desaturation time  
Adaptation time

Altitude ranges



Smart measures the atmospheric pressure every 60 seconds even while the display is switched off. If the computer detects a sufficient increase in altitude, it switches on automatically and indicates the new altitude range (1-4) and the desaturation time. Desaturation time indicated at this moment refers to adaptation time at this altitude. If the dive starts within this adaptation time, Smart treats it as a repetitive dive, since the body is offgassing.

Altitude is divided into five ranges, which are influenced by barometric pressure. That is why the defined altitude ranges overlap on their fringes. If a mountain lake is reached, the altitude range is indicated at the surface, in the logbook and in the dive planner by a stylised mountain filled with one or more of 4 segments representing the 4 ranges (1-4). Sea level to an altitude of approximately 1000m (3300 feet) is not indicated.

In the following diagram, you can see the approximate breakdown of the altitude ranges:

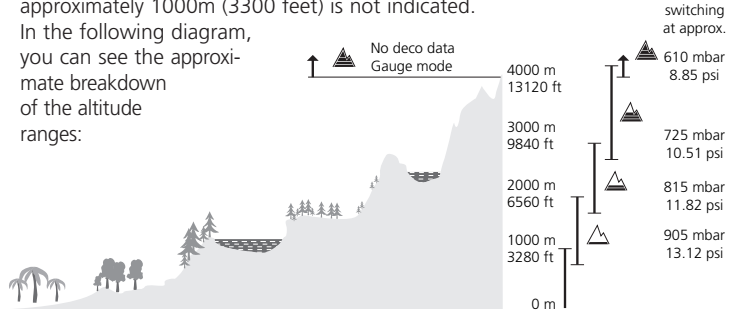

### 6.2 Prohibited altitude



Ascent to altitude range 3 and 4 prohibited.  
Max. allowed altitude:  
2650 m (8694 ft).



Smart shows via flashing altitude segments while at the surface to which altitude the diver may not rise.



Max. altitude: 850 m / 2790 ft



1650 m / 5413 ft



2650 m / 8694 ft



4000 m / 13120 ft

The ascent prohibition can also be displayed together with an altitude range



Example: you are at 1200 m (3937 ft) (altitude range 1) and you may ascend to range 2 only (2650 m / 8694 feet). You may not rise to the altitude range 3 or 4.

### 6.3 Decompression dives in mountain lakes

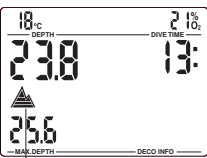

Altitude range 4:

- no deco data
- COM no RBT

In order to assure optimal decompression even at higher altitudes, the 3m (10 ft) decompression stage is divided into a 4 m (13 ft) stage and a 2 m (7 ft) stage in altitude ranges 1, 2 and 3. The prescribed decompression stop depths are, in sequence, 2m / 4m / 6m / 9m... (7 ft / 13 ft / 20 ft / 30 ft...).

If atmospheric pressure is below 620 mbar (8.99 psi) (altitude higher than 4100 m / 13450 ft above sea level), no decompression data is calculated and displayed (automatic gauge mode).

In addition RBT (COM) and the dive planner are not available anymore. The oxygen toxicity and the tank pressure (COM) are still indicated.



## IV Diving with microbubble levels (MB)



The following chapter deals with the characteristics of diving with microbubble levels (MB levels). For general information about displays and features of diving with Smart see chapter III.

**Microbubbles** are tiny bubbles that can build up inside a diver's body during any dive and normally dissipate naturally during an ascent and on the surface after a dive. Dives within no-stop time and observance of decompression stops do not prevent the formation of microbubbles in the venous blood circulation.

Dangerous microbubbles are those migrating into the arterial circulation. The reasons for the migration from the venous blood circulation to the arterial circulation can be a great many microbubbles collecting in the lungs. UWATEC has equipped Smart dive computers with a new technology to protect from microbubbles.

The diver chooses – according to his/her needs – an MB level and influences through it the level of protection from microbubbles. Diving with MB levels requires additional ascent stops (level stops), the ascent is slowed down and the body gets more time to desaturate. This works contrary to the formation of the microbubbles and increases the safety.

Smart features **6 microbubble levels** (L0-L5). Level L0 corresponds to UWATEC's well-known decompression model ZH-L8 ADT and does not require level stops due to microbubble formation. Levels L1 to L5 offer additional protection from microbubble formation with level L5 offering the highest protection.

Similar to the display of information during decompression dives or dives within no-stop time, Smart displays depth and duration of the first level stop as well as the total time of ascent as soon as the MB no-stop time has run out. As the MB no-stop time is shorter than the ordinary no-stop time a diver will be required to carry out a stop (level stop) sooner than a diver using level L0.

If a diver ignores a required level stop, Smart will change over to a lower MB level and the dive can not be completed with the initially chosen MB level. For example, if a diver sets level L4 on Smart prior to the dive and during the dive ignores the stops recommended Smart will automatically adjust the setting to level L3 or lower.

### 1 Comparison of dives with MB level L0 and MB level L5

When two Smarts are used simultaneously, one unit is set for example to MB level L5, the other to L0, the no-stop time will be shortened and level stops will be required before the diver has the obligation of a decompression stop. These additional level stops help dissipate the microbubbles.

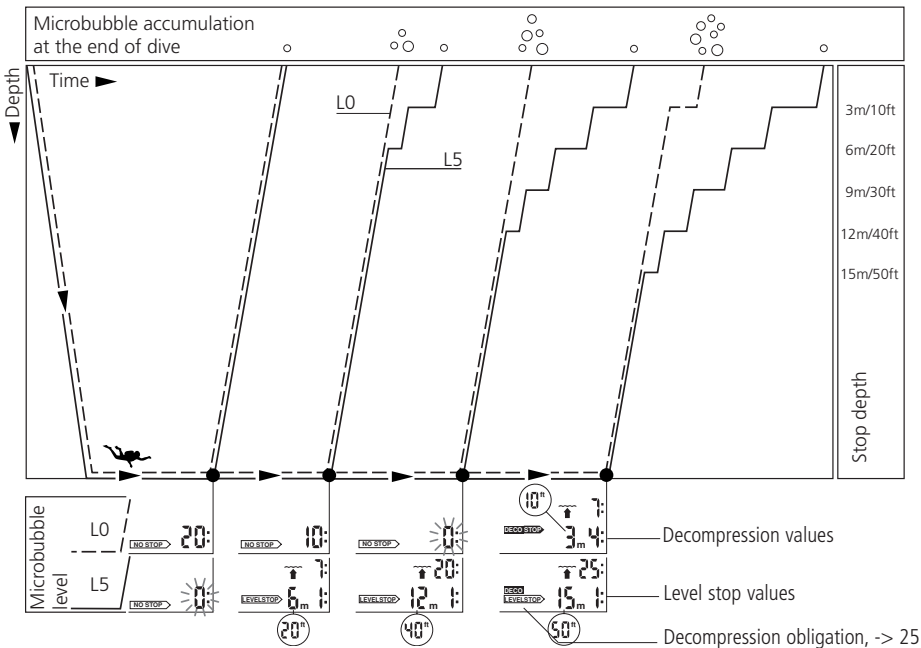

This chapter will exclusively deal with terminology and display features used while diving with MB levels. All other features are described in chapter III (->11).

2.1 Display during microbubble (MB) no-stop phase

An MB level between L1 and L5 was chosen.

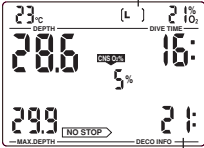

**MB no-stop time**  
Remaining time at a respective depth allowing ascent without level stop.

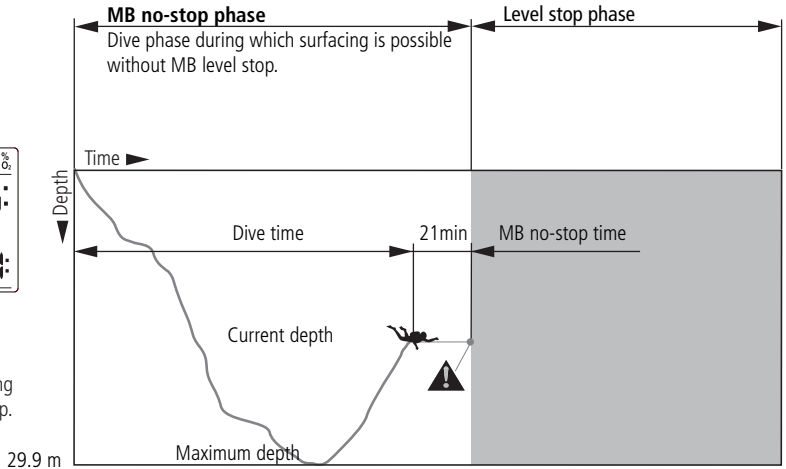

2.2 Display during level stop phase

**Total ascent time**  
including level stops

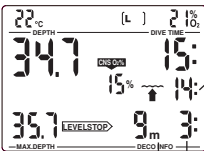

**Level stop depth**  
The deepest level stop depth is displayed.

**Level stop duration**  
The duration of a level stop at a given level stop depth is displayed.

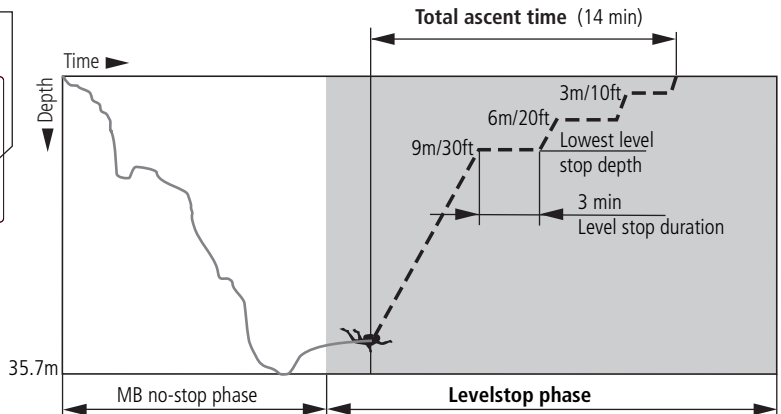

To complete the dive without being reduced to a lower MB level all requested level stops must be observed.

## 3 Preparation for a dive with microbubble levels (MB levels)

### 3.1 Setting the MB level

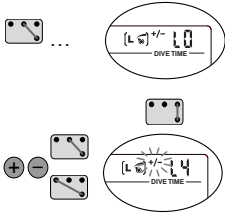

To change the MB level Smart must be in user mode.

1. Bridge contacts B and + or B and – until until the symbol for MB levels appears.
2. Confirm that you wish to change the displayed MB level by bridging B and E.
3. Change MB level by bridging contacts B and + or B and – .
4. Confirm with B and E the selected MB level.

Without confirmation the display will disappear after 3 minutes and your entries will not be accepted.

Smart will display the (L) symbol to confirm that an MB level beyond L0 (L1-L5) has been chosen. If however a level stop is ignored, the new MB level is permanently shown (-> 25).



MB levels have an influence on the dive planner.

## 4 Functions during the dive with microbubble levels

### 4.1 Level stop information

#### Microbubble (MB) no-stop time

While diving with MB levels L1 to L5 Smart will display the MB no-stop time instead of the ordinary no-stop time. Within the MB no-stop time no level stops are required.

The arrow **NO STOP** and the MB level symbol (L) are visible. The remaining MB no-stop time is shown in minutes.

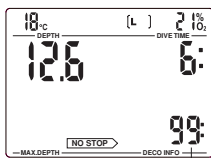

MB no-stop time



- Information and alarms for MB no-stop time and ordinary no-stop time are the same (->18).
- Regardless of the MB level, we generally recommend to perform a slow ascent during the last few metres / feet.

#### Level stop

Level stop icon

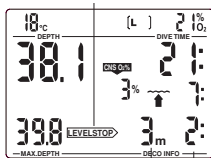

Deepest level stop depth

Level stop duration

Total time of ascent

On entering the level stop phase, the arrow **NO STOP** disappears and the arrow **LEVELSTOP** appears. The **LEVELSTOP** arrow flashes for 8 seconds and an audible attention beep goes off. To complete the dive without being reduced to a lower MB level, all requested level stops must be observed.

To the right of the **LEVELSTOP** arrow, the deepest level stop is displayed in metres/feet. The display <3m 2:> (<10ft 2:>) means that a level stop of 2 minutes at a depth of 3 metres (10ft) has to be observed.

When a level stop obligation is finished, the next higher level stop – if present – is displayed. When all level stops have been observed, the arrow **LEVELSTOP** extinguishes and the arrow **NO STOP** reappears. The indication of time on the lower right shows the MB no-stop time again.



»)) 4 sec »))

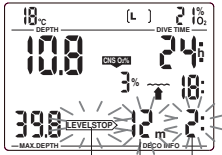

Level stop ignored



The attention message "**Level stop ignored**" is activated if the requested level stop is not observed. An attention beep\* goes off, the arrow **LEVELSTOP**, the depth and duration of the ignored level stop begin flashing.

To complete the dive without being reduced to a lower MB level, you must descend to the prescribed depth immediately!

Microbubble level reduced

»)) 4 sec »))

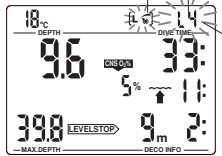

New microbubble level



The warning "**Microbubble level reduced**" is activated if the diver ascends more than 1.5m (5ft) above the required level stop. Smart then reduces the MB level, an attention beep\* goes off and the new MB level will flash until the end of the dive. The level stop for the reduced MB level is now displayed.

To complete the dive without being further reduced to an even lower MB level the new level stop must be observed.



\* Attention beeps can be suppressed via SmartTRAK.

#### 4.2 Total time of ascent

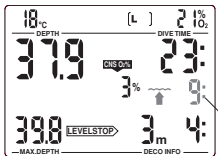

Total ascent time

Smart displays the level stop information and the total time of ascent. This includes the time of ascent as well as all level stops.



The total time of ascent is calculated on the basis of the prescribed ascent rate and a normal workload. Total time of ascent can be subject to change if the ascent rate is not ideal (100%) or if Smart COM detects a higher workload.

#### 4.3 Decompression obligation

Decompression obligation

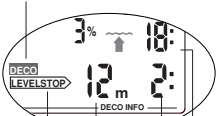

Level stop information



You are close to entering decompression: At the beginning of a decompression phase an attention beep goes off and the **DECO** symbol flashes for 8 seconds.

In order to prevent a dive with long decompression stops it is recommended that you ascend a few metres/feet on seeing this message.

»)) 4 sec »))

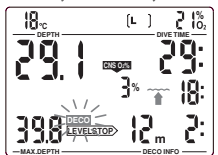

### 4.4 Level stop and deco stop

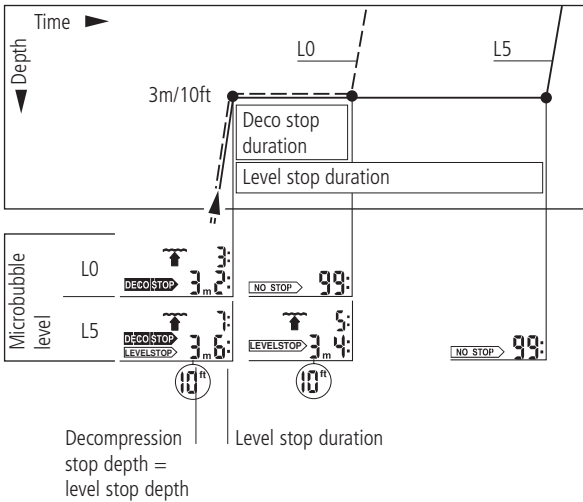

When the level stop depth equals the depth of the first obligatory decompression stop and if you are within 1.5m/5feet of the stop depth itself, Smart shows **DECO STOP** and **LEVEL STOP**. The indicated duration refers to level stop duration.

Since level stops are more restrictive than decompression stops, when all decompression obligations have been observed the display changes from **DECO STOP** **LEVEL STOP** to **LEVEL STOP** only.

### 5 Complete a dive with MB levels

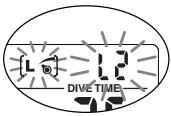

A dive with MB levels is completed the same way as a dive without MB levels (L0) (-> 20), save for the following exceptions:

If the MB level has been reduced during the dive, Smart will display a flashing MB level symbol and the current MB level for five minutes after reaching the surface. The dive is then completed and Smart changes to user mode with the MB level switching back to the original MB setting.

Repetitive dives and microbubble levels: if during a dive a level stop is being ignored and the diver starts another descent shortly afterwards, Smart might immediately request level stops. To complete the dive with the initially set MB level all level stops must be observed.

## V Gauge mode

Gauge mode is provided for those who prefer to utilize their own tables (technical diving) or for those who go freediving in addition to scuba diving.



**WARNING**

Dives in gauge mode are performed at your own risk!

When in gauge mode, the Smart will only display time and depth information, however nitrogen tissue loading and oxygen exposure will be calculated just as they would be during a regular SCUBA dive. It is consequently very important that even when using the Smart in gauge mode, the correct value of your oxygen percentage is set -> 14.

Because the dive computer has residual nitrogen information after having been utilized in gauge mode, it is ready for use as a regular computer at any time after switching it back to computer mode.



**WARNING**

Setting an incorrect mixture carries an inherent risk of decompression sickness and/or oxygen toxicity! An incorrect gas mixture can be lethal! Even before a dive in gauge mode, make sure that the set gas mixture corresponds to the gas mixture currently used.



**WARNING**

- If you are diving trimix or any mix other than oxygen/nitrogen with an oxygen percentage of 21% or higher, input the correct percentage value for the oxygen. The computer will track oxygen exposure correctly and exaggerate the nitrogen loading.
- If you are diving trimix or any mix with a percentage of oxygen lower than 21%, set the computer to 21% oxygen. The computer will exaggerate both the oxygen exposure and the nitrogen loading.

### Enabling the gauge mode (Switching back to the regular dive computer mode)



"write"



To use the Smart in gauge mode, you must first enable the computer via Smart-TRAK and the infrared interface.

Choose "Dive Computer Settings" under the "Options" pop-up window in SmartTRAK. Once the "Dive Computer Settings" dialog box opens, the PC will first "read" the existing settings in the dive computer. Click on "ON" ("OFF" to switch back to the regular dive computer mode) under "Gauge Mode", then click on the right icon in the top row to "write" the changes to the dive computer. The dive computer will now show "OnG" on the display.

### Diving in gauge mode



**WARNING**

In gauge mode oxygen toxicity is not displayed, but it is calculated in the background based on the set oxygen mixture. When the calculated value reaches 75% and 100%, an attention beep and an alarm go off, respectively.

The following information is displayed in gauge mode:

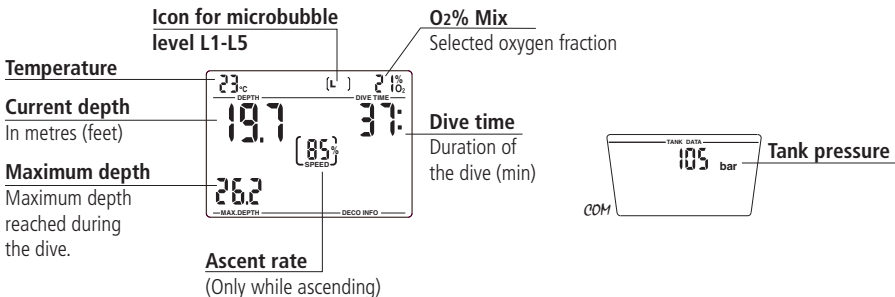

### After diving in gauge mode

After a dive in gauge mode the display shows the following information based on the preset O<sub>2</sub> mixture:

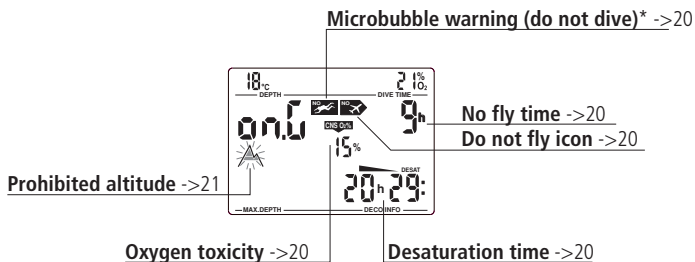

\* The duration of the microbubble warning is visible by entering the dive planner -> 29.

### Diving after violating the dive computer

If the computer has been violated by not respecting a mandatory decompression stop, for instance, the computer will lock out for 24 hours. Gauge mode will not be available during the entire lock-out time.



Basis of the planning:

Smart is equipped with a dive planner which allows the planning of no-stop dives with freely determinable surface intervals.

- selected fraction of oxygen (O<sub>2</sub>% Mix)
- selected microbubble level
- water temperature of the most recent dive
- altitude range (if any)
- status of saturation at the time the dive planner is selected
- assuming a normal workload of the diver and observance of the prescribed ascent rates.



If two or more divers using computers are planning a dive, planning for all divers has to be based on the dive computer showing the shortest no-stop times. Failure to do this may lead to serious injury or death from decompression sickness.

### 1 Planning a no-stop dive

With the contacts B and – or B and – you can select the dive planner at the surface.

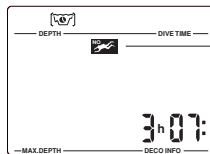
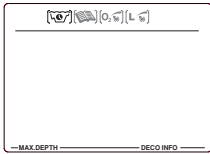

Microbubble warning (Do not dive)

Duration of the warning

The microbubble warning and its duration are displayed if Smart detects an increased risk due to the accumulation of microbubbles.

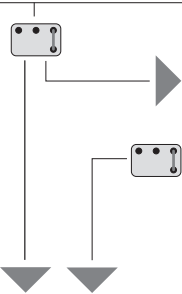

Enter the dive planner with B and E.



Input of the surface interval

The input window for the time interval is displayed if there was a remaining desaturation (DESAT) before the dive planner has been selected. This surface interval between now and the beginning of the dive can be changed with the contacts B and + or B and – in steps of 15 minutes.

If a microbubble warning (no dive) and its duration has been displayed, Smart proposes this time – rounded up to the next 15 minutes – as surface interval. If the proposed interval is shortened, the microbubble warning appears.

Icon for microbubble level L1-L5

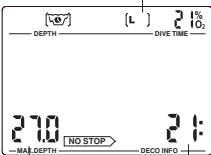

Depth  
No-stop time or MB no-stop time

With B and E you confirm the displayed interval (if applicable), then Smart starts scrolling the no-stop times. The no-stop times are displayed in 3 metre increments (10 ft) and are displayed for every increment for about 3 seconds. The process starts at 3 metre (10 feet).

If a microbubble level has been selected (L1 to 5), Smart shows the microbubble no-stop time instead of the no-stop time.



Depths deeper than the MOD for the selected gas (O<sub>2</sub> mix) are not displayed.

On page 20 you will find further information and safety considerations regarding the microbubble warning.

## 2 Leaving the dive planner

With the contacts B and E (1-2 sec.) you can exit the dive planner. This also occurs after three minutes without operation.

1 Survey

A dive is entered in the logbook if the dive time is longer than 2 minutes. Smart PRO records dive profiles of about 100 hours of diving and Smart COM records the profiles of about 50 hours. This information can be transferred to a PC with the standard infrared interface (IrDA) and the Windows® software SmartTRAK. Up to 99 dives can be displayed directly on the dive computer. The following information of the dive is displayed:

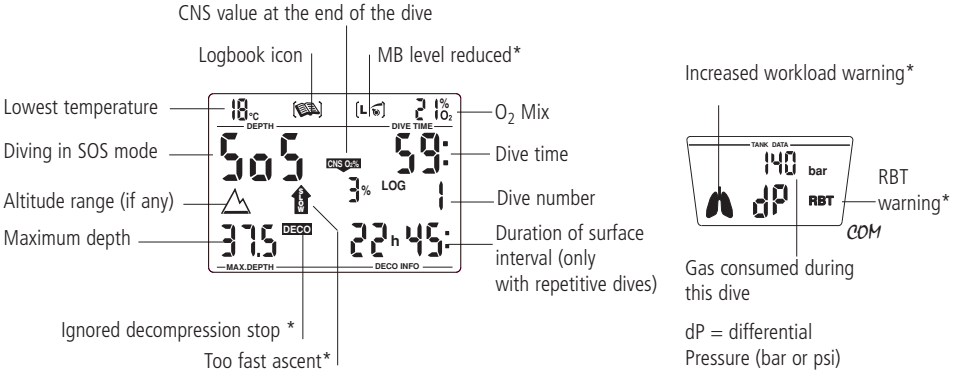

\*Alarms during the dive



If a dive is started within adaptation time (after a change of altitude), the adaptation time is displayed instead of the surface interval.

2 Operation

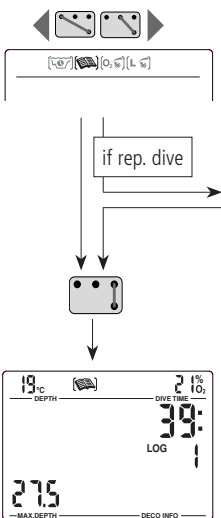

With the contacts B and + or B and – you can select the logbook. With B and E you enter the logbook.

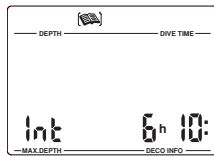

If there was a remaining desaturation time (DESAT) before selecting the logbook, the time since the last dive (surface interval) is displayed.

With B and E you get the most recent dive displayed (LOG 1).

Each bridging of B and + or B and – causes a jump to the next older or more recent dive. Upon continuous bridging of the contacts all dives are displayed successively.

With the contacts B and E you can exit the logbook. The logbook closes automatically after 3 minutes without operation.

## VIII Appendix

### 1 Technical information

**Operating altitude:** with decompression information: sea level up to approx. 4000 m (13120ft);  
w/o decompression, w/o RBT information: usable in gauge mode (at any altitude)

**Max. displayed depth:** 120m (395 ft), resolution between 0.8 m and 99.9 m: 0.1 m, >99.9 m: 1m  
The resolution in feet is always 1 foot



- Do not dive deeper than the limits given by the chosen fraction of oxygen (nitrogen narcosis, oxygen toxicity).
- Never dive deeper than your training qualification (experience) allows you.
- Always observe local dive depth restrictions.

**Decompression calculation depth range:** 0.8 to 120m (3 to 395 ft)

**Maximum environment pressure:** 13 bar (189 psi)

**High pressure connection:** COM Maximum working pressure: 300 bar (4350 psi)

**Clock:** Quartz timer, display up to 199 minutes

**O<sub>2</sub>% Mix:** Adjustable between 21%O<sub>2</sub> (compressed air) and 100% O<sub>2</sub>

**Operating temperature:** -10° to +50°C (14°F to 122°F)

**Power supply:** Special battery UWATEC LR07

**Life of the battery:** 500 to 1000 dives, depending on the quantity of dives per year and the use of the backlight.

### 2 Maintenance

COM The tank pressure gauge and the parts of Smart COM used to measure the tank pressure should be serviced by an authorized SCUBAPRO UWATEC dealer every second year or after 200 dives (whichever comes first). Aside from that your Smart is virtually maintenance free. All you need to do is to rinse it carefully with fresh water after each use and to have the batteries changed when needed. To avoid possible problems with your Smart, the following recommendations will help assure that it will give you years of trouble free service:



- Avoid dropping or jarring your Smart.
- Do not allow your Smart to be exposed to direct, intense sunlight.
- Rinse your Smart thoroughly with fresh water after each dive.
- **Do not store your Smart in a sealed container; make sure there is free ventilation.**
- If there are problems with operating the contacts, use soapy water to clean Smart and dry it thoroughly. The surface of your Smart housing can be treated with silicone grease. Do not apply grease to the water contacts!
- Do not clean Smart with liquids containing solvent (apart from water).



Take the dive computer to an authorised SCUBAPRO UWATEC dealer in order to change the batteries. The battery replacement is carried out by a SCUBAPRO UWATEC subsidiary. Smart is checked for its technical integrity at the same time. Do not attempt to have the batteries changed by anyone other than an authorised SCUBAPRO UWATEC dealer.



### 3 COM Conversion of tank pressure

Tank pressure indicated in the lower display may differ from the information given by a manometer/ pressure gauge. Smart COM displays pressure always converted to a temperature of 20°C / 68°F, whereas the mechanical pressure gauge displays the current pressure influenced by temperature.

The figure allows you to compare the information given by a conventional pressure gauge and by Smart COM at six different temperatures.

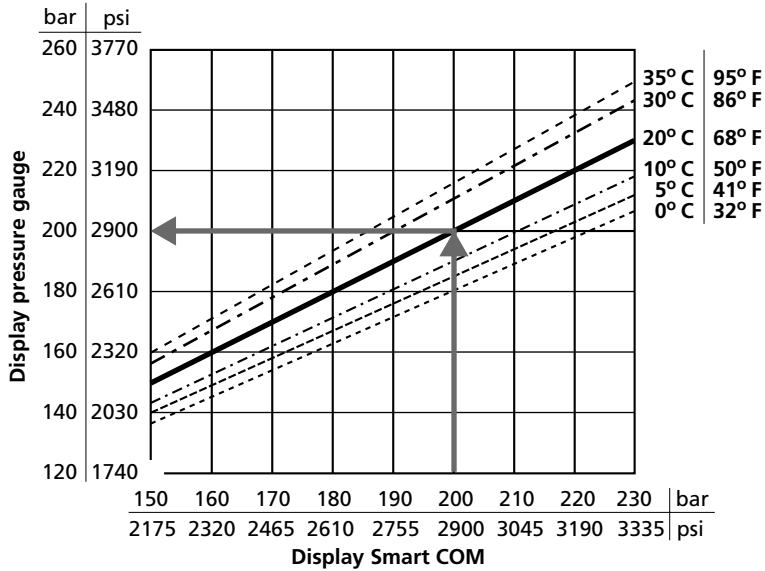

## 4 Warranty

The warranty only covers dive computers which have been bought from an authorised SCUBAPRO UWATEC retailer.

The warranty is given for a period of two years.

Repairs or replacements during the warranty period do not increase the warranty period.

In order to put forward a warranty claim: send the dive computer together with a dated receipt of the purchase to your authorised retailer or an authorised servicing point.

UWATEC reserves the right to determine the merits of a warranty claim and to determine whether the computer will be repaired or replaced.

Excluded are faults or defects due to:

- excessive wear and tear;
- exterior influences, e.g. transport damage, damage due to bumping and hitting, influences of weather or other natural phenomena;
- servicing, repairs or the opening of the dive computer by anybody not authorised by the manufacturer. This especially concerns the change of battery;
- pressure tests which do not take place in water;
- diving accidents.

## 5 Index

Active backlight _____	10	Maximum depth _____	15, 31
Ascent rate _____	11, 13, 15	Microbubbles _____	22-26
Attention messages _____	13	Mounting the HP hose to the first stage _____	10
Battery alarm _____	13	Mountain lakes, Diving in... _____	21, 31
Battery capacity, Checking the... _____	9	Nitrox _____	12
Battery lifetime _____	32	No-stop time _____	18, 22
Beep, Switch off the... _____	13	O <sub>2</sub> fraction _____	11, 12, 14
Bubbles, Warning of... _____	20, 29	O <sub>2</sub> % mix, Set up... _____	14
CNS O <sub>2</sub> _____	2, 3, 11, 12, 13, 31	O <sub>2</sub> partial pressure _____	12, 13, 16
Deco data during decompression phase _____	11	O <sub>2</sub> partial pressure, maximum _____	12, 16
Deco data during no-stop phase _____	11	O <sub>2</sub> toxicity _____	12, 16, 17
Decompression stop, Ignored... _____	13, 19	Oxygen..., see "O <sub>2</sub> ..."	
Depth, current _____	15	PC, transfer to PC (logbook) _____	31
Desaturation time _____	20	ppO <sub>2</sub> , see O <sub>2</sub> partial pressure	
Dive computer operating _____	3, 8	Premix, setting the gas mixture _____	14
Dive _____	11	RBT _____	11, 13, 18
Dive, end of a dive _____	20	SmartTRAK _____	8, 12, 31
Dive planner _____	29	SOS mode _____	10
Dive time _____	15	Surface interval _____	29, 31
Fly, "no-fly time" _____	9, 20	System _____	8
Gas mixture, Setting... _____	14	Tank pressure (COM) _____	17
Gauge mode _____	27	Technical information _____	32
Interval time _____	29	Warnings _____	13
Light _____	10	Workload (COM) _____	17
Logbook _____	31	Workload, Increased... (COM) _____	17
Maintenance _____	32		

**SCUBAPRO UWATEC Americas**

(USA/Canada/Latin America)

1166 Fesler Street  
El Cajon, CA 92020 USA  
t: +1 619 402 1023  
f: +1 619 402 1554  
[www.scubapro.com](http://www.scubapro.com)

**SCUBAPRO UWATEC Asia Pacific**

1208 Block A, MP Industrial Center  
18 Ka Yip St.  
Chai Wan Hong Kong  
t: +852 2556 7338  
f: +852 2898 9872  
[www.scubaproasiapacific.com](http://www.scubaproasiapacific.com)

**SCUBAPRO UWATEC Australia**

Unit 21, 380 Eastern Valley Way  
Chatswood, N.S.W. 2067  
t: +61 2 9417 1011  
f: +61 2 9417 1044  
[www.scubapro.com.au](http://www.scubapro.com.au)

**SCUBAPRO UWATEC Deutschland**

(Germany / Austria / Scandinavia)  
Taucherausrüstungen GmbH  
Rheinvogtstraße 17  
79713 Bad Säckingen-Wallbach  
t: +49 (0) 7761 921050  
f: +49 (0) 7761 921051  
[www.scubapro-uwatec.de](http://www.scubapro-uwatec.de)

**SCUBAPRO UWATEC Italy**

Via G.Latiro 45  
I-16039 Sestri Levante (GE)  
t: +39 0185 482 321  
f: +39 0185 459 122  
[www.scubapro-uwatec.it](http://www.scubapro-uwatec.it)

**SCUBAPRO UWATEC Japan**

4-2 Marina Plaza 5F  
Kanazawa-Ku  
Yokohama  
Japan  
t: +81 45 775 2288  
f: +81 45 775 4420  
[www.scubapro.co.jp](http://www.scubapro.co.jp)

**SCUBAPRO UWATEC France**

Les Terriers Nord  
175 Allée Belle Vue  
F-06600 Antibes  
t: +33 (0) 4 92 91 30 30  
f: +33 (0) 4 92 91 30 31  
[www.scubapro-uwatec.fr](http://www.scubapro-uwatec.fr)

**SCUBAPRO UWATEC Benelux**

Avenue des Arts, 10/11 Bte 13  
1210 Bruxelles  
t: +32 (0) 2 250 37 10  
f: +32 (0) 2 250 37 11  
[www.scubapro-uwatec.com](http://www.scubapro-uwatec.com)

**SCUBAPRO UWATEC España**

Pere IV, nº359, 2º  
08020- Barcelona  
t: +34 93 303 55 50  
f: +34 93 266 45 05  
[www.scubapro-uwatec.es](http://www.scubapro-uwatec.es)

**SCUBAPRO UWATEC U.K.**

Vickers Business Centre  
Priestley Road  
Basingstoke, Hampshire RG24 9NP  
England  
t: +44 0 1256 812 636  
f: +44 0 1256 812 646  
[www.scubapro.co.uk](http://www.scubapro.co.uk)

**SCUBAPRO UWATEC Switzerland**

Oberwilerstrasse 16  
CH-8444 Henggart  
t: +41 (0) 52 3 16 27 21  
f: +41 (0) 52 3 16 28 67  
[www.scubapro-uwatec.de](http://www.scubapro-uwatec.de)

[www.uwatec.com](http://www.uwatec.com)

# Operating Manual

English



Smart TEC

UWATEC®

SWISS MADE BY UWATEC AG

## Safety considerations

You must carefully read and understand this entire manual before using your Smart TEC.



Diving has many inherent risks. Even if you follow the instructions of this manual in a careful manner, it is still possible that you may be seriously injured or die from decompression sickness, oxygen toxicity or some other inherent risk of scuba with Nitrox or compressed air. Unless you are fully aware of these risks and are willing to personally accept and assume responsibility for those risks, do not use Smart TEC!

### Guidelines for the use of Smart TEC:

The following guidelines for using Smart TEC are derived from the latest medical research and the recommendations of the American Academy of Underwater Sciences for diving with diving computers. Following these guidelines will greatly increase your safety while diving, but cannot guarantee that decompression sickness or oxygen toxicity will not occur.

- Smart TEC is designed for dives with Nitrox (to a max. 100% O<sub>2</sub>) and compressed air (21% O<sub>2</sub>) only. Do not use Smart TEC for dives made with other mixed gases.
- It is absolutely necessary to check the set mixture before each dive and to compare it to the gas mixture currently used. Always remember: setting an incorrect mixture carries an inherent risk of decompression sickness and/or oxygen toxicity! Maximum deviation from the measured mixture must not exceed 1% O<sub>2</sub>. An incorrect gas mixture can be lethal!
- Only use Smart TEC with open circuit breathing systems. The gas mixture must be determined for each pressure tank you use.
- Only use Smart TEC for diving with an independent breathing apparatus. Smart TEC is not designed for long term exposures with Nitrox.
- Always observe the visual and audible alarm signals of Smart TEC. Avoid situations of increased risk which are marked with a warning sign in this operating manual.
- If the ascent arrow appears, start to ascend. ▲
- If the flashing ascent arrow appears, start to ascend immediately. ▲
- Smart TEC has a ppO<sub>2</sub> warning, the default limits of which are set at 1.4 bar ppO<sub>2</sub>max. This limit can be adjusted via SmartTRAK. An alteration of the ppO<sub>2</sub>max to higher than 1.6 bar is dangerous and we do not recommend this.
- Frequently check the "oxygen clock" (CNS O<sub>2</sub> Limit), especially in the range higher than 1.4 bar ppO<sub>2</sub>. Ascend and finish the dive if the CNS O<sub>2</sub> exceeds 75%.
- Never dive deeper than the Maximum Operating Depth (MOD) pertinent to the gas mixture in use.
- Always check the diving limits considering the oxygen content and standard sports diving procedures (decompression sickness, oxygen toxicity).
- In accordance with the recommended maximum diving limit of all instructional agencies, do not dive deeper than 40 metres/130 feet.
- The danger of nitrogen narcosis has to be taken into consideration. Smart TEC gives no warning about this.
- On all dives with Smart TEC, make a safety stop for at least 3 minutes at 5 metres (15 feet).
- All divers using dive computers to plan dives and indicate or determine decompression status must use their own computer, which they take with them on all dives.
- If Smart TEC fails at any time during the dive, the dive must be terminated, and appropriate surfacing procedures (including a slow ascent and a 3 to 5 minute safety stop at 5 metres/15 ft) should be initiated immediately.
- Comply with the ascent rate and carry out any decompression stop required. If the computer should fail for any reason, you must ascend at a rate of 10m (30 feet) per minute or less.
- On any given dive, both divers in a buddy pair must follow the most conservative dive computer for that particular dive.
- Never dive without a buddy. Smart TEC does not substitute for a dive buddy.
- Only make dives that are appropriate to your level of dive training. Smart TEC does not increase your knowledge of diving.

- Always dive with back-up instruments. Make sure that you always use back-up instrumentation including a depth gauge, submersible pressure gauge, digital bottom timer or dive watch, and have access to decompression tables whenever diving with a dive computer.
- Avoid repeated ascents and descents (yo yo diving).
- Avoid repeated heavy workload while at depth.
- Plan the dives to be shorter if they are made in cold water.
- After finishing the decompression or at the end of a no-stop dive, the final stage of the ascent should be as slow as possible.
- You MUST be familiar with all signs and symptoms of decompression sickness before using Smart TEC! Seek IMMEDIATE treatment for decompression sickness should any of these signs or symptoms occur after a dive! There is a direct correlation between the effectiveness of treatment and the delay between the onset of symptoms and the treatment for decompression sickness.
- Only dive with Nitrox after you have been thoroughly instructed by a recognised institution.

**Repetitive dives**

- Do not start your next dive before your CNS O<sub>2</sub> % status has dropped below 40%.
- Diving with Nitrox: Make sure your surface interval is long enough (just like diving with compressed air). Plan for a minimum surface interval of two hours. Oxygen, too, needs sufficient time to leave the body.
- Match gas mixture to the intended dive.
- Do not attempt a repetitive dive if the microbubble warning  is visible on the display.
- Plan a day without diving once a week.
- If you have to change computers, wait at least 48 hours before carrying out your next dive.

**Altitude and diving**

- Do not dive at altitudes higher than 4000m (13000 feet).
- After a dive do not rise to altitudes that Smart TEC prohibits via the flashing altitude segments. (->25)



**Flying after diving**

- After diving, wait at least 24 hours prior to flying.



Smart TEC dive instrument is a personal protective equipment in compliance with the essential safety requirements of the European Union directive 89/686/EEC. RINA SpA, Via Corsica 12, I-16128 Genoa, notified body no. 0474, have certified the conformity with the European Standard EN 250:2000 and EN 13319:2000.

EN250:2000 Respiratory equipment - Open circuit self contained compressed air diving apparatus - Requirements, testing, marking (pressure gauge test).

EN13319:2000 Diving accessories - Depth gauges and combined depth and time measuring devices - Functional and safety requirements, test methods. Any information on decompression obligation displayed by equipment covered by this standard is explicitly excluded from its scope.

## Introduction

Congratulations on purchasing Smart TEC and welcome to UWATEC. From now on you will enjoy the assistance of the most extraordinary dive computer - equipped with UWATEC's most innovative technology - while diving.

Smart TEC enables you to use up to three different gas mixtures during the same dive. However, for an easy reading this manual mainly refers to dives with a single gas mixture. Information for diving with several gas mixtures is marked with (mm) or has been summarised in special chapters.

We thank you for choosing Smart TEC and we hope you will enjoy safe dives in the future! Further information on UWATEC Smart dive computers and other products by UWATEC can be found on our web page at [www.uwatec.com](http://www.uwatec.com).

To make this manual easier to read we will use the term 'TEC' as an abbreviation for 'UWATEC Smart TEC diving computer' throughout this booklet.

### Safety considerations

*Dive computers provide divers with data; they, however, do not provide the knowledge how this data should be understood and applied. Dive computers cannot replace common sense! You must therefore carefully read and understand this entire manual before using your TEC.*

## Important remarks concerning signal words and symbols

This operating manual makes use of the following icons to indicate especially important comments:

### Remarks

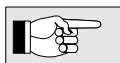

Information and tips which are important for optimal use of the functions of Smart TEC.

### Danger!



Indicates a potentially hazardous situation which, if not avoided, could result in death or serious injury.

## The following symbols are used in the operating manual:



Flashing display



Valid only for dives with more than one gas mixture

-> Page reference  
e.g. ->10

### Audible signals



4 sec. Audible attention signal

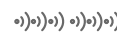
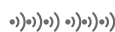

Audible alarm signal

### Instructions for manual input



#### Bridge contacts

Example: bridging contacts B and E



#### Push buttons

Press or press and hold (->9)  
e.g. press the upper left button ●○○



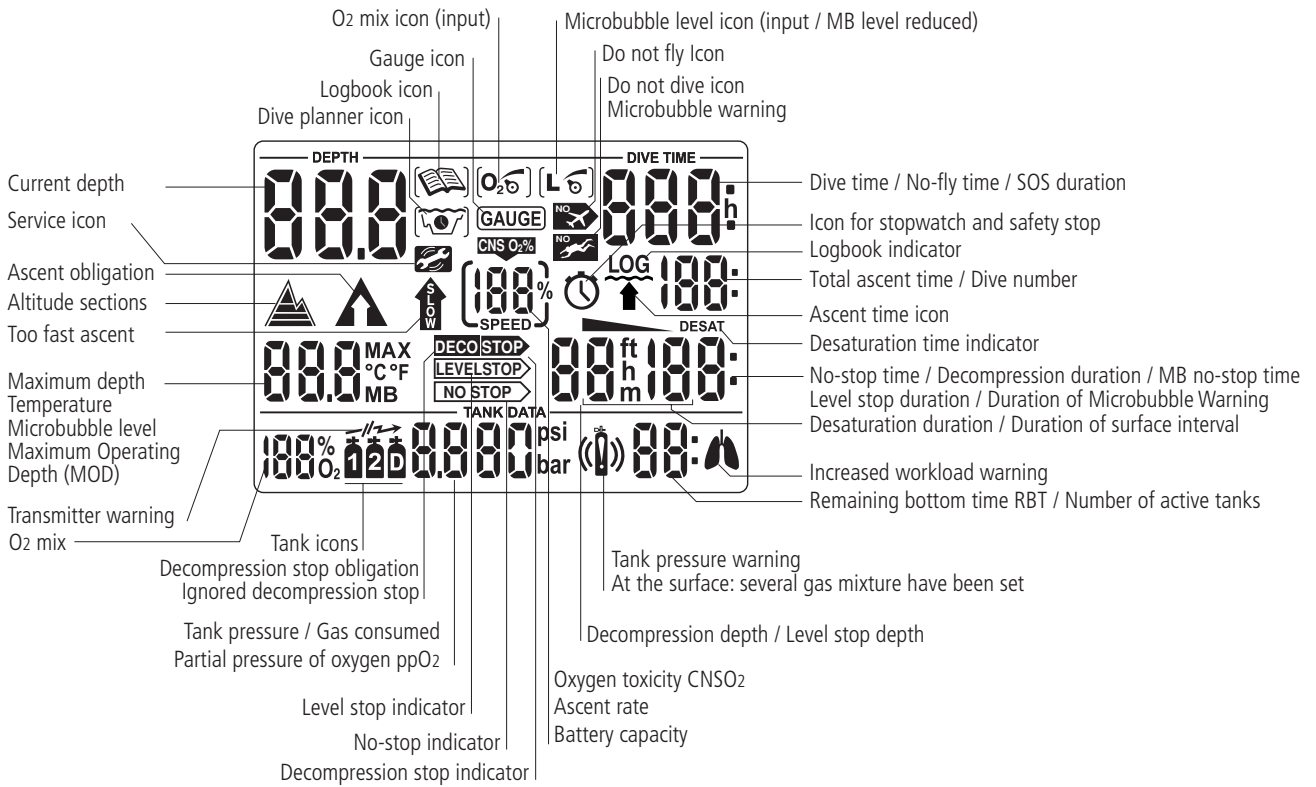

Operating scheme

- Start / Confirmation / Enter
- + / Navigate
- / Navigate

- Select (press) and confirm (press and hold) gas mixtures
- Activate the timer for safety stops (dive mode only, in depths < 6.5 m / 20 ft) (press)
- Operate the stopwatch (gauge mode only) (press)
- Set a bookmark (press)
- Toggle between maximum depth > temperature > MB level > ... (press)
- Intermediate time and reset (in gauge mode only and while stopwatch is active) (press)
- Switching on the backlight (press and hold)

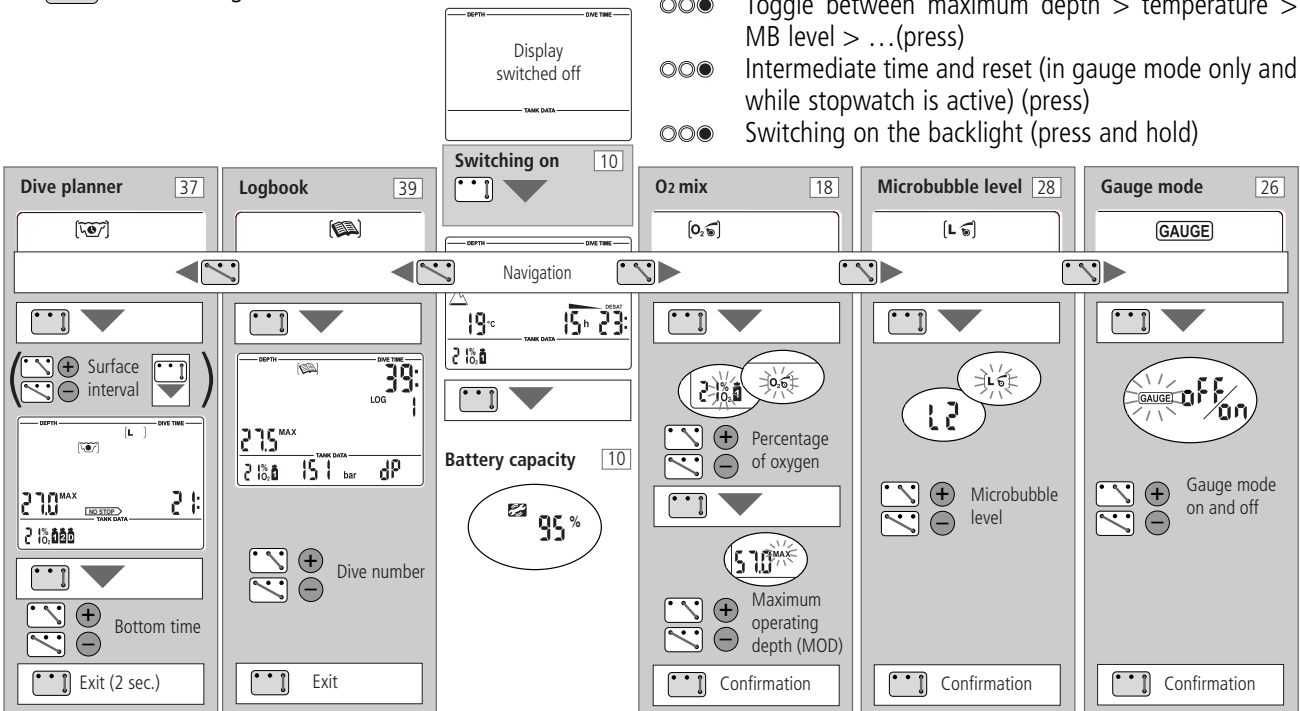

Display switches off automatically after 3 minutes without operation.

## List of chapters

<b>I</b>	<b>Safety considerations</b>	<b>2</b>
	Introduction	4
	Important remarks concerning signal words and symbols	4
	Quick reference / Operating scheme	5
	List of chapters	6
<b>II</b>	<b>System and operation</b>	<b>8</b>
1	System description	8
2	Operation	8
2.1	Operating elements	8
2.2	SmartTRAK	9
2.3	Switching on the display	10
2.4	Checking the battery capacity	10
2.5	Selection and activation of user functions	10
2.6	Active backlight	11
2.7	Switching off the display	11
3	SOS mode	11
4	Setting up Smart TEC	12
4.1	Mounting of transmitter	12
4.2	Pairing of transmitter and dive computer	13
<b>III</b>	<b>Diving with Smart TEC</b>	<b>15</b>
1	Terminology / Symbols	15
1.1	General terminology / Display during no-stop phase	15
1.2	Display during decompression phase / Remaining Bottom Time	15
1.3	Nitrox information (O <sub>2</sub> information)	16
2	Attention messages and alarms	17
2.1	Attention messages	17
2.2	Alarms	17
3	Preparation for the dive	18
3.1	Setting the gas mixture and MOD	18
3.2	Setting the MB level	18
3.3	Preparation for diving with more than one gas mixture	18
3.4	Preparation for the dive and function check	18
4	Functions during the dive	19
4.1	Immersion	19
4.2	Setting bookmarks	19
4.3	Dive time	19
4.4	Current depth	19
4.5	Maximum depth / Temperature	19
4.6	Ascent rate	19
4.7	Partial pressure of oxygen (ppO <sub>2</sub> ) / Maximum Operating Depth (MOD)	20
4.8	Oxygen toxicity (CNS O <sub>2</sub> %)	21
4.9	Tank pressure	21
4.10	Remaining Bottom Time (RBT)	22
4.11	Decompression information	22
4.12	Safety stop timer	23
5	Functions at the surface	24
5.1	End of a dive	24
5.2	Desaturation time	24
5.3	No-fly time	24
5.4	Microbubble warning	24

List of chapters		<b>1</b>
6	Diving in mountain lakes	25
6.1	Altitude ranges	25
6.2	Prohibited altitude	25
6.3	Decompression dives in mountain lakes	25
<b>IV</b>	<b>Gauge mode</b>	<b>26</b>
<b>V</b>	<b>Diving with microbubble levels (MB)</b>	<b>28</b>
1	Comparison of dives with MB level L0 and MB level L5	28
2	Terminology	29
2.1	Display during microbubble (MB) no-stop phase	29
2.2	Display during level stop phase	29
3	Preparation for a dive with microbubble levels (MB levels)	30
3.1	Setting the MB level	30
4	Functions during the dive with microbubble levels	30
4.1	Level stop information	30
4.2	Total time of ascent	31
4.3	Decompression obligation	31
4.4	Level stop and deco stop	32
5	Complete a dive with MB levels	32
<b>VI</b>	<b> Diving with more than one gas mixture</b>	<b>32</b>
<b>VII</b>	<b>Dive planner</b>	<b>37</b>
1	Planning a no-stop dive	37
2	Planning a decompression dive	38
3	Leaving the dive planner	38
<b>VIII</b>	<b>Logbook</b>	<b>39</b>
1	Survey	39
2	Operation	39
<b>IX</b>	<b>Appendix</b>	<b>40</b>
1	Technical information	40
2	Maintenance	40
2.1	Replacing the battery of the transmitter	40
3	Conversion of tank pressure	42
4	Warranty	42
5	FCC	43
6	Index	43

## II System and operation

### 1 System description

TEC displays all important dive and decompression data and comes with a unique multichannel receiver, which can receive tank pressure data from up to 3 transmitters. Each transmitter is mounted at the high pressure (HP) outlet of the regulator, where it measures the tank pressure and radio transmits the information to TEC. UWATEC's specially patented transmission process prevents interference and ensures continuous and reliable reception

TEC has a data memory which stores the dive data. The data can be transmitted with an infrared interface (IrDA) and the SmartTRAK software to a Windows® personal computer.

The SmartTRAK CD software is included with the TEC Package. Infrared interfaces are available in PC stores. A list of recommended interfaces is available on the UWATEC homepage ([www.uwatec.com](http://www.uwatec.com)).

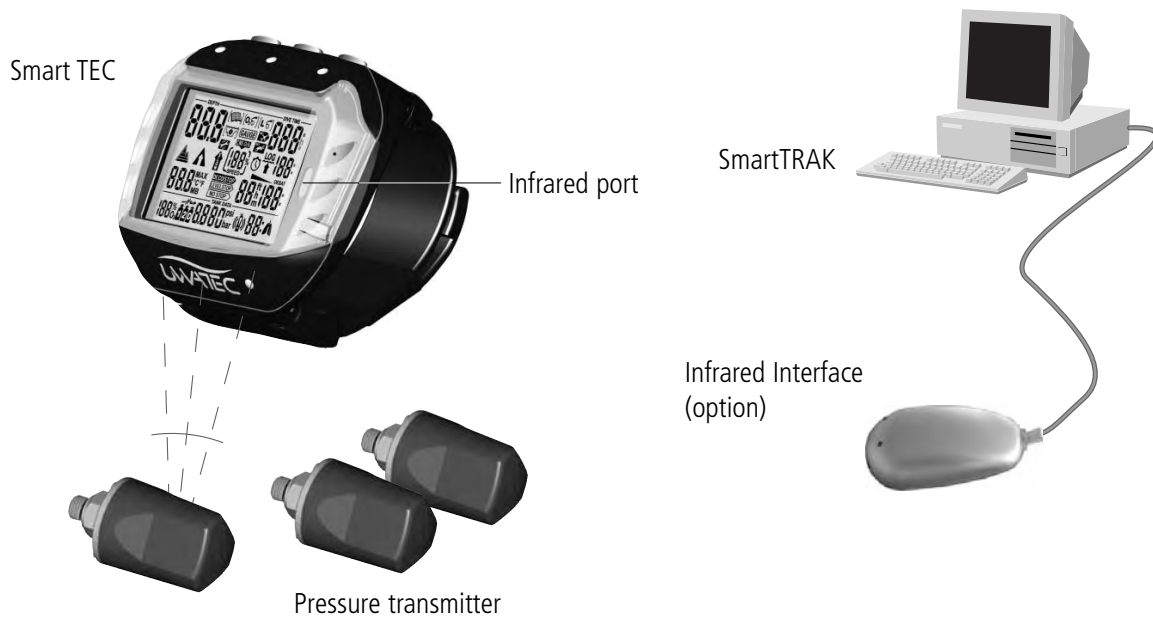

### 2 Operation

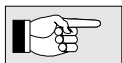

On page 5 you will find an operating schematic.

#### 2.1 Operating elements

##### Contacts

TEC has 4 operating contacts B, E, +, - on the outside of the housing. For manual operation, touch base contact B and any one of the other three contacts above the display with moistened fingers («bridging» contacts).

**Contact B:** Base contact, which has to be touched for all operations.

**Contact E:** Enter contact. It serves to switch on TEC and to confirm or enter the displayed value. It is therefore comparable to the ENTER or RETURN key of a keyboard.

**+ / - Contacts:** These allow to navigate between menus and, once inside a menu, to increase or decrease the indicated value.



**Push buttons** To use the push buttons TEC must be switched on. Operation of the push buttons is divided into «press» and «press and hold (1 second)».

The push buttons ○○○, ○●○ and ○●● activate the following functions:

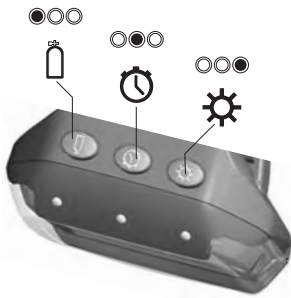

- Select the gas mixture (press)
- Confirm the gas mixture (press and hold)
- Activate the timer for safety stops (dive mode only, in depths < 6.5 m / 20 ft) (press)
- Operate the stopwatch (gauge mode only) (press)
- Set a bookmark (press)
- Toggle between maximum depth > temperature > MB level > ... (press)
- Intermediate time and reset (in gauge mode only and while stopwatch is active) (press)
- Switching on the backlight (press and hold)

## 2.2 SmartTRAK

With SmartTRAK you can transfer dive data to a personal computer and graphically display the data.

The following settings may be changed with SmartTRAK:

- |   |                               |
|---|-------------------------------|
| • Unit system   | metric/imperial               |
| • Audible attention signal suppression  | selective                     |
| • Gauge mode  | ✓                             |
| • Depth alarm   | 5 - 100 m (20 - 330 feet)     |
| • Backlight illumination duration   | 2-12 sec.                     |
| • Maximum partial pressure of oxygen (ppO <sub>2 max</sub> )                  | 1-1.95 bar                    |
| • Time limit to reset the O <sub>2</sub> % mix to air                         | no reset / 1 - 48 hrs.        |
| • Minimum reserve pressure at the end of the dive (basis for RBT calculation) | 20 – 120 bar (300 - 1750 psi) |
| • Tank pressure alarm   | 50 - 200 bar (750 - 2900 psi) |
| • 🗨️ Replace audible RBT alarm by audible attention signal                    | ✓                             |
| • Workload sensitivity  | 25 steps                      |
| • Safety stop duration  | 1-5 min.                      |

The following data may be recalled with SmartTRAK:

- |   |   |
|---|---|
| • Number of past dives                          | ✓ |
| • Total duration of past dives                  | ✓ |
| • Atmospheric pressure                          | ✓ |
| • Pairing information from up to 3 transmitters | ✓ |
| • Dive profile                                  | ✓ |
| • Logbook                                       | ✓ |
| • Temperature curve                             | ✓ |
| • Workload curve                                | ✓ |
| • Alarms and attention messages                 | ✓ |
| • Bookmarks                                     | ✓ |

## 2 Operation

### 2.3 Switching on the display

- automatically, on submerging in water or when adaptation to atmospheric pressure is necessary;
- manually, by bridging contacts on housing (B-E).

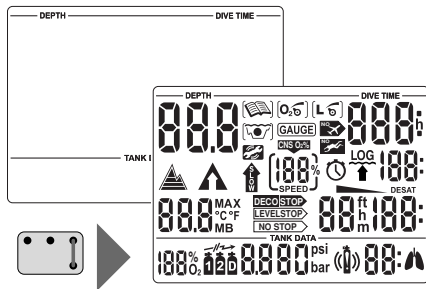

- When TEC is in state of rest no information is displayed but the atmospheric pressure is continuously monitored. If a higher altitude range is detected, TEC switches on for 3 minutes automatically. -> 25
- TEC switches on by bridging the contacts B and E. All segments light up for 5 seconds.

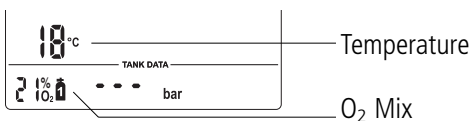

Afterwards the display shows the selected O<sub>2</sub> mix, the temperature and in certain circumstances an altitude range ->25.

If the appertaining transmitter is switched on and located within transmitting distance, the tank pressure is displayed, otherwise <---> will be displayed. If no transmitter has been paired yet, the display will be blank.

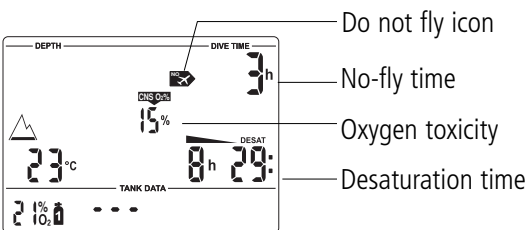

If there is a remaining saturation due to the last dive or change of altitude, TEC also displays the remaining desaturation time, the oxygen toxicity and the "no-fly time" ->24.

### 2.4 Checking the battery capacity

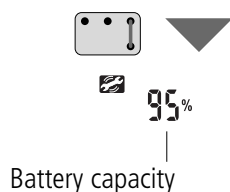

After switching on TEC you can check the battery capacity by bridging the contacts B and E. The remaining capacity is displayed for 3 seconds as a percentage. If the value reaches 0%, the battery warning gets activated (->17) and the battery has to be replaced by an authorised SCUBAPRO UWATEC dealer. For a 7-day diving vacation TEC uses between 2 – 5 % of its battery capacity.

### 2.5 Selection and activation of user functions

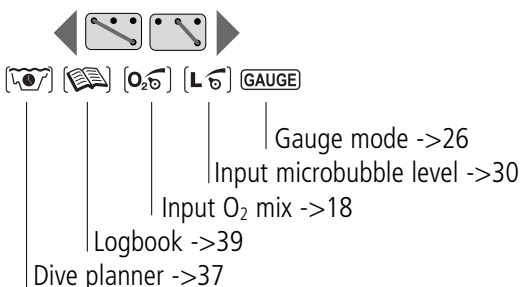

At the surface you can select the dive planner, the logbook and gauge mode as well as the functions to enter the O<sub>2</sub>% mix and the microbubble levels by bridging the contacts + and B or – and B.



After the selection of the desired function you can activate and deactivate it by bridging the contacts B and E.

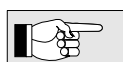

Details to the user functions are to be found on the pages mentioned above.

## 2.6 Active backlight



The display of TEC can be illuminated both on the surface and underwater.

The backlight can be activated by pushing and holding button  for 1 second. The light will turn off automatically after 8 seconds or after the time selected via SmartTRAK.

The backlight can only be activated if the computer display is on.



The active backlight is no substitute for a dive torch. When diving at night or at increased depth we recommend the use of a dive torch.

## 2.7 Switching off the display

On the surface TEC switches off automatically after 3 minutes without operation.

## 3 SOS mode

Time remaining until  
SOS mode switches  
off automatically

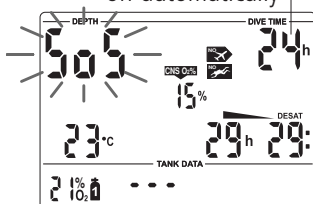

Activation: automatic

If the diver remains above a depth of 0.8m (3 feet) for more than three minutes without observing a prescribed decompression, the computer will automatically switch into SOS mode after the dive.

The display shows the "SOS" sign and the remaining length of the SOS mode. The dive will be entered in the logbook with "SOS". Other than that the SOS mode has no further impact on the displays and functions on the surface.



- Serious injury or death may result if a diver does not seek immediate treatment should any signs or symptoms of decompression sickness occur after a dive.

- Do not dive to treat symptoms of decompression sickness!
- Diving in SOS mode is extremely dangerous and you must assume full responsibility for such behaviour. UWATEC will assume no liability.

Once in the SOS mode, the computer will lock up and will be inoperable as a diving instrument for 24 hours.

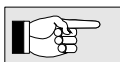

A diving accident can be analyzed at any time in the logbook and downloaded to a PC by means of the infrared interface (IrDA) and the SmartTRAK software.

## 4 Setting up Smart TEC (transmitter and dive computer)

### 4.1 Mounting of transmitter

Each individual pressure tank requires a separate transmitter. The transmitter is mounted at the high pressure (HP) outlet of the regulator's first stage before the first dive.



- Use air and Nitrox components in accordance with the law of the country.

Procedure:

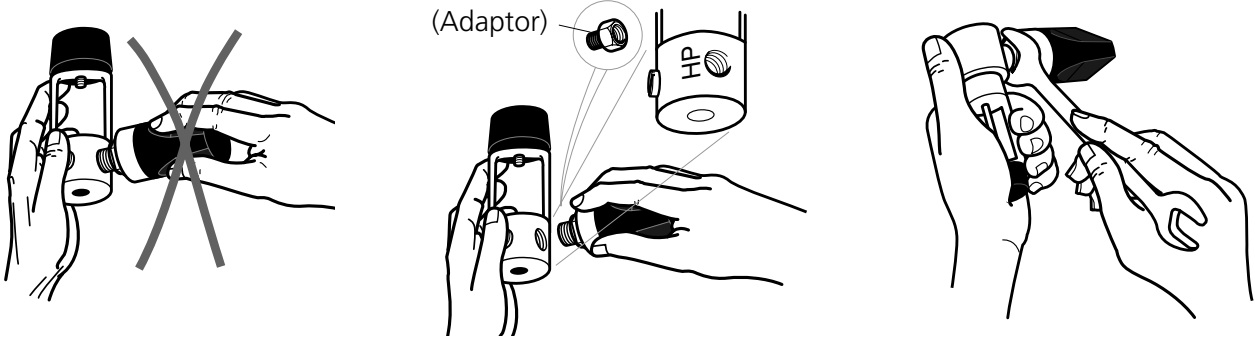

Do not hold the transmitter by its plastic part.

Mount the transmitter at the HP outlet. If the threads do not match, you can get a fitting adaptor at your diving equipment retailer.

Tighten the transmitter by means of a size 3/4" wrench.

The transmitter is best mounted laterally on the regulator.

If pressure tanks 2 and D are carried at the side, make sure the position of their transmitters in relation to TEC resembles that of the transmitter of the main tank on the back.

It is advisable to mount the transmitter on the same side that the computer is located. This is the optimal position for transmission.

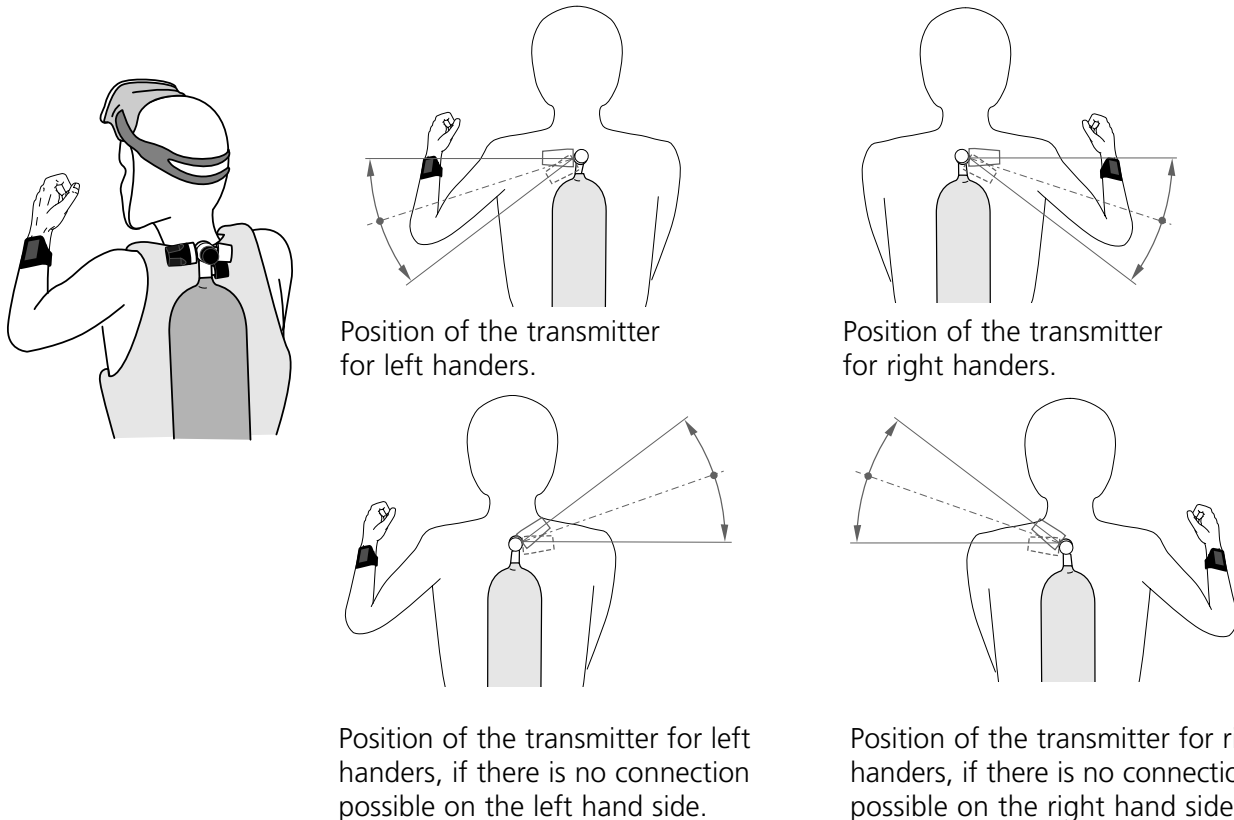

Position of the transmitter for left handers.

Position of the transmitter for right handers.

Position of the transmitter for left handers, if there is no connection possible on the left hand side.

Position of the transmitter for right handers, if there is no connection possible on the right hand side.



## 4 Setting up (transmitter and dive computer)





### 4.2 Pairing of transmitter and dive computer

To receive the data of the transmitters, each transmitter must be assigned to one tank symbol and paired with TEC.

Pairing is necessary:

- before the first use of TEC with the transmitter;
- if you use a new transmitter or a new computer;
- after changing the battery;
- if a different tank symbol (1, 2, or D) is to be paired to the transmitter; e.g. The transmitter is to be paired to tank symbol D instead of tank symbol 2.

To distinguish your tanks and transmitters you should regard the following assignments:

	<b>Bottom Mix</b> Transmitter 1 Lowest oxygen %		<b>Travel Mix</b> Transmitter 2 Intermediate oxygen %		<b>Deco Mix</b> Transmitter 3 Highest oxygen %
---	--	---	--	---	---

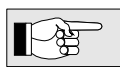

Note that you can also set 2 or even 3 tanks to the same gas mixture. This comes in handy when diving with twin tanks or with double outlet on a single tank.

#### Pairing procedure:

1. Shut the valve, depressurise the regulator and wait for 15 seconds.
2. Switch on TEC (bridge contacts B and E). Select the tank symbol you wish to pair with a certain transmitter by pressing ●○○. Selected tank symbol will flash. Confirm the selection by pressing ●○○ for at least 1 second. Tank symbol stops flashing.

○○○ Tank symbol 2 can only be selected after tank symbol D has been assigned to a certain gas mixture.



3. Move the dive computer and transmitter into the shown position.

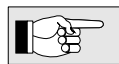

Transmitter and dive computer must be in physical contact during the entire pairing procedure.

4. Open the tank valve. The transmitter briefly sends a pairing sequence to the computer.
5. The dive computer shows a flashing <PAIr> shortly after the valve has been opened.
6. In order to confirm the pairing, the B and E contacts have to be bridged within 5 sec. A beep confirms the input and the <PAIr> display remains still.

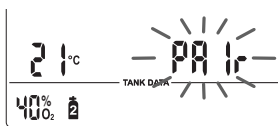

10 sec.



7. "PAIr" disappears after approx. 10 sec.



In case of faulty pairing, the display <FAIL> appears instead of <PAIr>. In that case, completely purge the regulator and repeat the pairing procedure. This is only possible after at least 15 seconds.

## 4 Setting up Smart TEC

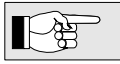

- Pairing of transmitter and dive computer may already be carried out at home and need only be executed once, before the first use.
- A transmitter can only be paired with a single tank symbol at a time. If you try to pair the same transmitter with a second tank symbol, the first pairing will automatically be deleted.
- The pairing of transmitter and tank symbol will remain valid, even if the gas mixture is switched off (-> 34, switching off of gas mixtures).
- You may delete the pairing of transmitter and dive computer by means of the SmartTRAK software.

### How to check if transmitter and computer are paired correctly:

1. Switch on the computer manually (B and E)
2. To check the pairing of a certain tank symbol, press to select the tank symbol. Confirm your choice by pressing for 1 second.
3. Move the computer into transmitting range of the transmitter.
4. Open the tank valve. The transmitter switches on automatically.
5. Check the display: Pairing has been carried out correctly if the pressure is displayed within 5-10 seconds.

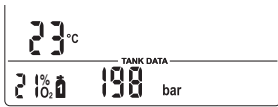

Pairing ok

Check the assignment of all tanks and transmitters as well as the pairing of transmitters and dive computer!

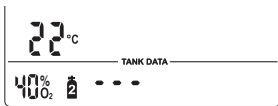

Pairing present, no pressure data available

If the transmitter of a selected pressure tank has been correctly paired, but TEC cannot receive the tank pressure, " - - - " will appear on the display. In that case, check the position of transmitter and dive computer.



Pairing not present

If the specific channel of transmission (i.e. tank) has not been paired, or if an existing pairing has been deleted via SmartTRAK, the display will remain empty. In that case, transmitter and computer must be paired again.

### 1 Terminology / Symbols

The information on the display of TEC varies depending on the kind of dive and the dive phase.

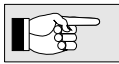

For information about diving with microbubble levels (MB levels) see chapter V ->28. Specific features of "Diving with more than one gas mixture", are described in chapter VI -> 32.

#### 1.1 General terminology / Display during no-stop phase

**Oxygen toxicity**  
CNS O2%

**Ascent rate**  
(Only while ascending)  
[85% SPEED]

**Current depth**  
In metres (feet)

**Tank pressure**

**O2% Mix**  
Selected oxygen fraction tank 1

**Dive time**  
Duration of the dive (min)

**No-stop time**  
Remaining time at a given depth during which ascent is allowed without decompression stop (min).

**RBT, Remaining bottom time**

**No-stop phase**  
Dive phase during which surfacing is allowed without stop.

**Decompression phase**  
Dive phase during which surfacing is allowed only after decompression stops are completed.

Time

Depth

26.2 m Maximum depth

Current depth 24m

37 min. Dive time

No-stop time

Elapsed bottom time

**Maximum depth** ○○○ ▶ **Temperature** ○○○ ▶ **MB Level...**  
Maximum depth reached during the dive

#### 1.2 Display during decompression phase / Remaining Bottom Time (RBT)

**Decompression stop**  
All required decompression stops must be observed.

**Decompression stop depth**  
Deepest stage is displayed.

**Decompression stop duration**  
Prescribed duration of the decompression stop at the displayed decompression stage (minutes).

**Total ascent time**  
Including decompression stops in minutes.

**Remaining bottom time, RBT**  
Maximum remaining time at current depth including all decompression obligations (minutes).

Time

Depth

35.7 m

No-stop range

Decompression range

Total ascent time to surface (7 min)

3m

6m

Deepest decompression stop depth

Decompression stop duration 2 min

RBT 21 min

TANK DATA 40 bar

### 1.3 Nitrox information (O<sub>2</sub> information)

For dives with compressed air in normal recreational diving, nitrogen is the decisive gas for the decompression calculations. When diving with Nitrox, the risk of oxygen toxicity rises with the increase of the fraction of oxygen and the increase of depth and can limit dive time and the maximum depth. TEC includes this in the calculations and displays the necessary information:

<O<sub>2</sub>% MIX>

Fraction of oxygen: The fraction of oxygen in the Nitrox mixture can be set between 21% (normal compressed air) and 100% in 1% increments. Your selected mix will be the basis for all calculations.

ppO<sub>2</sub> max.

Maximum allowed partial pressure of oxygen: the higher the fraction of oxygen in the mixture, the shallower the dive depth at which this value of the partial pressure of oxygen is reached. The depth at which ppO<sub>2</sub> max. is reached is called Maximum Operating Depth (MOD). Default setting is 1.4 bar, but it can be set by means of SmartTRAK between 1.0 and 1.95 bar. When you enter the settings for the gas mixture, TEC will display the ppO<sub>2</sub> max. limit setting and the corresponding MOD. TEC warns the diver audibly and visually once the depth is reached at which the ppO<sub>2</sub> reaches the maximum allowed value.

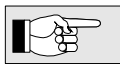

- The partial pressure limit set by means of SmartTRAK can be reduced manually at TEC (->18, setting the gas mixture).
- The CNS O<sub>2</sub>% value/alarm is not influenced by the selected ppO<sub>2</sub>max. setting.

<CNS O<sub>2</sub>>

Oxygen toxicity: With the increased percentage of oxygen, the oxygen in the tissues (especially in the central nervous system (CNS)) becomes important. If the partial pressure of oxygen rises above 0.5 bar, the CNS O<sub>2</sub> value increases, if the partial pressure of oxygen is below 0.5 bar, the CNS O<sub>2</sub> value decreases. The closer the CNS O<sub>2</sub> value is to 100%, the closer the limit where symptoms can occur. See page 21.

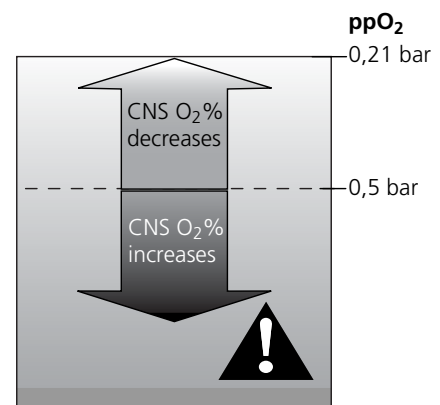

Nitrox diving may only be attempted by experienced divers after proper training from an internationally recognized agency.

## 2 Attention messages and alarms



TEC draws the diver's attention to certain situations and warns the diver of unsafe diving practices. Attention messages and alarms are always visual and audible under water, only visual at the surface except the decompression alarm.

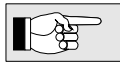

The audible attention messages (but not the alarms) can be selectively switched off with SmartTRAK.



### 2.1 Attention messages

Attention messages are communicated to the diver visually by symbols, letters or flashing figures. In addition, two short audible sequences can be heard (in an interval of 4 seconds) in two different frequencies under water.

••••• 4 sec ••••• (can be switched off)

### 2.2 Alarms

Serious injury or death may result from failing to immediately respond to alarms given by TEC.

Alarms are given to the diver visually by flashing symbols, letters or figures. In addition, an audible sequence in one frequency can be heard during the whole duration of the alarm.

•••••••••• •••••••••• (can not be switched off)

Attention messages come up in the following situations (more information can be found on the listed pages):

	Page
• Maximum Operating Depth / max ppO <sub>2</sub> is reached	20
• Set maximum depth is reached	19
• Oxygen toxicity reaches 75%	21
• No-stop time = 2 minutes	22
• Prohibited altitude* (surface mode)	25
• Entering decompression when diving with L0	23
• Remaining Bottom Time < 3 minutes	22
• Tank pressure has reached set warning level	21
• Increased workload	21
• ∞ Depth for tank switch has been reached	35

An alarm occurs in the following situations (more information can be found on the listed pages):

	Page
• Oxygen toxicity reaches 100%	21
• Ignored decompression	23
• Remaining Bottom Time = 0 (∞ can be switched to attention beep)	22
• Exceeding the prescribed ascent rate (Particular scale of beeps, ->20)	20
• Low battery alarm*	see below

Diving with microbubble levels (L1-L5):

• MB no-stop time = 0	30
• MB level stop ignored	31
• MB level reduced	31
• Entering decompression when diving with MB level L1-L5	31

#### Low battery alarm TEC\*

The service symbol appears if the battery capacity reaches 0%.



Take the unit to your authorised SCUBAPRO UWATEC retailer.

#### Transmitter battery low: \*

<bAt> flashing and alternating with the display of the tank pressure.

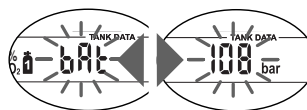

Replace the battery in the transmitter. ->40

\*without audible alarm

\*without audible alarm

### 3 Preparation for the dive

#### 3.1 Setting the gas mixture and MOD [O<sub>2</sub>]



**WARNING**

Before every dive and after changing the tank, make sure that the settings for the gas mixtures correspond with the current mixtures used. An incorrect setting causes TEC to miscalculate this particular dive. If the fraction of oxygen is set too low this can lead to oxygen poisoning without warning. If the value is set too high decompression sickness may occur. Inaccuracies in the calculations are carried over to repetitive dives.

For dives with a single gas mixture, assign the gas mixture to tank symbol 1 and shut off gas mixtures 2 and D. ->34

If more than one gas mixture has been selected, TEC will display at the surface and the number of gas mixtures.

For dives with several gas mixtures please read pages 32 and 13 for further reference.

To set the gas mixture, TEC must be in user mode.

1. Press to choose the tank for the O<sub>2</sub> mixture you are going to enter. The tank symbol will start flashing. Press and hold to confirm your selection.
2. Bridge contacts B and + or B and – until the symbol for the setting of the O<sub>2</sub> mixture appears.
3. Confirm that you wish to change the displayed oxygen fraction by bridging B and E.
4. Change the oxygen fraction in increments of 1% by bridging B and + or B and –. TEC will display the current fraction of oxygen, the maximum partial pressure limit, ppO<sub>2</sub> max (as pre-set by means of SmartTRAK) and the MOD.
5. Confirm the selected percentage with B and E.
6. By bridging B and + or B and – you can change the MOD for the chosen fraction of oxygen. TEC will now display the corresponding partial pressure limit (ppO<sub>2</sub> max) for the new MOD.
7. Confirm your MOD settings with B and E.

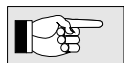
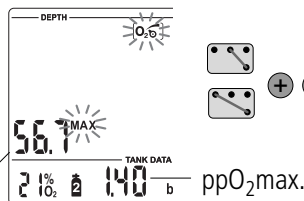
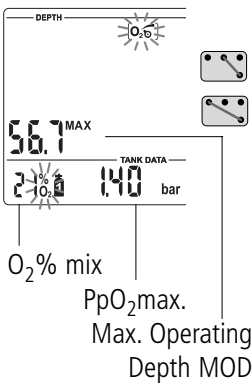
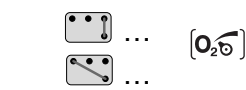

- Without confirmation the display will disappear after 3 minutes and your entries will not be accepted.
- Please refer to page 32 for the setting of gas mixtures for tanks 2 and D.
- The time to reset the O<sub>2</sub> % mix to air can be set with SmartTRAK between 1 and 48 hours or to "no reset" (default).

#### 3.2 [L] Setting the MB level See chapter V, ->28

#### 3.3 Preparation for diving with more than one gas mixture See chapter VI, ->32

#### 3.4 Preparation for the dive and function check

The following descriptions of the preparation are based on the assumption that all transmitters have been correctly mounted at the HP outlet of the regulators (->12) and successfully paired with TEC (->13).

1. Mount the regulator together with the transmitter on the tank



**WARNING**

2. If present, check the reserve valve of your tank, the reserve valve must be open.

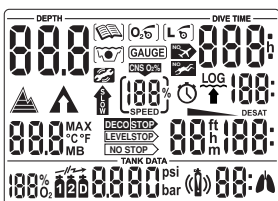

3. Switch on TEC (B-E) and check the test display: Are all elements of the display activated? Do not use TEC if the display does not show all elements.
4. Open the valve (transmitter will switch on automatically) and check the tank pressure (after approx. 10 seconds). If the pressure is insufficient, change the tank.
5. Check the connections and instruments for leaks. Never dive with leaky equipment!  
 Repeat 4 and 5 with all transmitters you are going to use.

## 4 Functions during the dive



### 4.1 Immersion

After immersion, starting at a depth of about 0.8 m (3 ft), TEC automatically selects gas mixture 1, all diving functions are monitored, i.e. depth and dive time displayed, maximum depth stored, saturation of tissues calculated, no-stop time or decompression prognosis determined, ascent rate controlled and displayed and the correctness of the decompression procedure supervised. In addition, TEC also shows the tank pressure and about 2 minutes into the dive the Remaining Bottom Time (RBT) is displayed.

### 4.2 Setting bookmarks

During the dive you can create bookmarks in your dive profile by pressing **⊙●●**. An audible signal confirms the creation of the bookmark. These bookmarks will be graphically displayed in the dive profile of SmartTRAK.

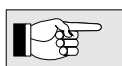

To visualize the bookmarks on the dive profile, you must select the box "Generate bookmarks" under "Program options" in SmartTRAK.

### 4.3 Dive time

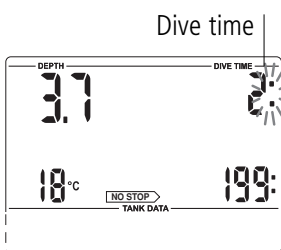

The whole time spent below a depth of 0.8m (3 feet) is displayed as dive time in minutes. The time above 0.8m (3 feet) is counted as dive time only if the diver descends again below 0.8m (3 feet) within 5 minutes.

While the dive time is running, the colons on the right of the figures are flashing in one second intervals. Maximum dive time displayed is 999 minutes.

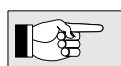

If a dive lasts longer than 999 minutes the dive time display starts again at 0 minutes.

### 4.4 Current depth

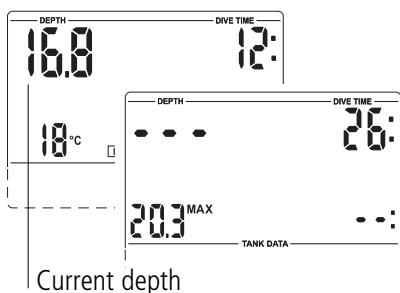

Current depth is given in 10 cm increments (1 foot). On switching on and at a diving depth of less than 0.8 m (3 ft) the display shows <--->.

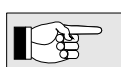

Depth measurement is based on freshwater. Therefore, TEC shows a slightly greater depth when diving in salt water, depending on the salinity of the water. No calculation however is affected.

### 4.5 Maximum depth / Temperature

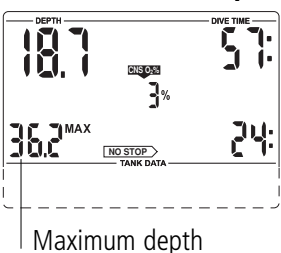

Maximum depth is only displayed if it exceeds the current depth by more than 1 m (3 feet) (maximum indicator function). If maximum depth is not displayed, TEC shows the temperature.

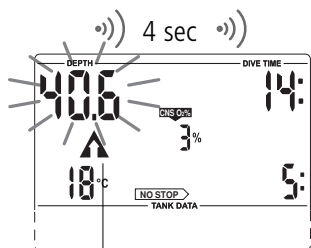

Ascent arrow

**WARNING**

**Set maximum depth reached**

If the maximum depth set with SmartTRAK has been reached (default 40m/130 feet), the display will flash and the ascent arrow will be displayed.

Ascend until the ascent arrow disappears.

### 4.6 Ascent rate

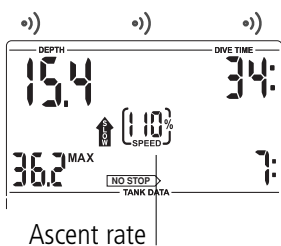

Ascent rate

Optimal ascent rate varies depending on depth between 7 and 20 m/min (23 and 67 ft/min). It is displayed as a percent of the reference variable ascent rate. If the ascent rate is greater than 100% of the set value, the black arrow <SLOW> appears. If the ascent rate exceeds 140%, the arrow starts flashing. TEC provides an audible alarm if the ascent rate is 110% or greater. The intensity of the alarm increases in direct proportion to the degree that the prescribed ascent rate is exceeded.



## 4 Functions during the dive



The prescribed ascent rate must be observed at all times! Exceeding the prescribed ascent rate can lead to microbubbles in the arterial circulation which can lead to serious injury or death due to decompression sickness.

- In case of an improper ascent TEC may require a decompression stop even within the no-stop phase because of the danger of microbubble formation.
- The decompression duration necessary for the prevention of microbubbles can increase massively if the ascent rate is exceeded.
- From great depth a slow ascent may cause heightened saturation of tissues and an extension of both decompression duration and total ascent time. At shallow depth, a slow ascent may shorten the decompression duration.
- Display of the ascent rate has the priority over <CNS O<sub>2</sub>>.



Ascent rate

Visual alarm

Audible alarm

(110%  
SPEED)



•••••

(140%  
SPEED)



•••••

(160%  
SPEED)



•••••

(180%  
SPEED)



•••••

Excessive ascent rates for longer periods are entered in the logbook.

### 4.7 Partial pressure of oxygen (ppO<sub>2 max</sub>) / Maximum Operating Depth (MOD)

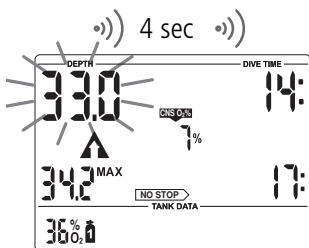

The maximum partial pressure of oxygen ppO<sub>2 max</sub> (default 1.4 bar) determines the Maximum Operating Depth (MOD). Diving deeper than the MOD will expose the diver to oxygen partial pressures higher than the set maximum level.

The MOD and consequently the ppO<sub>2 max</sub> can be reduced manually at TEC (->18, setting the gas mixture, point 6).

In addition the maximum allowed ppO<sub>2</sub> can be set by means of SmartTRAK between 1.0 to 1.95 bar.



The MOD is a function of ppO<sub>2 max</sub> and the mixture used. If during the dive the MOD is reached or exceeded TEC sends an audible attention message, the ascent arrow appears and the current depth display starts flashing.

Ascend to a shallower depth in order to diminish the danger of oxygen poisoning.

Change to the gas mixture that is required at this depth by selecting the appropriate tank symbol.



- The MOD should not be exceeded. Disregarding the warning can lead to oxygen poisoning.
- ppO<sub>2 max</sub> should not be set higher than 1.6 bar.



### 4.8 Oxygen toxicity (CNS O<sub>2</sub>%)

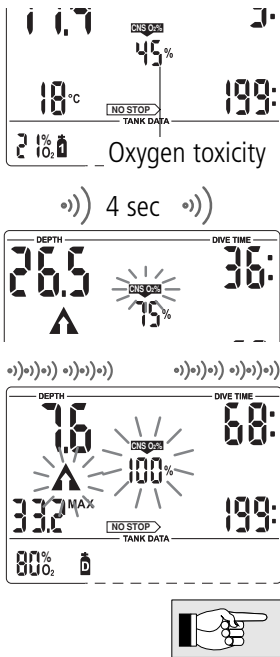

TEC calculates oxygen toxicity from depth values, time and the gas mixture and displays it in the location of the ascent rate. The toxicity is expressed in 1% increments of a maximum tolerated value (O<sub>2</sub> clock). The symbol <CNS O<sub>2</sub>> is displayed together with the percentage.

**WARNING**

An audible attention signal goes off if oxygen toxicity reaches 75%. The symbol <CNS O<sub>2</sub>> flashes and the ascent arrow appears. Ascend to shallower depth to decrease oxygen loading.

**WARNING**

When oxygen toxicity reaches 100%, an audible alarm goes off every 4 seconds. <CNS O<sub>2</sub>>, the percentage value and the ascent arrow flash. Danger of oxygen toxicity! Start ascent at once.

- During an ascent and if the CNS O<sub>2</sub> % value does not increase anymore (due to a lower partial pressure of oxygen), the audible warning is suppressed.
- During the ascent, the display of the oxygen toxicity is replaced by the ascent rate. If the ascent is stopped, the display changes back to the indication of the CNS value.
- TEC will display CNS O<sub>2</sub> % values exceeding 199 % with 199 %.

### 4.9 Tank pressure



The tank pressure is also used for the calculation of the remaining bottom time (RBT) and the workload.

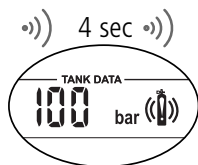

**WARNING**

When the tank pressure reaches the set warning pressure (SmartTRAK) an audible alarm goes off and the tank symbol is shown. Default value of warning pressure: 100 bar (1450 psi) Do not dive any deeper. Start to ascend soon.

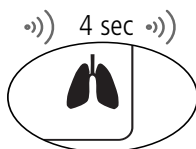

**WARNING**

In case of increased workload, TEC displays a lung symbol and an audible alarm goes off. (The sensitivity of workload can be changed with SmartTRAK). In order to prevent additional saturation, reduce exertion, relax and breathe more slowly.

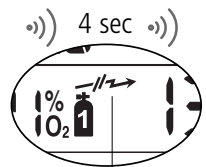

Transmitter warning

**WARNING**

If TEC receives no data for 30 seconds, an audible alarm goes off and the transmitter warning appears. If TEC does not receive pressure data for another 40 seconds, it will activate another audible alarm. RBT and transmitter warning will no longer be displayed. Instead of the tank pressure value TEC will display " - - - ". Check the position of transmitter and TEC. Start ascending at once. TEC will switch back to its normal display as soon as new data is received.

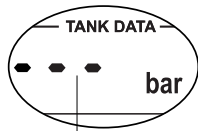

If tank pressure <14 bar/200psi

**WARNING**

If the tank pressure is lower than 14bar/200psi the transmitter switches off and TEC will display " - - - ". Do not let the tank pressure drop below 14bar/200psi.

## 4 Functions during the dive

### 4.10 Remaining Bottom Time (RBT)

RBT is the time left at the current depth until the point of time when the ascent must be started. The RBT is calculated on the basis of the current tank pressure, breathing rate, the temperature, and the dive data so far recorded. The RBT is based on the assumption that the tank pressure should amount to the set pressure (default 40 bar/600 psi) at the end of the dive. Alterations can be made with SmartTRAK. A graphic representation of RBT is on page 15.

During dives with several gas mixtures, the calculation of the RBT is based on the assumption that the diver will use the **current gas mixture** to finish the dive. ->34, 35



#### WARNING

Never allow the RBT to go below three minutes. If the RBT goes below three minutes there is a danger of insufficient supply of gas mixture for the ascent as well as an increased risk of decompression sickness, and serious injury or death may result!

Correct calculation of RBT when using a reserve or "J" type valve is possible only if the reserve function of the valve is in the open (down) position during the dive.

))) 4 sec )))

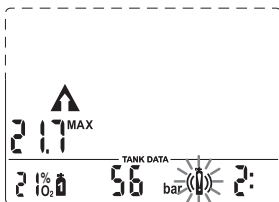

RBT < 3 minutes



#### WARNING

If the RBT drops below three minutes, an audible attention signal is activated, the ascent arrow is displayed and the tank icon start flashing. Start ascent immediately.



#### WARNING

The RBT value should never reach <0:>. With RBT=0 the remaining tank reserve may not be sufficient for the ascent.

When the last minute has passed (RBT=0) an audible alarm is activated every 4 seconds. The RBT, the ascent arrow and the tank icon start flashing. The audible alarm\* on exceeding the RBT is suppressed at depths less than 6.5 m (21 ft) if TEC is in the no-stop phase. Start ascent at once.

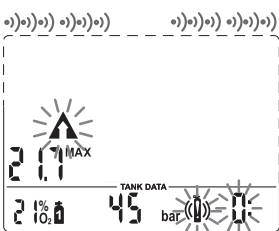

RBT = 0 minutes

\* ))) The audible RBT alarm can be changed to an audible attention signal by means of SmartTRAK. ))) 4 sec )))

### 4.11 Decompression information

No-stop time is displayed if no decompression stops are necessary. The arrow **NO STOP** is visible if no decompression stops are necessary. The figures indicate no-stop time in minutes.

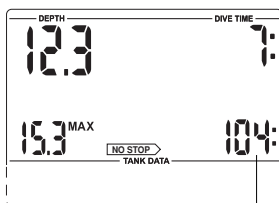

No-stop time

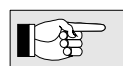

- No-stop display <199:> means remaining time of 199 minutes or more.
- No-stop time is calculated on line and influenced by the current workload and current water temperature

))) 4 sec )))

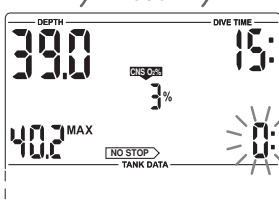

#### WARNING

If no-stop time drops below 3 minutes, an audible attention signal is activated and the no-stop value begins to flash.

If no-stop time is less than 1 minute, the no-stop display shows the flashing value "0".

In order to prevent a decompression dive, ascend slowly until the no-stop time is 5 minutes or more.



#### WARNING

Dives that require decompression stops are not recommended.

**Decompression values**

On entering the decompression phase, the arrow **NO STOP** disappears, the arrow **DECOSTOP** appears and an attention beep goes off. Right beside the arrow, the deepest decompression stage in metres (feet) is displayed. Next to the decompression stop depth, the decompression stop duration of the displayed stage appears in minutes. The display <3m 7:> means that a decompression stop of 7 minutes at a depth of 3m has to be made. When a decompression stop has been finished, the next higher decompression stop is displayed. When all decompression stops have been made, the arrow **DECOSTOP** extinguishes and the arrow **NO STOP** reappears. The indication of time on the lower right shows the no-stop time again.

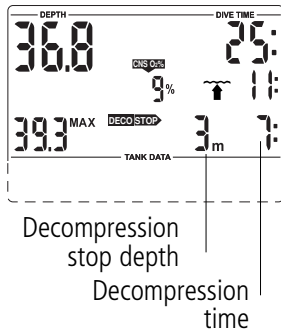

Deco stop depths deeper than 27m (90 ft) are displayed as <-- : -->

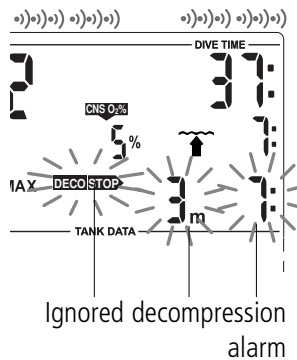

The decompression alarm is activated if the decompression stop is ignored. The arrow **DECOSTOP**, the decompression stop duration and decompression stop depth begin to flash and an audible alarm goes off.

Due to the formation of microbubbles, decompression can increase massively if a decompression stop is ignored. When the surface is reached during the decompression alarm, the arrow **DECOSTOP**, the decompression stop duration and decompression stop depth continue flashing, in order to point to the risk of a decompression accident. The SOS mode is activated 3 minutes after the dive if corrective action is not taken (->11).

If the total (cumulative) duration of the decompression alarm is longer than one minute, it is entered in the logbook.

Descend to the prescribed decompression stop depth immediately!

**Total time of ascent**

As soon as decompression stops are necessary TEC shows the total time of ascent. This includes the ascent time from the current depth to the surface and all decompression stop obligations.

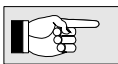
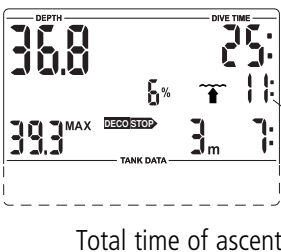

The total time of ascent is calculated on the basis of the prescribed ascent rate and a normal workload. Total time of ascent can be subject to change if the ascent rate is not ideal (100%) or if TEC detects a higher workload.

Ascent time greater than 199 minutes is displayed as <-- -->.



On all dives with TEC, make a safety stop for at least three minutes at a depth of 5 m (15 feet).

**4.12 Safety stop timer**

The safety stop timer displays the time span a diver should spend at the safety stop depth at the end of the dive. The timer is activated by the diver and counts back to zero, starting with the time that was pre-set with SmartTRAK. It can be restarted any number of times. Range: 1 - 5 minutes (default 3 min.)

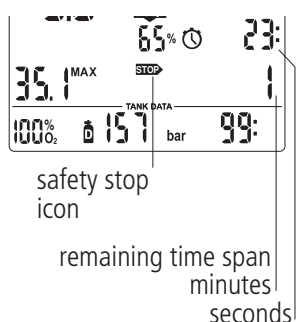

The safety stop timer can be activated under the following conditions: Depth < 6.5 m (21 ft), no-stop display 199 min., gauge mode is switched off.

Activate the safety stop timer by pressing **000**. The timer begins to count backwards and a bookmark will be created in the dive profile.

The safety stop timer will switch off automatically if the depth exceeds 6.5 m (21 ft) or the no-stop phase is shorter than 199 minutes.

## 5 Functions at the surface

### 5.1 End of a dive

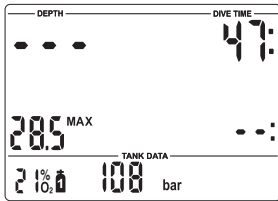

After reaching the surface (<0.8 m/3 ft) TEC remains in dive mode for 5 minutes. The delay allows for surfacing for a short period for orientation.

After 5 minutes the dive is closed and it is entered into the logbook.



For the calculations of the desaturation and no-fly time it is assumed that the diver breathes air while on the surface.

### 5.2 Desaturation time

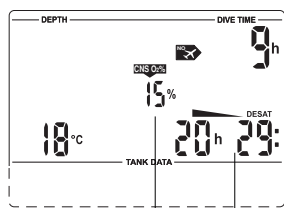

Oxygen toxicity  
Desaturation time

After the dive has been closed **DESAT**, desaturation time in hours and minutes and, if available, oxygen toxicity is displayed. Desaturation time is determined either by oxygen toxicity, nitrogen saturation or the regression of microbubbles, depending on which requires the longer time. Oxygen toxicity (<CNS O<sub>2</sub>>) is displayed and adjusted until the value becomes 0%.

Desaturation time is indicated until the next dive or until it reaches zero.

The display is switched off to save energy three minutes after the last manipulation is made. The calculations are nevertheless continued in the background.

### 5.3 No-fly time

No-fly time

Do not fly icon

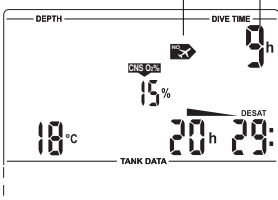

The <no-fly time> is indicated beside the icon <do not fly>. <No-fly time> is the time in hours that should pass before a flight and is displayed and adjusted until the value becomes 0 hours.



Flying while TEC displays <do not fly> may lead to serious injury or death from decompression sickness.

### 5.4 Microbubble warning

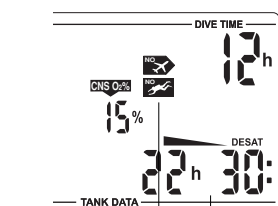

Microbubble warning

Desaturation time

Through repetitive dives microbubbles accumulate in the lungs if the surface interval is not long enough. Ignoring decompression stops or ascending at an excessive rate can also lead to microbubbles in tissues. In order to reduce the risk of decompression sickness for repetitive dives, the surface interval should be planned long enough. If TEC calculates that the formation of microbubbles occurs during the surface interval, it will advise a diver to extend the surface interval via the microbubble warning. The duration of the microbubble warning is visible by entering the dive planner -> 37.



If the <microbubble warning (NO DIVE)> is visible during the surface interval, the diver should not undertake another dive.

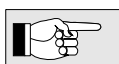

If the dive is made in spite of the microbubble warning, the diver must cope with a clearly shorter no-stop time or an extension of decompression. Also, the duration of the microbubble warning at the end of the dive can increase considerably.

## 6 Diving in mountain lakes



### 6.1 Altitude ranges

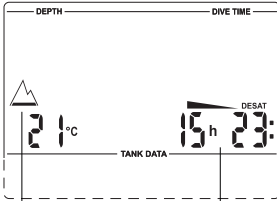

Altitude range 1

Desaturation time  
Adaptation time

Altitude ranges



TEC measures the atmospheric pressure every 60 seconds even while the display is switched off. If the computer detects a sufficient increase in altitude, it switches on automatically and indicates the new altitude range (1-4) and the desaturation time. Desaturation time indicated at this moment refers to adaptation time at this altitude. If the dive starts within this adaptation time, TEC treats it as a repetitive dive, since the body is offgassing.

Altitude is divided into five ranges, which are influenced by barometric pressure. That is why the defined altitude ranges overlap on their fringes. If a mountain lake is reached, the altitude range is indicated at the surface, in the log-book and in the dive planner by a stylised mountain filled with one or more of 4 segments representing the 4 ranges. Sea level to an altitude of approximately 1000m (3300 feet) is not indicated. In the following diagram, you can see the approximate breakdown of the altitude ranges:

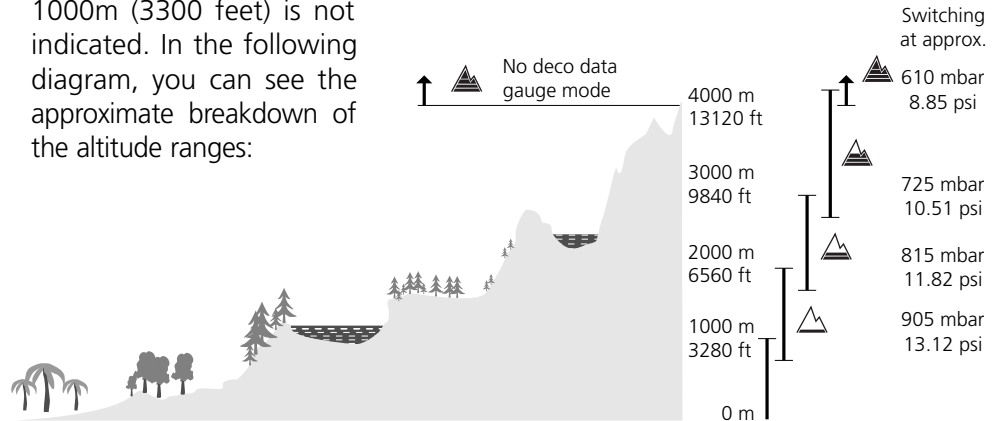

### 6.2 Prohibited altitude



Ascent to altitude range 3 and 4 prohibited.  
Max. allowed altitude:  
2650 m (8694 ft).



TEC shows via flashing altitude segments while at the surface to which altitude the diver may not rise.



Max. altitude:

850 m  
2790 ft

1650 m  
5413 ft

2650 m  
8694 ft

4000 m  
13120 ft

The ascent prohibition can also be displayed together with an altitude range:

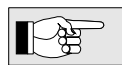

Example: You are at 1200 m (3937 ft) (altitude range 1) and you may ascend to range 2 only (2650 m / 8694 feet). You may not rise to the altitude range 3 or 4.

### 6.3 Decompression dives in mountain lakes

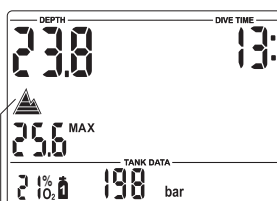

Dive at altitude range 4:

- no deco data
- no RBT

In order to assure optimal decompression even at higher altitudes, the 3m (10 ft) decompression stage is divided into a 4 m (13 ft) stage and a 2 m (7 ft) stage in altitude ranges 1, 2 and 3. The prescribed decompression stop depths are, in sequence, 2m / 4m / 6m / 9m... (7 ft / 13 ft / 20 ft / 30 ft...).

If atmospheric pressure is below 620 mbar (8.99 psi) (altitude higher than 4100 m / 13450 ft above sea level), no decompression data is calculated and displayed (automatic gauge mode). In addition RBT and the dive planner are not available anymore. The oxygen toxicity and the tank pressure are still indicated.

## IV Gauge mode



In gauge mode **ALL** audible and visual alarms and attention messages are turned off. This includes ascent speed, low tank pressure and interrupted signal from transmitter.

In gauge mode TEC will display depth, dive time and tank pressure, the maximum depth is stored, ascent rate and tank pressure are monitored. By pressing  $\odot\odot\odot$  you can switch from maximum depth to temperature and vice versa. You can also activate the stopwatch and check the split time. Gauge mode does not support the calculation of no-stop time or the supervision of decompression. Supervision of ppO<sub>2</sub> max and CNS O<sub>2</sub> % will also be switched off. TEC will display no information about RBT or microbubble development. Bookmarks can be set. The settings for gas mixtures, MOD and microbubble level cannot be set and the dive planner cannot be selected.



- Dives in gauge mode are performed at your own risk!
- After diving in gauge mode you should wait for at least 48 hours before using a decompression computer.

### Switching the gauge mode on and off

Gauge mode can be switched on and off at the surface, if no desaturation time is being prescribed.

After diving in gauge mode, TEC can not be used as dive computer for 48 hours.

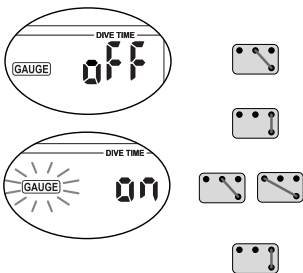

Procedure:

1. Bridge contacts B and + or B and – until the gauge symbol and "on" or "off" are displayed.
2. Confirm with B and E that you wish to activate or deactivate the gauge mode. The gauge symbol starts flashing.
3. By bridging contacts B and + or B and – the gauge mode is switched on and off.
4. Confirm your settings with B and E.

Without confirmation the display will disappear after 3 minutes and your entries will not be accepted.

### Diving in gauge mode

After immersion, starting at a depth of about 0.8m (3 ft), TEC automatically selects gas mixture 1.

The following information is displayed in gauge mode:

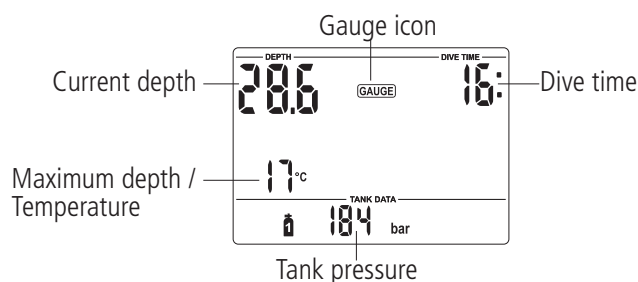

### Changing the gas mixtures in gauge mode

In gauge mode it is up to the diver to decide on a time and depth to change the gas mixture. TEC will not indicate a necessary change of gas mixture. For more information about changing the gas mixture see page 35.

## IV Gauge mode

### Stopwatch

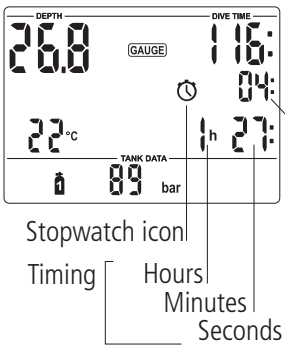

In gauge mode, after immersion, TEC will automatically monitor the dive time and at the same time activate the stopwatch. If the gauge symbol and "on" are displayed (-> 26, point 1) the stopwatch can also be activated at the surface by pressing **○○○**. The stopwatch will run for a maximum of 1 hour at the surface and no longer than 24 hours underwater.

By pressing **○○○** you can start, stop and restart the stopwatch.

Once the stopwatch has been stopped, you can reset the timer to zero with **○○○**.

While the stopwatch is running you can measure split times and return to the timer display by pressing **○○○**. The timekeeping is not interrupted in the meantime.

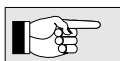
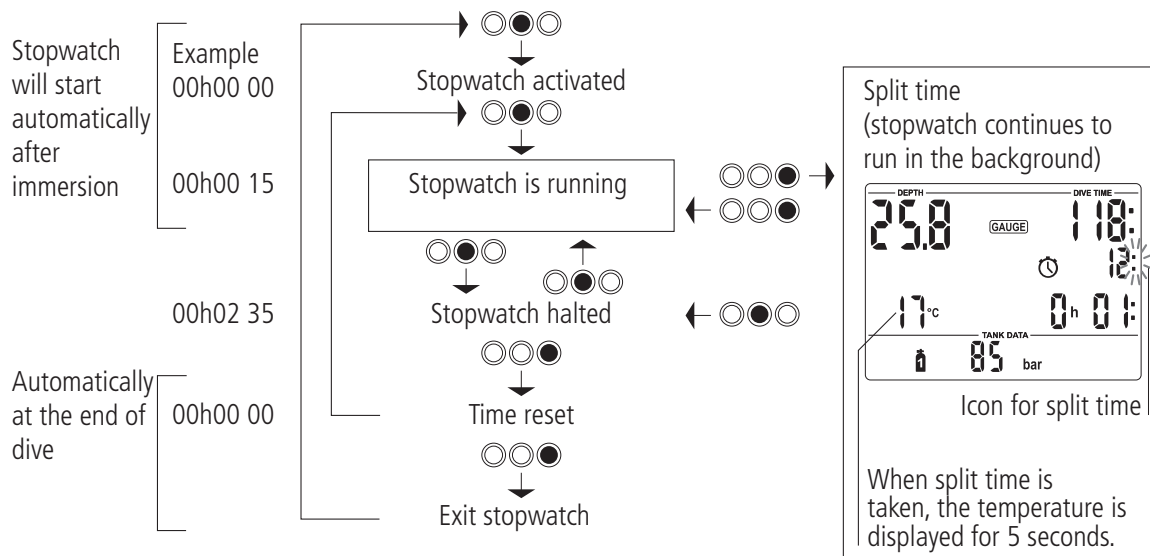

- By pressing **○○○** you can select a different pressure tank even while the stopwatch is running or the split time is being displayed.
- At a diving depth of less than 0.8m (3 ft) the stop watch will automatically measure and display the split time. If the diver descends again the stopwatch timer will be displayed again.

### After diving in gauge mode

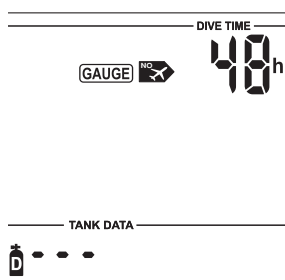

TEC shows the remaining time span during which it cannot be used in computer mode. Once the waiting period is over, the gauge mode can be switched off manually. ->26

The no-fly time after diving in gauge mode is 48 hours.

Desaturation time will not be displayed.



## V Diving with microbubble levels (MB)



The following chapter deals with the characteristics of diving with microbubble levels (MB levels). For general information about displays and features of diving with TEC see chapter III.

**Microbubbles** are tiny bubbles that can build up inside a diver's body during any dive and normally dissipate naturally during an ascent and on the surface after a dive. Dives within no-stop time and observance of decompression stops do not prevent the formation of microbubbles in the venous blood circulation.

Dangerous microbubbles are those migrating into the arterial circulation. The reasons for the migration from the venous blood circulation to the arterial circulation can be a great many microbubbles collecting in the lungs. UWATEC has equipped Smart dive computers with a new technology to protect from microbubbles.

The diver chooses – according to his/her needs – an MB level and influences through it the level of protection from microbubbles. Diving with MB levels requires additional ascent stops (level stops), the ascent is slowed down and the body gets more time to desaturate. This works contrary to the formation of the microbubbles and increases the safety.

Smart TEC features **6 microbubble levels (L0-L5)**. Level L0 corresponds to UWATEC's well-known decompression model ZH-L8 ADT and does not require level stops due to microbubble formation. Levels L1 to L5 offer additional protection from microbubble formation with level L5 offering the highest protection.

Similar to the display of information during decompression dives or dives within no-stop time, TEC displays depth and duration of the first level stop as well as the total time of ascent as soon as the MB no-stop time has run out. As the MB no-stop time is shorter than the ordinary no-stop time a diver will be required to carry out a stop (level stop) sooner than a diver using level L0.

If a diver ignores a required level stop, TEC will change over to a lower MB level and the dive can not be completed with the initially chosen MB level. E.g. If a diver sets level L4 on TEC prior to the dive and during the dive ignores the stops recommended TEC will automatically adjust the setting to level L3 or lower.

### 1 Comparison of dives with MB level L0 and MB level L5

When two Smart TECs are used simultaneously, one unit is set for example to MB level L5, the other to L0, the no-stop time will be shortened and level stops will be required before the diver has the obligation of a decompression stop. These additional level stops help dissipate the microbubbles.

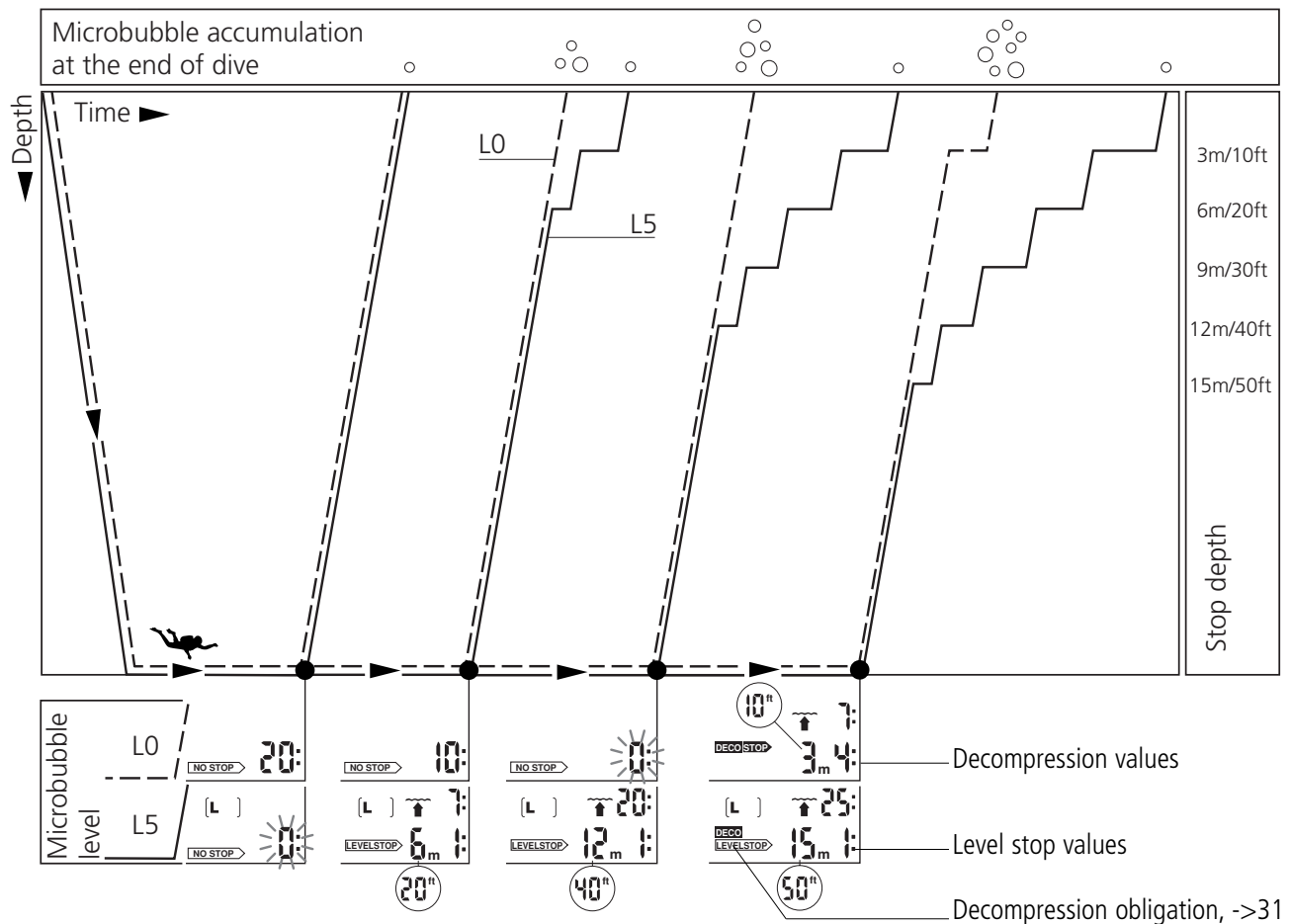



This chapter will exclusively deal with terminology and display features used while diving with MB levels. All other features are described in chapter III (page 15).

2.1 Display during microbubble (MB) no-stop phase

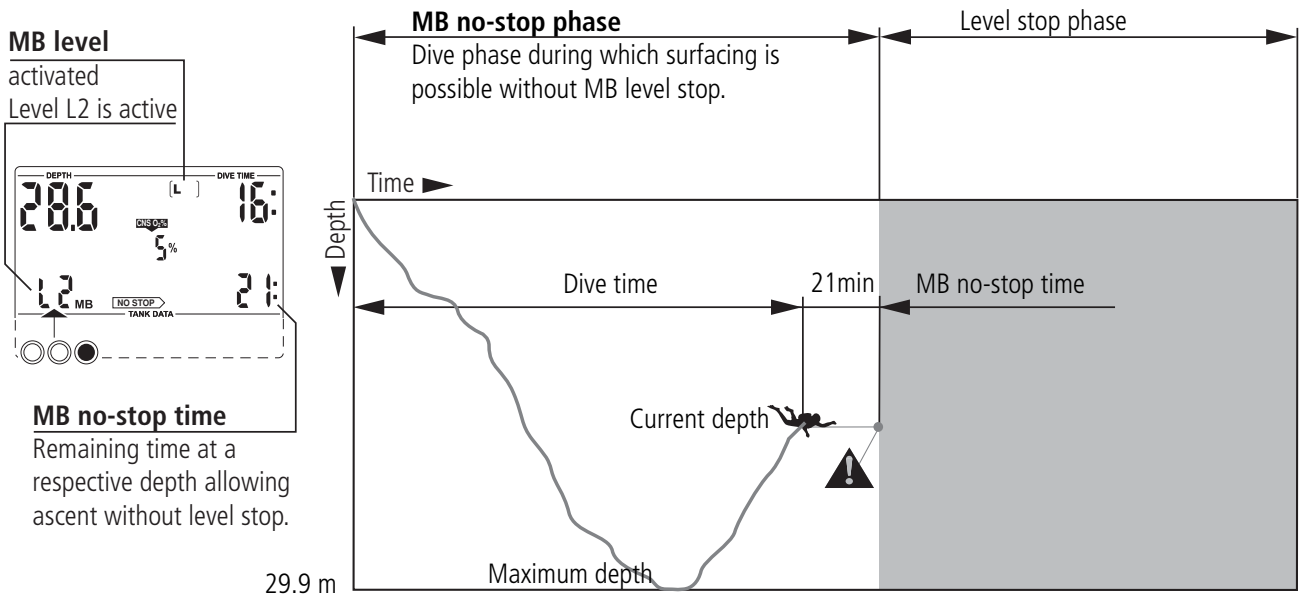

English

2.2 Display during level stop phase

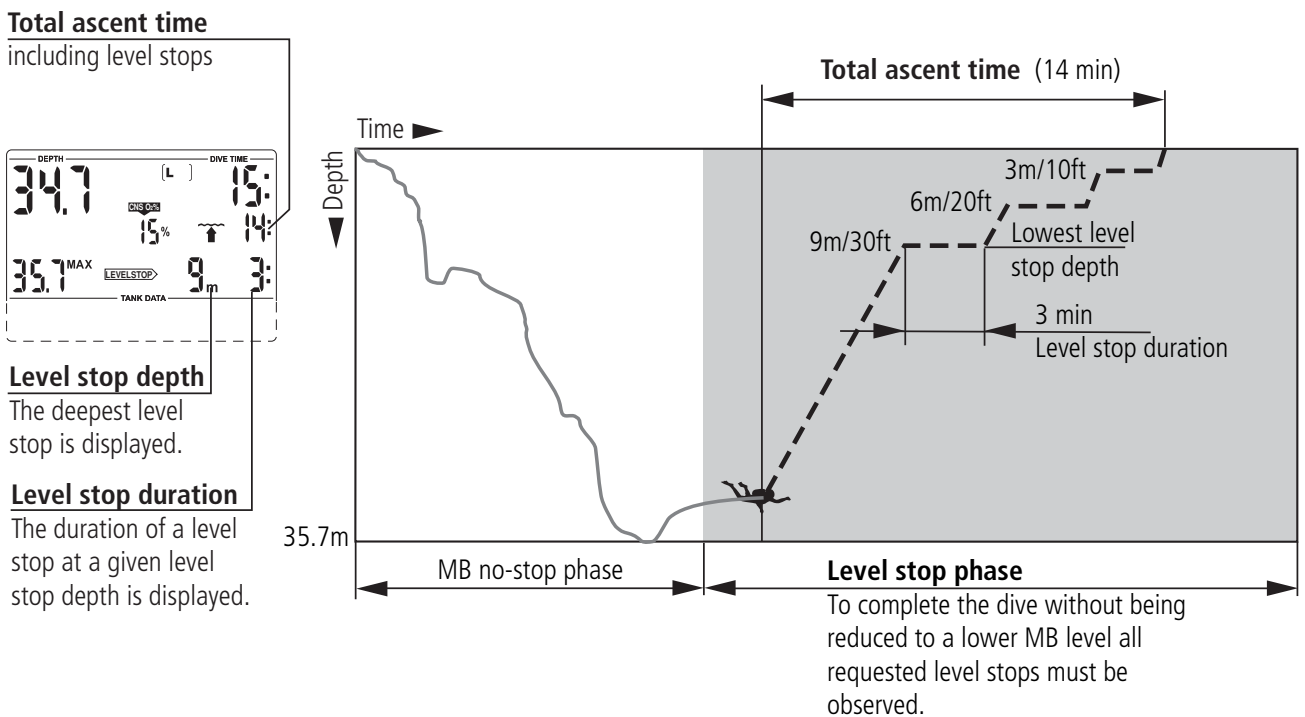

### 3 Preparation for a dive with microbubble levels (MB levels)

#### 3.1 Setting the MB level

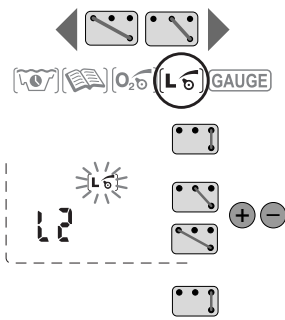

To change the MB level TEC must be in user mode.

1. Bridge contacts B and + or B and – until the symbol for MB levels appears.
2. Confirm that you wish to change the displayed MB level by bridging B and E.
3. Change MB level by bridging contacts B and + or B and – .
4. Confirm with B and E the selected MB level.

Without confirmation the display will disappear after 3 minutes and your entries will not be accepted.

TEC will display the [L] symbol to confirm that an MB level beyond L0 (L1-L5) has been chosen. During the dive the MB level is shown by pressing briefly ○○○. If however a level stop is ignored, the new MB level is permanently shown (->31).

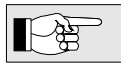

MB levels have an influence on the dive planner.

### 4 Functions during the dive with microbubble levels

#### 4.1 Level stop information

##### Microbubble (MB) no-stop time

While diving with MB levels L1 to L5 TEC will display the MB no-stop time instead of the ordinary no-stop time. Within the MB no-stop time no level stops are required.

The arrow [NO STOP] and the MB level symbol [L] are visible. The remaining MB no-stop time is shown in minutes.

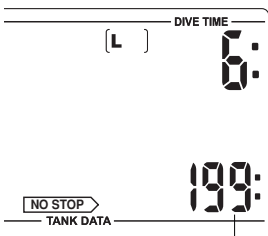

MB no-stop time

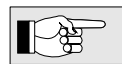

- Information and alarms for MB no-stop time and ordinary no-stop time are the same (->22).
- Regardless of the MB level, we generally recommend to perform a slow ascent during the last few metres / feet.

##### Level stop

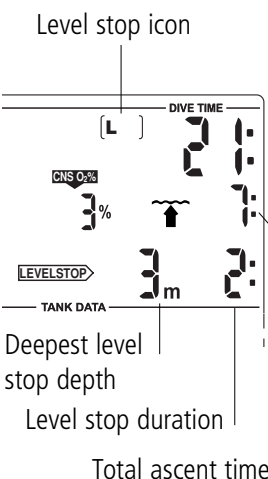

Level stop icon

Deepest level stop depth

Level stop duration

Total ascent time

On entering the level stop phase, the arrow [NO STOP] disappears and the arrow [LEVELSTOP] appears. The [LEVELSTOP] arrow flashes for 8 seconds and an audible attention beep goes off. To complete the dive without being reduced to a lower MB level, all requested level stops must be observed.

To the right of the [LEVELSTOP] arrow, the deepest level stop is displayed in metres/feet. The display <3m 2:> (<10ft 2:>) means that a level stop of 2 minutes at a depth of 3 metres (10ft) has to be observed.

When a level stop obligation is finished, the next higher level stop – if present – is displayed. When all level stops have been observed, the arrow [LEVELSTOP] extinguishes and the arrow [NO STOP] reappears. The indication of time shows the MB no-stop time again.

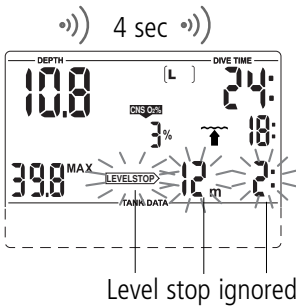

**WARNING** The attention message "Level stop ignored" is activated if the requested level stop is not observed. An attention beep\* goes off, the arrow **LEVELSTOP**, the depth and duration of the ignored level stop begin flashing.

To complete the dive without being reduced to a lower MB level, you must descend to the prescribed depth immediately!

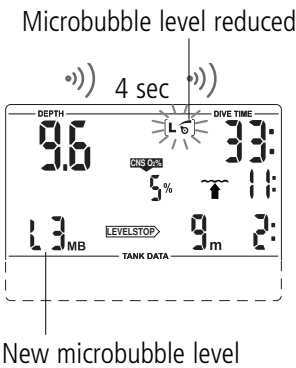

**WARNING** The warning "microbubble level reduced" is activated if the diver ascends more than 1.5m (5ft) above the required level stop. TEC reduces the microbubble level, an attention beep\* goes off and for the rest of the dive the new MB level is indicated in the position of the maximum depth. The level stop for the reduced MB level is now displayed.

To complete the dive without being further reduced to an even lower MB level the new level stop must be observed.

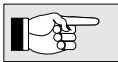

\* Attention beeps can be suppressed via SmartTRAK.

4.2 Total time of ascent

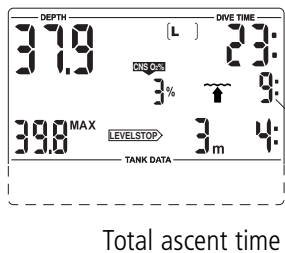

TEC displays the level stop information and the total time of ascent. This includes the time of ascent as well as all level stops.

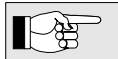

The total time of ascent is calculated on the basis of the prescribed ascent rate and a normal workload. Total time of ascent can be subject to change if the ascent rate is not ideal (100%) or if TEC detects a higher workload.

4.3 Decompression obligation

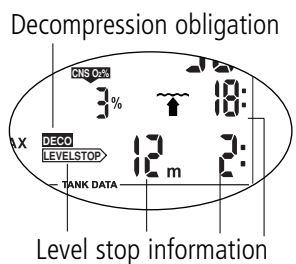

**WARNING** Avoid decompression dives when diving with MB levels.

TEC calculates and displays level stops to reduce microbubble formation, but it also calculates the diver's decompression data. If decompression stops become obligatory, the **DECO** symbol will be displayed. The total ascent time will now also contain a decompression stop.

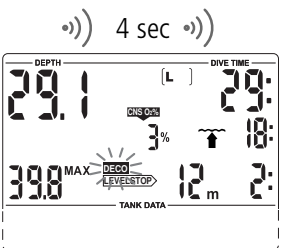

**WARNING** You are close to entering decompression: At the beginning of a decompression phase an attention beep goes off and the **DECO** symbol flashes for 8 seconds.

In order to prevent a dive with long decompression stops it is recommended that you ascend a few metres/feet on seeing this message.

## 4 Functions during the dive with microbubble levels

### 4.4 Level stop and deco stop

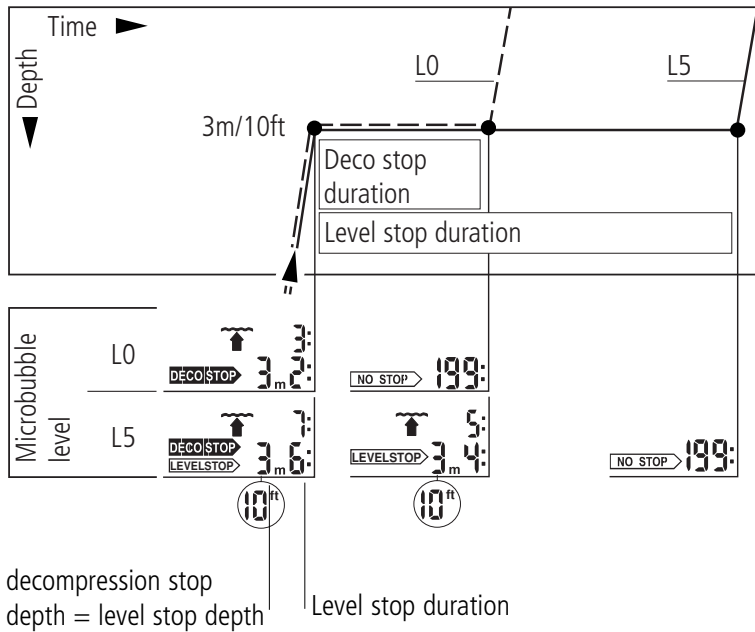

When the level stop depth equals the depth of the first obligatory decompression stop and if you are within 1.5m/5feet of the stop depth itself, TEC shows **DECO STOP** and **LEVEL STOP**. The indicated duration refers to level stop duration.

Since level stops are more restrictive than decompression stops, when all decompression obligations have been observed the display changes from **DECO STOP** **LEVEL STOP** to **LEVEL STOP** only.

### 5 Complete a dive with MB levels

A dive with MB levels is completed the same way as a dive without MB levels (L0) (-> 24), save for the following exceptions:

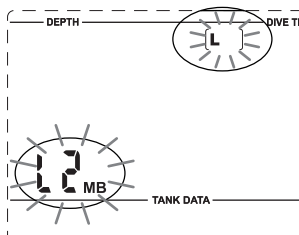

If the MB level has been reduced during the dive, TEC will display a flashing MB level symbol and the current MB level for five minutes after reaching the surface. The dive is then completed and TEC changes to user mode with the MB level switching back to the original MB setting.

Repetitive dives and microbubble levels: If during a dive a level stop is being ignored and the diver starts another descent shortly afterwards, TEC might immediately request level stops. To complete the dive with the initially set MB level all level stops must be observed.

## VI Diving with more than one gas mixture

VI



The following chapter deals with the characteristics of diving with more than one gas mixture.

Smart TEC enables you to use up to three different gas mixtures during the same dive. To measure the tank pressure, each tank requires an individual transmitter. Tank 1 contains the bottom mix, tank 2 contains the travel mix and tank D contains the deco mix. For dives with a single gas mixture you must use tank 1, for dives with 2 gas mixtures you must use tanks 1 and D.

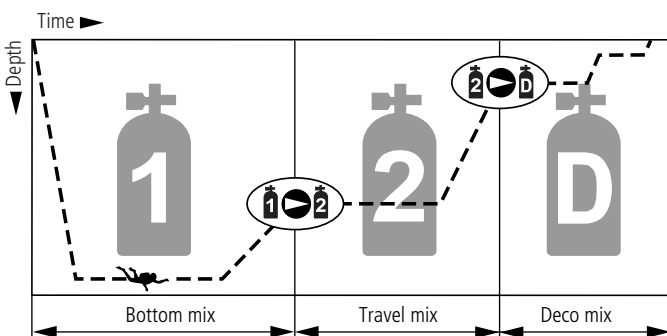

Diving with 3 gas mixtures

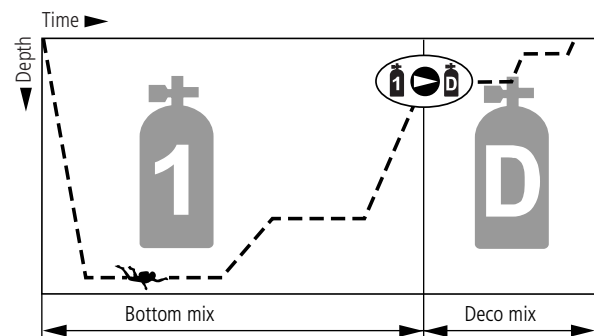

Diving with 2 gas mixtures

**Preparation for a dive with several gas mixtures**

Before the dive, all transmitters in use must be paired with TEC, the fraction of oxygen must be entered for each tank and the depth for changing the gas mixture must be set for tanks 2 and D.

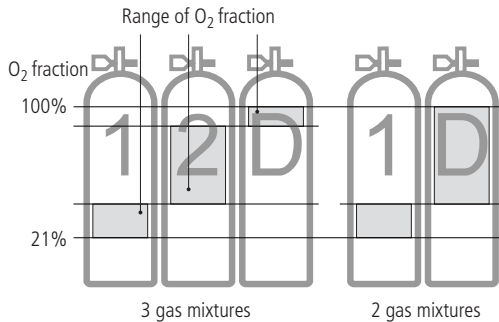

**Setting the gas mixture and the depth for changing the gas mixture** 

During dives with more than one gas mixture the bottom mix (tank 1) contains the lowest fraction of oxygen, while the deco mix (tank D) contains the highest fraction. The additional travel mix (tank 2) for dives with 3 gas mixtures holds a fraction of oxygen that is between that of tank 1 and tank D. TEC will only accept settings corresponding with this order. Note however that you can also set 2 or even 3 tanks to the same gas mixture. TEC will only accept gas mixture switching depths (MOD) as input where the maximum partial pressure of oxygen (ppO<sub>2</sub>), as pre-set manually (-> 18 point 6) or by means of SmartTRAK, is not exceeded.



For gas mixtures having an oxygen percentage of 80% or greater the ppO<sub>2</sub> is fixed at 1.6bar and cannot be altered in any way.

Procedure:

1.  Enter the setting for the fraction of oxygen and the MOD for tank 1 (bottom mix) according to the instructions on page 18 (points 1-7).
2.  Enter the setting for the fraction of oxygen for tank D (deco mix) according to the instructions on page 18 (points 1-5).
3.  By bridging B and + or B and - enter the desired depth at which you will change to tank D during the ascent phase. Confirm your settings with B and E.



The depth you have selected is the Maximum Operating Depth (MOD) for this gas mixture and the indicated ppO<sub>2</sub> becomes the maximum tolerable partial pressure of oxygen (ppO<sub>2 max</sub>). During the ascent an audible attention message will indicate that you have reached the depth which requires the change of your gas mixture. This applies to tanks D and 2 (see points below).

4.  For dives with three gas mixtures enter the setting for the fraction of oxygen for tank 2 (travel mix) according to the instructions on page 18 (points 1-5).



Note that tank symbol 2 can only be selected after tank symbol D has been assigned to a gas mixture.

5.  Now enter the maximum depth for the use of tank 2 by bridging B and + or B and -. Confirm your settings with B and E. The information given under point 3. does apply here also.



Without confirmation with B and E the display will disappear after 3 minutes and your entries will not be accepted.

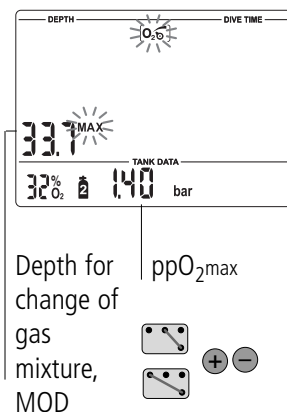

The time to reset the O<sub>2</sub>% mix to air can be set with SmartTRAK between 1 hour and 48 hours or to "no reset" (default).

After the reset, the oxygen fraction of tank 1 is set to 21%, tanks 2 and D are switched off (- - %O<sub>2</sub>).

### Switching off gas mixtures

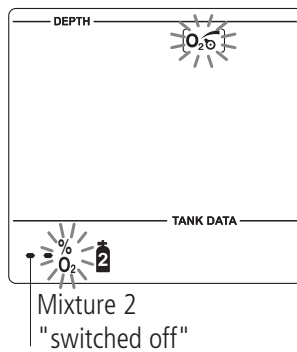

Tanks which are not going to be used during the next dive (even though their fraction of oxygen has been defined) must be "switched off". This is achieved by switching off the appropriate gas mixture at TEC.

Gas mixtures which have been switched off cannot be selected during the dive and TEC will ignore their transmitters.

Tank 1 cannot be switched off. If tank D (deco mix) is switched off, tank 2 will automatically be switched off as well.

Procedure:

1. Select the tank symbol of the gas mixture you wish to switch off and the setting of the O<sub>2</sub> mix, according to the instructions on page 18 (points 1-3).
2. Reduce the fraction of oxygen with B and –, until "-- %O<sub>2</sub>" appears.
3. Confirm your settings with B and E.

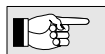

The pairing of transmitter and tank symbol will remain valid even if the gas mixture has been shut off.

The selected depth for the change of gas mixture (MOD) is deleted once the gas mixture is switched off.

### Functions during a dive with several gas mixtures



Diving with more than one gas mixture represents a much higher risk (than diving with a single mixture), and mistakes by the diver may lead to serious injury or death.

During dives with several gas mixtures, always make sure you are breathing from the tank you intended to breath from.

Mark all your tanks and regulators, so they can under no circumstances be mixed up! Before every dive and after changing a tank, make sure that each gas mixture is set to the correct value for the corresponding tank.

### Decompression prognosis

The calculation of decompression data (e.g. the total time of ascent) is based on the assumption that changes of gas mixture will be performed at the previously selected depths (MOD gas mixture 2, MOD gas mixture D). If a diver ignores a required change or changes the mixture belatedly, TEC will readjust the decompression calculation accordingly. The dive computer will then base its calculations on the assumption that the diver will either use the indicated gas mixture until he/she reaches the depth for the next change or – if no further changes are planned – that he/she will ascend to the surface with the current mixture.

### Remaining Bottom Time

In addition to calculating the decompression prognosis for all the activated tanks, in the background TEC also calculates the decompression prognosis for tank 1 by itself, and (when diving with three tanks) for tanks 1+2 only and for tanks 1+D only. The Remaining Bottom Time (RBT) while breathing from tank 1 considers that you will finish the dive with tank 1, using the decompression prognosis for tank 1 alone. The RBT while breathing from tank 2 considers that you will finish the dive with tank 2 using the decompression prognosis for tanks 1 and 2 only (see -> 35, 36). This allows, when starting the ascent before RBT=0, to always be able to finish a dive if by accident you were to lose the travel and/or deco bottles, find that they are empty or in case of regulator malfunction. Note that for any tank (1, 2 or D) when you are shallower than 6m/20ft the RBT indicates the duration of the gas supply (minus the reserve) at the current depth.

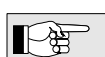

Since TEC needs to evaluate your breathing pattern and the corresponding pressure drop in the tank, it takes about 2 minutes after you start breathing from a tank before TEC shows the RBT.

**Changing the gas mixture**

After immersion, TEC automatically selects gas mixture 1.

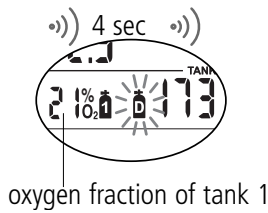

If during the ascent a diver reaches the depth requiring a change of gas mixture (MOD gas mixture D or 2), the imminent change is brought to the diver's attention by an audible attention signal and the flashing of the tank symbol of the new gas mixture, both lasting for 30 seconds.

Procedure:

- switch to the regulator with the new gas mixture and start breathing
- confirm the change by pressing and holding  (long beep) within 30 seconds. The tank symbol will stop flashing.

**No change of gas mixture:**

If a diver fails to confirm the change of gas mixture, TEC will continue to calculate with the previous gas mixture and adapt the decompression calculation accordingly.

**Belated change of gas mixture:**

A diver can catch up on a required change of gas mixture until he reaches the surface. By quickly pressing  the tank symbol of the new gas mixture will start flashing.

Switch to the regulator with the new gas mixture and start breathing. Confirm the change by pressing and holding . The tank symbol will stop flashing and the decompression calculation will readjust accordingly.

**Submerging again after a change of gas mixture:**

If after a change of gas mixture the Maximum Operating Depth (MOD) of the current mixture is exceeded, the  $ppO_2$  max warning will appear. ->20 Change to the gas mixture suited for this depth and select the appropriate tank symbol or rise to the Maximum Operating Depth of the current gas mixture. Failure to do so can result in oxygen poisoning.

**Examples for clarification of RBT and change of gas mixtures**

The following figures show a dive profile and the display of various TECs in the following settings:

**TEC-1:** set to 21% (tank 1)

**TEC-3:** set to 21% (tank 1) and 100% (tank D)

**TEC-2:** set to 21% (tank 1) and 50% (tank D)

**TEC-4:** set to 21% (tank 1), 50% (tank 2) and 100% (tank D)

- 1. Start of ascent:** the TECs have different decompression prognosis, indicating the benefit of the travel and/or decompression gases. However, the RBT is the same for all four, as it relates to tank 1 only. It indicates that starting the ascent within the next three minutes the diver will have enough gas for the ascent and the decompression obligations shown on TEC-1. At RBT=3 or less, the ascent arrow is showing: TEC suggests that the diver starts the ascent.
- 2. Slightly below MOD for 50% mix (MOD=22m):** The slow ascent has caused significant build-up of decompression obligations. There is a marked difference in ascent times, indicating the benefit of decompressing at high oxygen percentage.
- 3. Above MOD for 50%, missed switch:** TEC-2 adjusts its decompression prognosis to be same as TEC-1. TEC-4 adjusts its decompression prognosis to be the same as TEC-3.
- 4. Again below MOD for 50%:** TEC-2 and TEC-4 once again show credit for the presence of the 50% mix in their calculations.
- 5. Above MOD for 50%, switch carried out:** TEC-2 and TEC-4 show the tank pressure in the 50% tank. The RBT agrees because also in TEC-4 it considers the 50% tank will be used to finish the dive. TEC-1 and TEC-3 are not receiving any signals from the transmitter on the 21% tank and show "- - -".
- 6. Slightly below the MOD for 100% mix (MOD=6m):** During the slow ascent from 22m, TEC-2 using 50% oxygen has caught up on the decompression schedule of TEC-3, which is still using 21% oxygen but gives credit for the upcoming switch to 100% oxygen.



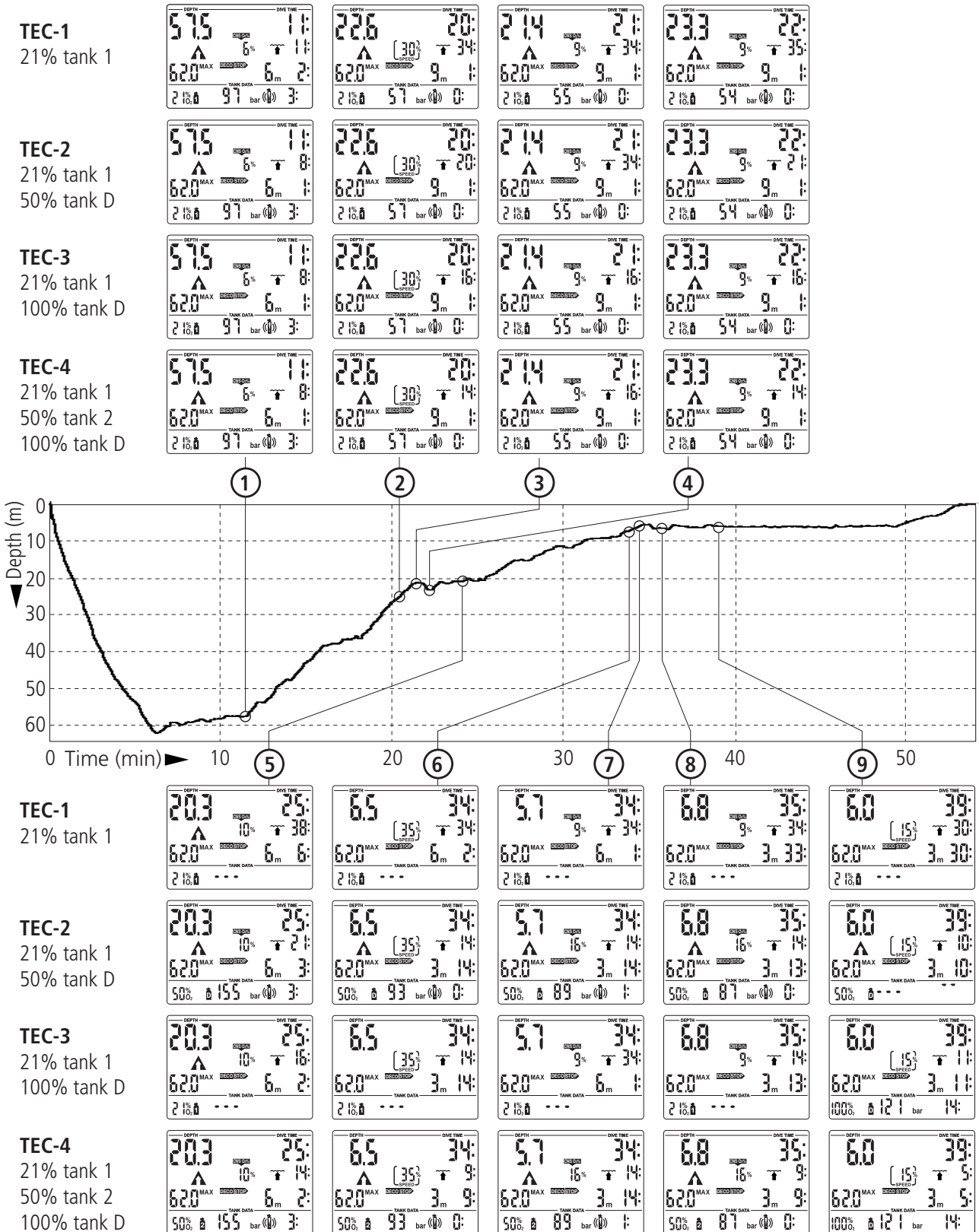

## VI Diving with more than one gas mixture

- 7. Above MOD for 100%, missed switch:** now TEC-3 gives the same decompression prognosis as TEC-1. TEC-4 gives the same decompression prognosis as TEC-2.
- 8. Again below the MOD for 100%:** TEC-3 and TEC-4 again show credit for the presence of the 100% mix in their calculations
- 9. Above MOD for 100%, switch carried out:** TEC-3 and TEC-4 show the tank pressure in the 100% tank. The RBT agrees. TEC-2 is not receiving anymore signals from the 50% tank and shows " - - - ". However, the slow ascent and delayed switch to 100% has caused the decompression prognosis to be shorter on TEC-2 than TEC-3.





 TEC has a dive planner which allows the planning of no-stop dives as well as decompression dives with freely determinable surface intervals and with up to three different gas mixtures.

- Basis of the planning:
- selected fraction of oxygen and MOD of all active gas mixtures
  - selected microbubble level
  - water temperature of the most recent dive
  - altitude range (if any)
  - status of saturation at the time the dive planner is selected
  - assuming a normal workload of the diver and observance of the prescribed ascent rates
  -  assumption: changes of gas mixture are performed at the selected MOD of mixtures 2 and D.





**WARNING**

If two or more divers using computers are planning a dive, planning for all divers has to be based on the dive computer showing the shortest no-stop times. Failure to do this may lead to serious injury or death from decompression sickness.

Before using the dive planner, the fraction of oxygen must be entered for each required tank and the depths for a change of gas mixture for tanks 2 and D must be entered. Tanks, i.e. gas mixtures which are not going to be used during the next dive must be switched off (->33-34). All 'activated' gas mixtures will be indicated by their tank symbols and allowed for calculation.

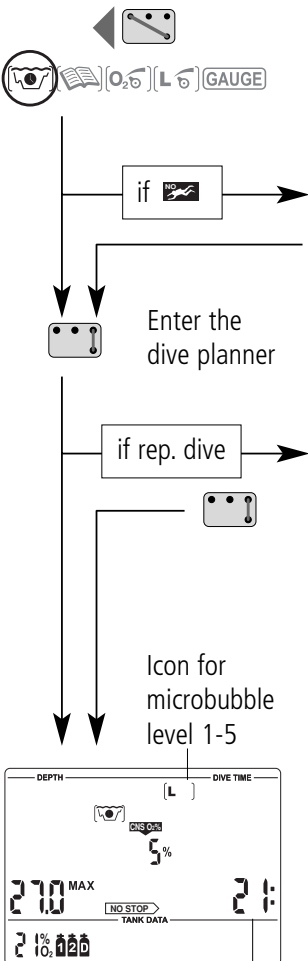
### 1 Planning a no-stop dive



The flowchart starts with a 'Dive planner icon' (a diver with a computer). It branches into two paths: 'if ' leading to a 'Dive planner icon' screen showing '3h 07:' and 'Microbubble warning (Do Not Dive)'; and 'Enter the dive planner' leading to an 'if rep. dive' screen showing 'Int 3h 15:'. Both paths lead to a final screen showing 'No-stop time or MB no-stop time' with '270 MAX' and '21:'. A note indicates that the 'if rep. dive' path also involves 'Input of the surface interval' using '+' and '-' buttons.

With the contacts B and – or B and + you can select the dive planner at the surface. (The dive planner cannot be selected in gauge mode)

 The microbubble warning and its duration are displayed if TEC detects an increased risk due to the accumulation of microbubbles.

Enter the dive planner with B and E.

The input window for the time interval is displayed if there was a remaining desaturation (DESAT) before the Dive Planner has been selected. This surface interval between now and the beginning of the dive can be changed with the contacts + and – in steps of 15 minutes.

 If a microbubble warning (no dive) and its duration has been displayed, TEC proposes this time – rounded up to the next 15 minutes – as surface interval. If the proposed interval is shortened, the microbubble warning appears.

With B and E you confirm the displayed interval (if applicable), then TEC starts scrolling the no-stop times. The no-stop times are displayed in 3 metre increments (10 ft) and are displayed for every increment for about 2 seconds. The process starts at 3 metres (10 ft).

 If a microbubble level has been selected (L1-5), the MB no-stop time is shown.

No-stop times will be displayed as long as the selected maximum operating depth (MOD) of tank 1 is not exceeded.

 On page 24 you will find further information and safety considerations regarding the microbubble warning.

## 2 Planning a decompression dive

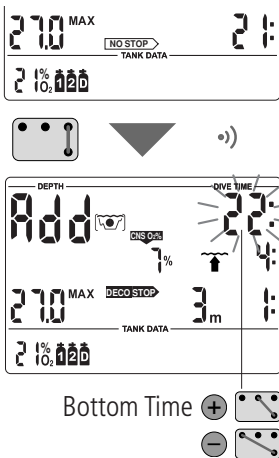

1. Activate the dive planner for a no-stop dive ->37.
2. Wait until the desired depth appears, then switch into decompression planning by bridging contacts B and E. TEC shows the bottom time (no-stop time + 1 minute) and the appropriate decompression information or level stop data respectively.
3. <Add> asks that you set the bottom time. This is done with contacts B and +, B and – respectively. As soon as the contacts are no longer bridged, TEC calculates the decompression information or level stop data respectively for this set bottom time.

If you wish to plan a decompression dive at another depth, switch from decompression planning to no-stop planning by means of B and E. TEC again shows the scrolling no-stop times. Now you can switch between no-stop planning and decompression planning at will with contacts B and E.

If the calculated decompression information and the total ascent time exceed 199 minutes, or the CNS O<sub>2</sub> % value exceeds 199%, the said values will start flashing on the display or <– → values appear and the decompression calculation is suspended until the bottom time has been reduced accordingly. CNS O<sub>2</sub>% values higher than 199% will be displayed as 199 %.

## 3 Leaving the dive planner

With the contacts B and E (1-2 sec) you can exit the Dive Planner. This also occurs after three minutes without operation.

1 Survey

A dive is entered in the logbook if the dive time is longer than 2 minutes. TEC records the profiles of about 100 hours of diving. This information can be transferred to a PC with the standard infrared interface (IrDA) and the Windows® software SmartTRAK. Up to 99 dives can be displayed directly on the dive computer.

The following information of the dive is displayed:

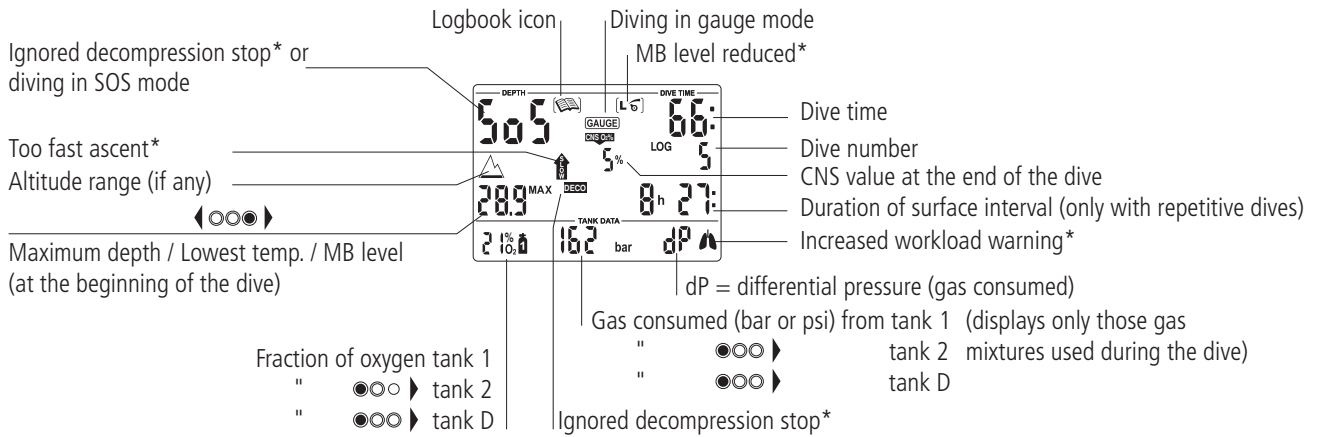

\*Alarms during the dive

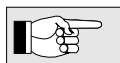

If a dive is started within adaptation time (after a change of altitude), the adaptation time is displayed instead of the surface interval.

2 Operation

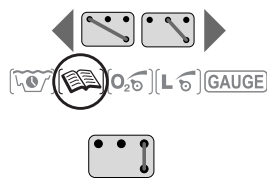

With the contacts B and + or B and – you can select the logbook. With B and E you enter the logbook.

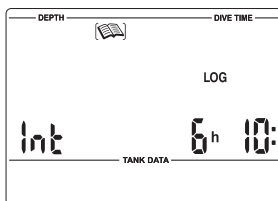

If there was a remaining desaturation time (DESAT) before selecting the logbook, the time since the last dive (surface interval) is displayed.



With B and E you get the most recent dive displayed (LOG 1).

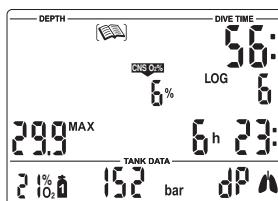

Each bridging of B and + or B and – causes a jump to the next older or more recent dive. Upon continuous bridging of the contacts all dives are displayed successively.

With the contacts B and E you can exit the logbook. The logbook closes automatically after 3 minutes without operation.

## IX Appendix

### 1 Technical information

- Operating altitude:** with decompression information: sea level up to approx. 4000 m (13120ft);  
w/o decompression, w/o RBT information: usable in gauge mode (at any altitude)
- Max. displayed depth:** 120m (395 ft), resolution between 0.8 m and 99.9 m: 0.1 m, >99.9 m: 1m  
The resolution in feet is always 1 foot



#### WARNING

- Do not dive deeper than the limits given by the chosen fraction of oxygen (nitrogen narcosis, oxygen toxicity).
- Never dive deeper than your training qualification (experience) allows you.
- Always observe local dive depth restrictions.

**Decompression calculation depth range:** 0.8 to 120m (3 to 395 ft)

**Maximum environment pressure:** 13 bar (189 psi)

**Clock:** Quartz timer, display up to 999 minutes.

**O<sub>2</sub>% Mix:** Adjustable between 21%O<sub>2</sub> (compressed air) and 100% O<sub>2</sub>

**Operating temperature:** -10° to +50°C (14°F to 122°F).

**Power supply:** Special battery UWATEC LR07

**Life of the battery:** 500 to 800 dives, depending on the quantity of dives per year and the use of the backlight.

**Transmitter:** **High pressure connection:** Maximum working pressure: 300 bar (4350 psi)  
**Life of the battery:** up to 1000 dives, max. 3 years without use.  
**Power supply:** User replaceable battery CR2450

### 2 Maintenance

The tank pressure gauge and the parts of this product used to measure the tank pressure should be serviced by an authorized SCUBAPRO UWATEC dealer every second year or after 200 dives (whichever comes first). Aside from that your TEC is virtually maintenance free. All you need to do is to rinse it carefully with fresh water after each use and to have the batteries changed when needed. To avoid possible problems with your TEC, the following recommendations will help assure that it will give you years of trouble free service:



#### WARNING

- Avoid dropping or jarring your TEC.
- Do not allow your TEC to be exposed to direct, intense sunlight.
- Rinse your TEC thoroughly with fresh water after each dive.
- Do not store your TEC in a sealed container; make sure there is free ventilation.
- If there are problems with operating the contacts, use soapy water to clean TEC and dry it thoroughly. The surface of your TEC housing can be treated with silicone grease. Do not apply grease to the water contacts!
- Do not clean TEC with liquids containing solvent (apart from water).
- If the service icon appears, TEC must not be used for any further dives. Take your dive computer to an authorized SCUBAPRO UWATEC dealer.



#### WARNING

Take the dive computer to an authorised SCUBAPRO UWATEC dealer in order to change the batteries. The battery replacement is carried out by a SCUBAPRO UWATEC subsidiary. TEC is checked for its technical integrity at the same time. Do not attempt to have the batteries changed by anyone other than an authorised SCUBAPRO UWATEC dealer.

#### 2.1 Replacing the battery of the transmitter



#### WARNING

It is recommended to have the battery of the transmitter replaced by an authorized SCUBAPRO UWATEC dealer. The change must be made with particular care in order to prevent water from seeping in. The warranty does not cover damages due to an improper replacement of the battery.

**Transmitter battery set (PN 06.201.920):** Includes a Type CR 2450 battery and a 26.00 x 2.00 mm transmitter cap o-ring .

**WARNING**

Never touch the metal surface of the battery with bare fingers. The two battery poles must never be short circuited.

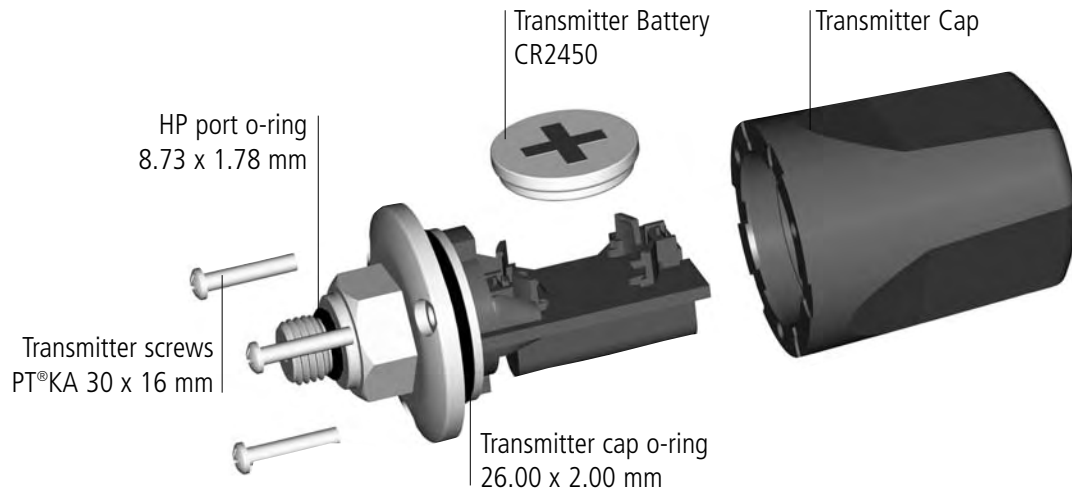
**Procedure:**

To replace the battery you need a Phillips screwdriver and a clean cloth.

**WARNING**

- A leaking transmitter cap may lead to the destruction of the transmitter by water seeping in or cause the transmitter to switch off without prior notice.
- Always open the transmitter in a dry and clean environment.
- Only open the transmitter to replace the battery.

1. Remove the transmitter from the HP outlet of the first stage of the regulator.
2. Dry the transmitter with a soft towel.
3. Remove the 3 screws with the Phillips screwdriver.
4. Remove the transmitter cap carefully.
5. Remove the transmitter cap o-ring carefully. Do not damage the sealing surfaces.
6. Remove the battery by holding it on both sides. Do not touch the contacts or electronic parts.

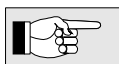

Protect the environment and dispose the battery properly.

**WARNING**

If you notice traces of seeping water, damages, or other defects on the o-ring, do not use the transmitter for further dives. Take it to an authorized SCUBA-PRO UWATEC dealer for check and repair.

7. Always insert a new o-ring when you replace the battery and dispose the old o-ring. Make sure that the new, lubricated o-ring is in perfect condition, and that o-ring, o-ring groove and the sealing surfaces of HP outlet and transmitter cap are free of dust and dirt. If necessary, clean the parts with a soft cloth. Fit the o-ring in the o-ring groove.

**WARNING**

8. Check the proper polarity of the battery. The transmitter can be damaged if you do not insert the battery correctly.

Wait for at least 30 seconds. Now insert the new battery, with "+" pointing upwards, into the battery compartment.

9. After battery replacement the transmitter will perform an automatic test and switch into ready mode after 60 seconds.



10. The transmitter cap will only fit in *one* position. Check the proper position of the guide slots on the electronic support and in the transmitter cap.

Slide the transmitter cap carefully back into its proper position.

11. Do not overtighten the screws! Fasten the transmitter cap with the 3 screws.  
 12. Mount the transmitter on the HP outlet of the first stage of the regulator and check transmission and pairing. If you do not receive valid tank pressure data, transmitter and dive computer must be paired again.

### 3 Conversion of tank pressure

Tank pressure indicated may differ from the information given by a manometer/pressure gauge. TEC displays pressure always converted to a temperature of 20°C / 68°F, whereas the mechanical pressure gauge displays the current pressure influenced by temperature.

The figure below allows you to compare the information given by a conventional pressure gauge and by TEC at six different temperatures.

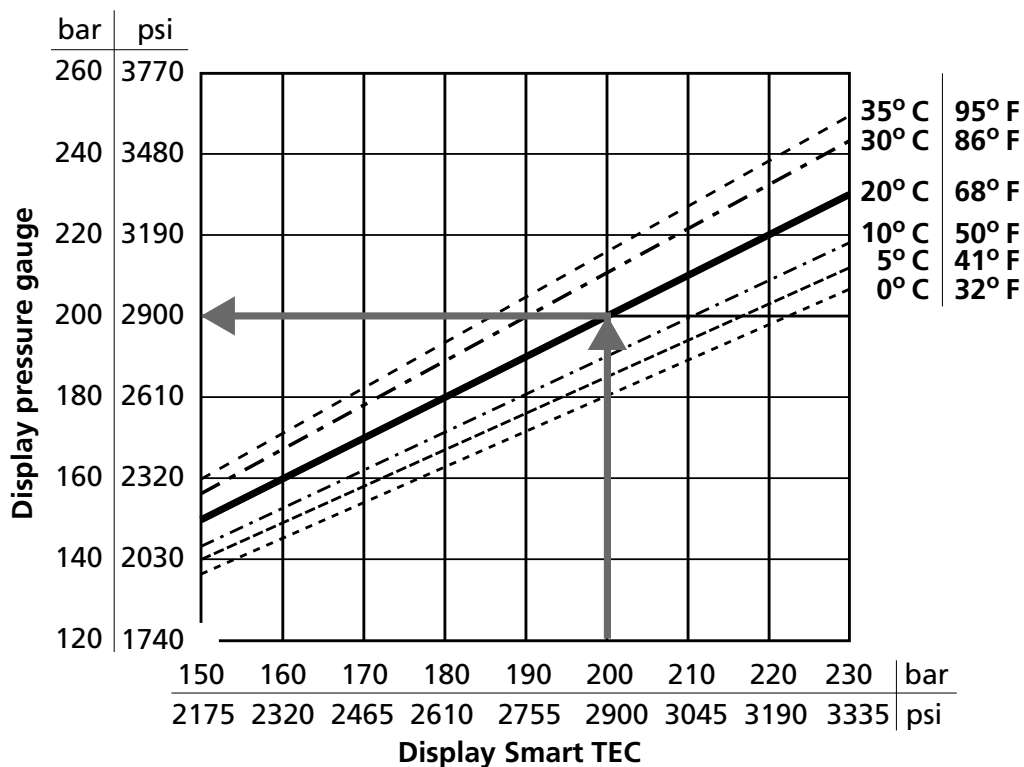

### 4 Warranty

The warranty only covers dive computers which have been bought from an authorised SCUBAPRO UWATEC retailer.

The warranty is given for a period of 2 years.

Repairs or replacements during the warranty period do not increase the warranty period.

In order to put forward a warranty claim: send the dive computer together with a dated receipt of the purchase to your authorised retailer or an authorised servicing point.

UWATEC reserves the right to determine the merits of a warranty claim and to determine whether the computer will be repaired or replaced.

Excluded are faults or defects due to:

- excessive wear and tear;
- exterior influences, e.g. transport damage, damage due to bumping and hitting, influences of weather or other natural phenomena;
- servicing, repairs or the opening of the dive computer by anybody not authorised by the manufacturer. This especially concerns the change of battery;
- pressure tests which do not take place in water;
- diving accidents;
- improper placement of the transmitter cap.

## 5 FCC

This device complies with part 15 of the FCC Rules. Operation is subject to the following two conditions: (1) This device may not cause harmful interference, and (2) this device must accept any interference received, including interference that may cause undesired operation.

## 6 Index

Active backlight	11	No-stop time	15, 22, 28
Ascent rate	15, 17, 19	O <sub>2</sub> % mix, Set up...	18
Battery alarm	17	O <sub>2</sub> fraction	15, 16, 18
Battery capacity, Checking the...	10	O <sub>2</sub> partial pressure	16, 17, 20
Battery lifetime	40	O <sub>2</sub> partial pressure, maximum	16, 20
Beep, Switch off the...	17	O <sub>2</sub> toxicity	15, 16, 17, 21, 39
Changing the gas mixture	26, 34	Operating TEC	4, 8, 9
CNS O <sub>2</sub>	2, 3, 15, 16, 17, 21, 39	Oxygen..., see "O <sub>2</sub> ..."	
Deco data during decompression phase	15	PC, transfer to PC (logbook)	39
Deco data during no-stop phase	15	ppO <sub>2</sub> , see O <sub>2</sub> partial pressure	
Decompression stop, Ignored...	17, 23	Premix, setting the gas mixture	18
Depth, current	19	RBT	15, 17, 22
Desaturation time	24	Safety stop timer	23
Dive	15	Setting the MOD	18, 33
Dive planner	37	SmartTRAK	8, 9, 16, 17, 39
Dive time	19	SOS mode	11
Dive, end of a dive	24	Stopwatch	27
Fly, "no-fly time"	10, 24	Surface interval	37, 39
Gas mixture, Setting...	18	Switching off gas mixtures	34
Gauge mode	26	System	8
Light	11	Tank pressure	21
Logbook	39	Technical information	40
Maintenance	40	Transmitter	8, 12, 40
Maximum depth	19, 39	Warnings	17
Microbubbles	28	Workload	21
Microbubbles, Warning of...	24, 37	Workload, Increased...	21
Mountain lakes, Diving in...	25, 39		
Mounting the transmitter to the first stage	12		
Nitrox	16		

**SCUBAPRO UWATEC Americas**

(USA/Canada/Latin America)

1166 Fesler Street  
El Cajon, CA 92020 USA  
t: +1 619 402 1023  
f: +1 619 402 1554  
www.scubapro.com

**SCUBAPRO UWATEC Asia Pacific**

1208 Block A, MP Industrial Center  
18 Ka Yip St.  
Chai Wan Hong Kong  
t: +852 2556 7338  
f: +852 2898 9872  
www.scubaproasiapacific.com

**SCUBAPRO UWATEC Australia**

Unit 21, 380 Eastern Valley Way  
Chatswood, N.S.W. 2067  
t: +61 2 9417 1011  
f: +61 2 9417 1044  
www.scubapro.com.au

**SCUBAPRO UWATEC Deutschland**

(Germany / Austria / Scandinavia)  
Taucherausrüstungen GmbH  
Rheinvogtstraße 17  
79713 Bad Säckingen-Wallbach  
t: +49 (0) 7761 921050  
f: +49 (0) 7761 921051  
www.scubapro.de

**SCUBAPRO UWATEC Italy**

Via G.Latiro 45  
I-16039 Sestri Levante (GE)  
t: +39 0185 482 321  
f: +39 0185 459 122  
www.scubapro.it

**SCUBAPRO UWATEC Japan**

4-2 Marina Plaza 5F  
Kanazawa-Ku  
Yokohama  
Japan  
t: +81 45 775 2288  
f: +81 45 775 4420  
www.scubapro.co.jp

**SCUBAPRO UWATEC France**

Les Terriers Nord  
175 Allée Belle Vue  
F-06600 Antibes  
t: +33 (0) 4 92 91 30 30  
f: +33 (0) 4 92 91 30 31  
www.scubapro-uwatec.com

**SCUBAPRO UWATEC Benelux**

Avenue des Arts, 10/11 Bte 13  
1210 Bruxelles  
t: +32 (0) 2 250 37 10  
f: +32 (0) 2 250 37 11  
www.scubapro-uwatec.com

**SCUBAPRO UWATEC España**

Pere IV, nº359, 2º  
08020- Barcelona  
t: +34 93 303 55 50  
f: +34 93 266 45 05  
www.scubapro-uwatec.com

**SCUBAPRO UWATEC U.K.**

Vickers Business Centre  
Priestley Road  
Basingstoke, Hampshire RG24 9NP  
England  
t: +44 0 1256 812 636  
f: +44 0 1256 812 646  
www.scubapro.co.uk

**SCUBAPRO UWATEC Switzerland**

Oberwilerstrasse 16  
CH-8444 Henggart  
t: +41 (0) 52 3 16 27 21  
f: +41 (0) 52 3 16 28 67  
www.scubapro.de

**www.uwatec.com**



# Operating Manual

Deutsch

English

Français



*Smart 2*

**UWATEC**<sup>®</sup>

SWISS MADE BY UWATEC AG

You must carefully read and understand this entire manual before using your new computer.



Diving has many inherent risks. Even if you follow the instructions of this manual in a careful manner, it is still possible that you may be seriously injured or die from decompression sickness, oxygen toxicity or some other inherent risk of scuba with Nitrox or compressed air. Unless you are fully aware of these risks and are willing to personally accept and assume responsibility for those risks, do not use the computer!

### Guidelines for the use of your UWATEC dive computer:

The following guidelines are derived from the latest medical research and the recommendations of the American Academy of Underwater Sciences for diving with diving computers. Following these guidelines will greatly increase your safety while diving, but cannot guarantee that decompression sickness or oxygen toxicity will not occur.

- This computer is designed for dives with Nitrox (to a max. 100% O<sub>2</sub>) and compressed air (21% O<sub>2</sub>) only. Do not use the computer for dives made with other mixed gases.
- It is absolutely necessary to check the set mixture before each dive and to compare it to the gas mixture currently used. Always remember: setting an incorrect mixture carries an inherent risk of decompression sickness and/or oxygen toxicity! Maximum deviation from the measured mixture must not exceed 1% O<sub>2</sub>. An incorrect gas mixture can be lethal!
- Only use this computer with open circuit breathing systems. The computer must be set for a determined gas mixture.
- Only use this computer for diving with an independent breathing apparatus. The computer is not designed for long term exposures with Nitrox.
- Always observe the visual and audible alarm signals of the computer. Avoid situations of increased risk which are marked with a warning sign in this operating manual.
- If the ascent arrow appears, start to ascend. ▲
- If the flashing ascent arrow appears, start to ascend immediately. ▲
- This computer has a ppO<sub>2</sub> warning, the default limits of which are set at 1.4 bar ppO<sub>2</sub>max. This limit can be adjusted via SmartTRAK. An alteration of the ppO<sub>2</sub>max to higher than 1.6 bar is dangerous and we do not recommend this.
- Frequently check the "oxygen clock" (CNS O<sub>2</sub>), especially in the range higher than 1.4 bar ppO<sub>2</sub>. Ascend and finish the dive if the CNS O<sub>2</sub> exceeds 75%.
- Never dive deeper than the Maximum Operating Depth (MOD) pertinent to the gas mixture in use.
- Always check the diving limits considering the oxygen content and standard sports diving procedures (decompression sickness, oxygen toxicity).
- In accordance with the recommended maximum diving limit of all instructional agencies, do not dive deeper than 40 metres/130 feet.
- The danger of nitrogen narcosis has to be taken into consideration. The computer gives no warning about this.
- On all dives, with or without dive computer, make a safety stop for at least 3 minutes at 5 metres (15 feet).
- All divers using dive computers to plan dives and indicate or determine decompression status must use their own computer, which they take with them on all dives.
- If the computer fails at any time during the dive, the dive must be terminated, and appropriate surfacing procedures (including a slow ascent and a 3 to 5 minute safety stop at 5 metres /15 ft) should be initiated immediately.
- Comply with the ascent rate and carry out any decompression stop required. If the computer should fail for any reason, you must ascend at a rate of 10m (30 feet) per minute or less.
- On any given dive, both divers in a buddy pair must follow the most conservative dive computer for that particular dive.
- Never dive without a buddy. Smart Z does not substitute for a dive buddy.
- Only make dives that are appropriate to your level of dive training. A dive computer does not increase your knowledge of diving.

- Always dive with back-up instruments. Make sure that you always use back-up instrumentation including a depth gauge, submersible pressure gauge, digital bottom timer or dive watch, and have access to decompression tables whenever diving with a dive computer.
- Avoid repeated ascents and descents (yo yo diving).
- Avoid repeated heavy workload while at depth.
- Plan the dives to be shorter if they are made in cold water.
- After finishing the decompression or at the end of a no-stop dive, the final stage of the ascent should be as slow as possible.
- You MUST be familiar with all signs and symptoms of decompression sickness before using this computer! Seek IMMEDIATE treatment for decompression sickness should any of these signs or symptoms occur after a dive! There is a direct correlation between the effectiveness of treatment and the delay between the onset of symptoms and the treatment for decompression sickness.
- Only dive with Nitrox after you have been thoroughly instructed by a recognised institution.

**Repetitive dives**

- Do not start your next dive before your CNS O<sub>2</sub>% status has dropped below 40%.
- Diving with Nitrox: Make sure your surface interval is long enough (just like diving with compressed air). Plan for a minimum surface interval of two hours. Oxygen, too, needs sufficient time to leave the body.
- Match gas mixture to the intended dive.
- Do not attempt a repetitive dive if the microbubble warning  is visible on the display.
- Plan a day without diving once a week.
- If you have to change computers, wait at least 48 hours before carrying out your next dive.

**Altitude and diving**

- Do not dive at altitudes higher than 4000m (13000 feet).
- After a dive do not rise to altitudes that the computer prohibits via the flashing altitude segments (see page 25).



**Flying after diving**

- After diving, wait at least 24 hours prior to flying.



Smart Z dive instrument is a personal protective equipment in compliance with the essential safety requirements of the European Union directive 89/686/EEC. RINA SpA, Via Corsica 12, I-16128 Genoa, notified body no. 0474, have certified the conformity with the European Standard EN 250:2000 and EN 13319:2000.

EN250:2000 Respiratory equipment - Open circuit self contained compressed air diving apparatus - Requirements, testing, marking (pressure gauge test).

EN13319:2000 Diving accessories - Depth gauges and combined depth and time measuring devices - Functional and safety requirements, test methods. Any information on decompression obligation displayed by equipment covered by this standard is explicitly excluded from its scope.

## Introduction

Congratulations on purchasing a Smart Z dive computer and welcome to UWATEC. From now on you will enjoy the assistance of the most extraordinary dive computer - equipped with UWATEC's most innovative technology - while diving.

We thank you for choosing this computer and we hope you will enjoy safe dives in the future! Further information on UWATEC Smart dive computers and other products by UWATEC can be found on our web page at [www.uwatec.com](http://www.uwatec.com). To make this manual easier to read we will use the term 'Smart Z' as an abbreviation for 'UWATEC Smart Z diving computer' throughout this booklet.

### Safety considerations

*Dive computers provide divers with data; they, however, do not provide the knowledge how this data should be understood and applied. Dive computers cannot replace common sense! You must therefore carefully read and understand this entire manual before using your Smart Z.*

## Important remarks concerning signal words and symbols

This operating manual makes use of the following icons to indicate especially important comments:

### Remarks



Information and tips which are important for optimal use of the functions of Smart Z.

### Danger!



Indicates a potentially hazardous situation which, if not avoided, could result in death or serious injury.

## The following symbols are used in the operating manual:



Flashing display

-> Page reference  
e.g. ->10

### Audible signals

») 4 sec. ») Audible attention signal

»)»)»)») Audible alarm signal

### Instructions for manual input



#### Bridge contacts

Example: bridging contacts B and E

# Quick reference

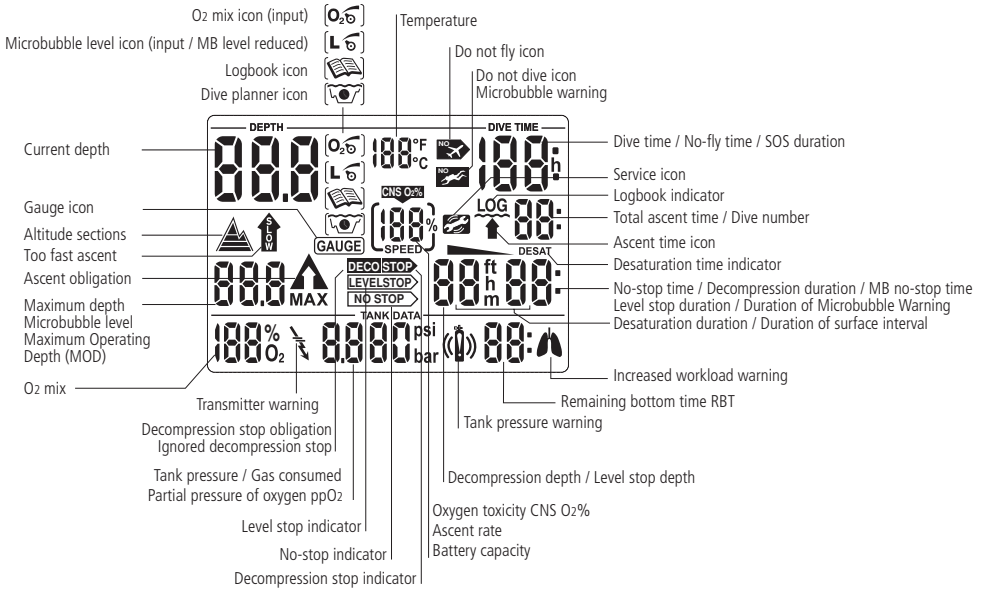

## Operating scheme

- Start / Confirmation / Enter
- + / Navigate
- / Navigate

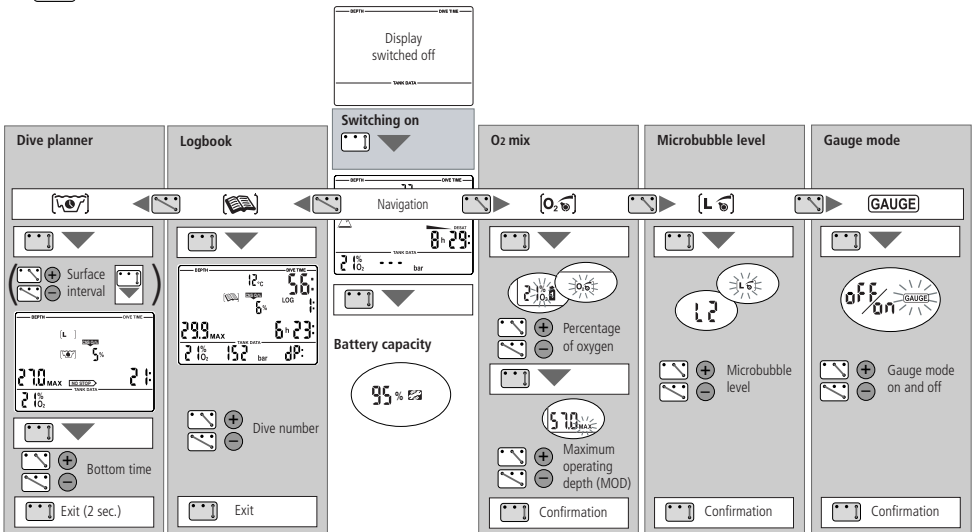

Display switches off automatically after 3 minutes without operation.

## List of chapters

<b>I</b>	<b>Safety considerations</b>	<b>2</b>
	<b>Introduction</b>	<b>4</b>
	<b>Important remarks concerning signal words and symbols</b>	<b>4</b>
	<b>Quick reference / Operating scheme</b>	<b>5</b>
	<b>List of chapters</b>	<b>6</b>
<b>II</b>	<b>System and operation</b>	<b>8</b>
1	System description	8
2	Operation	8
2.1	Operating elements	8
2.2	SmartTRAK	9
2.3	Switching on the display	10
2.4	Checking the battery capacity	10
2.5	Selection and activation of user functions	10
2.6	Active backlight	11
2.7	Switching off the display	11
3	SOS mode	11
4	Setting up Smart Z	12
4.1	Mounting of transmitter	12
4.2	Pairing of transmitter and dive computer	13
<b>III</b>	<b>Diving with Smart Z</b>	<b>15</b>
1	Terminology / Symbols	15
1.1	General terminology / Display during no-stop phase	15
1.2	Display during decompression phase / Remaining Bottom Time	15
1.3	Nitrox information (O <sub>2</sub> information)	16
2	Attention messages and alarms	17
2.1	Attention messages	17
2.2	Alarms	17
3	Preparation for the dive	18
3.1	Setting the gas mixture and MOD	18
3.2	Setting the MB level	18
3.3	Preparation for the dive and function check	18
4	Functions during the dive	19
4.1	Immersion	19
4.2	Dive time	19
4.3	Current depth	19
4.4	Maximum depth	19
4.5	Temperature	19
4.6	Ascent rate	19
4.7	Partial pressure of oxygen (ppO <sub>2</sub> ) / Maximum Operating Depth (MOD)	20
4.8	Oxygen toxicity (CNS O <sub>2</sub> %)	21
4.9	Tank pressure	21
4.10	Remaining Bottom Time (RBT)	22
4.11	Decompression information	22
5	Functions at the surface	24
5.1	End of a dive	24
5.2	Desaturation time	24
5.3	No-fly time	24
5.4	Microbubble warning	24

6	Diving in mountain lakes	25
6.1	Altitude ranges	25
6.2	Prohibited altitude	25
6.3	Decompression dives in mountain lakes	25
<b>IV</b>	<b>Gauge mode</b>	<b>26</b>
<b>V</b>	<b>Diving with microbubble levels (MB)</b>	<b>28</b>
1	Comparison of dives with MB level L0 and MB level L5	28
2	Terminology	29
2.1	Display during microbubble (MB) no-stop phase	29
2.2	Display during level stop phase	29
3	Preparation for a dive with microbubble levels (MB levels)	30
3.1	Setting the MB level	30
4	Functions during the dive with microbubble levels	30
4.1	Level stop information	30
4.2	Total time of ascent	31
4.3	Decompression obligation	31
4.4	Level stop and deco stop	32
5	Complete a dive with MB levels	32
<b>VI</b>	<b>Dive planner</b>	<b>33</b>
1	Planning a no-stop dive	33
2	Planning a decompression dive	34
3	Leaving the dive planner	34
<b>VII</b>	<b>Logbook</b>	<b>35</b>
1	Survey	35
2	Operation	35
<b>VIII</b>	<b>Appendix</b>	<b>36</b>
1	Technical information	36
2	Maintenance	36
2.1	Replacing the battery of the transmitter	36
3	Conversion of tank pressure	38
4	Warranty	38
5	FCC	39
6	Index	39

## II System and operation

### 1 System description

Smart Z displays all important dive and decompression data and comes with a unique receiver which can receive tank pressure data from a transmitter. Mounted at the high pressure (HP) outlet of the regulator, the transmitter measures the tank pressure and radio transmits the information to Smart Z. UWATEC's specially patented transmission process prevents interference and ensures continuous and reliable reception. Smart Z has a data memory which stores the dive data. The data can be transmitted with an infrared interface (IrDA) and the SmartTRAK software to a Windows® personal computer. The SmartTRAK CD software is included with the Smart Z Package. Infrared interfaces are available in PC stores. A list of recommended interfaces is available on the UWATEC homepage ([www.uwatec.com](http://www.uwatec.com)).

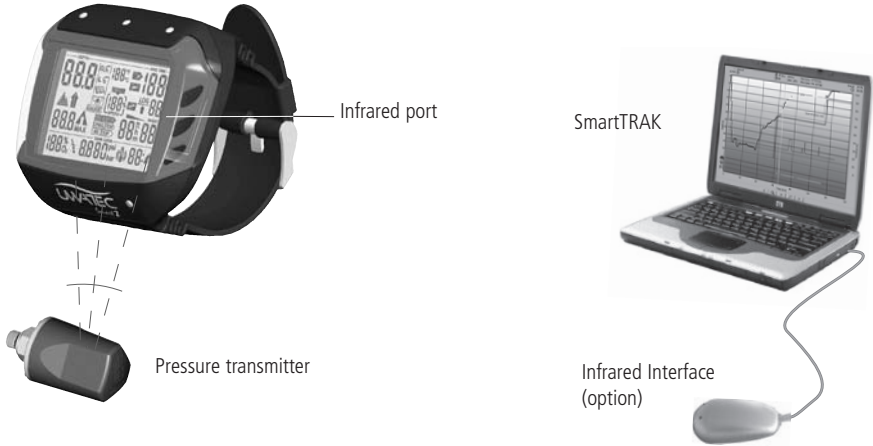

## 2 Operation



On page 5 you will find an operating schematic.

### 2.1 Operating elements Contacts



Smart Z has 4 operating contacts B, E, +, - on the outside of the housing. For manual operation, touch base contact B and any one of the other three contacts above the display with moistened fingers («bridging» contacts).

**Contact B:** Base contact, which has to be touched for all operations.

**Contact E:** Enter contact. It serves to switch on Smart Z and to confirm or enter the displayed value. It is therefore comparable to the ENTER or RETURN key of a keyboard.

**+ / - Contacts:** These allow to navigate between menus and, once inside a menu, to increase or decrease the indicated value.



**2.2 SmartTRAK**

With SmartTRAK you can transfer dive data to a personal computer and graphically display the data.

The following settings may be changed with SmartTRAK:

- |   |                               |
|---|-------------------------------|
| • Unit system   | metric/imperial               |
| • Audible attention signal suppression  | selective                     |
| • Gauge mode  | on / off                      |
| • Depth alarm   | 5 - 100 m (20 - 330 feet)     |
| • Backlight illumination duration   | 2-12 sec.                     |
| • Maximum partial pressure of oxygen (ppO <sub>2 max</sub> )                  | 1-1.95 bar                    |
| • Time limit to reset the O <sub>2</sub> % mix to air                         | no reset / 1 - 48 hrs.        |
| • Minimum reserve pressure at the end of the dive (basis for RBT calculation) | 20 – 120 bar (300 - 1750 psi) |
| • Tank pressure alarm   | 50 - 200 bar (750 - 2900 psi) |
| • Workload sensitivity  | 25 steps                      |

The following data may be recalled with SmartTRAK:

- |                                 |   |
|---------------------------------|---|
| • Number of past dives          | ✓ |
| • Total duration of past dives  | ✓ |
| • Atmospheric pressure          | ✓ |
| • Pairing information           | ✓ |
| • Dive profile                  | ✓ |
| • Logbook                       | ✓ |
| • Temperature curve             | ✓ |
| • Workload curve                | ✓ |
| • Alarms and attention messages | ✓ |

### 2.3 Switching on the display

- automatically, on submerging in water or when adaptation to atmospheric pressure is necessary;
- manually, by bridging contacts on housing (B-E).

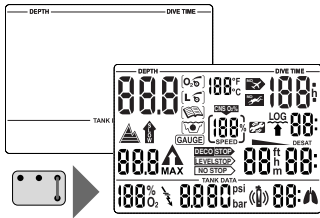

- When Smart Z is in state of rest no information is displayed but the atmospheric pressure is continuously monitored. If a higher altitude range is detected, Smart Z switches on for 3 minutes automatically -> 25.
- Smart Z switches on by bridging the contacts B and E. All segments light up for 5 seconds.

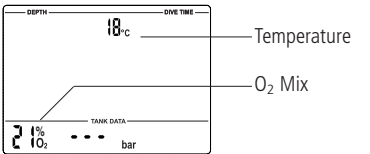

Temperature  
O<sub>2</sub> Mix

Afterwards the display shows the selected O<sub>2</sub> mix, the temperature and in certain circumstances an altitude range ->25.

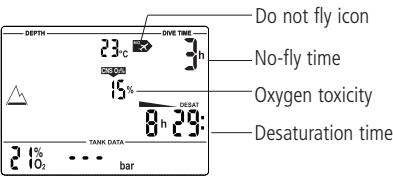

Do not fly icon  
No-fly time  
Oxygen toxicity  
Desaturation time

If the transmitter is switched on and located within transmitting distance, the tank pressure is displayed, otherwise "---" will be displayed. If no transmitter has been paired yet, the display will be blank.

If there is a remaining saturation due to the last dive or change of altitude, Smart Z also displays the remaining desaturation time, the oxygen toxicity and the "no-fly time" ->24.

### 2.4 Checking the battery capacity



95%

Battery capacity

After switching on Smart Z you can check the battery capacity by bridging the contacts B and E. The remaining capacity is displayed for 3 seconds as a percentage. If the value reaches 0%, the battery warning gets activated (>17) and the battery has to be replaced by an authorised SCUBAPRO UWATEC dealer.

For a 7-day diving vacation Smart Z uses between 2 – 5 % of its battery capacity.

### 2.5 Selection and activation of user functions

- Gauge mode ->26
- Input microbubble level ->30
- Input O<sub>2</sub> mix ->18
- Logbook ->35
- Dive planner ->33

At the surface you can select the dive planner, the logbook and gauge mode as well as the functions to enter the O<sub>2</sub>% mix and the microbubble levels by bridging the contacts + and B or – and B.



After the selection of the desired function you can activate and deactivate it by bridging the contacts B and E.



Details to the user functions are to be found on the pages mentioned above.

## 2.6 Active backlight



The display of Smart Z can be illuminated both on the surface and underwater.

The backlight can be activated by pressing on top of the case. The light will turn off automatically after 8 seconds or after the time selected via SmartTRAK.

The backlight can only be activated if the computer display is on.

## 2.7 Switching off the display

On the surface Smart Z switches off automatically after 3 minutes without operation.

## 3 SOS mode

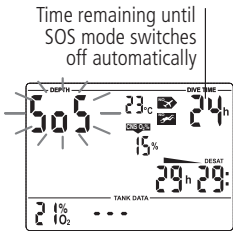

Activation: automatic

If the diver remains above a depth of 0.8m (3 feet) for more than three minutes without observing a prescribed decompression, the computer will automatically switch into SOS mode after the dive.

The display shows the "SOS" sign and the remaining length of the SOS mode. The dive will be entered in the logbook with "SOS". Other than that the SOS mode has no further impact on the displays and functions on the surface.



- Serious injury or death may result if a diver does not seek immediate treatment should any signs or symptoms of decompression sickness occur after a dive.

- Do not dive to treat symptoms of decompression sickness!
- Diving in SOS mode is extremely dangerous and you must assume full responsibility for such behaviour. UWATEC will assume no liability.

Once in the SOS mode, the computer will lock up and will be inoperable as a diving instrument for 24 hours.



A diving accident can be analyzed at any time in the logbook and downloaded to a PC by means of the infrared interface (IrDA) and the SmartTRAK software.

## 4 Setting up Smart Z (transmitter and dive computer)

### 4.1 Mounting of transmitter

The transmitter is mounted at the high pressure (HP) outlet of the regulator's first stage before the first dive.



Use air and Nitrox components in accordance with the law of the country.

Procedure:

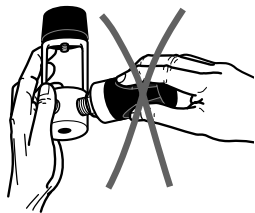

Do not hold the transmitter by its plastic part.

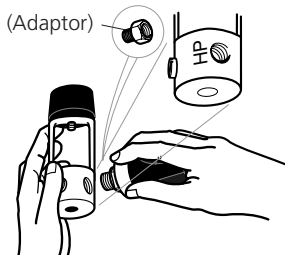

Mount the transmitter at the HP outlet. If the threads do not match, you can get a fitting adaptor at your diving equipment retailer.

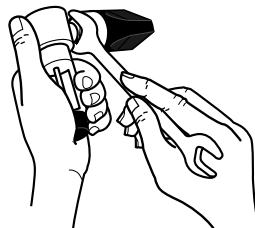

Tighten the transmitter by means of a size 3/4" wrench.

The transmitter is best mounted laterally on the regulator.

It is advisable to mount the transmitter on the same side that the computer is located. This is the optimal position for transmission.

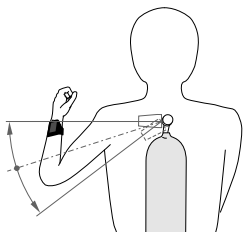

Position of the transmitter for left handers.

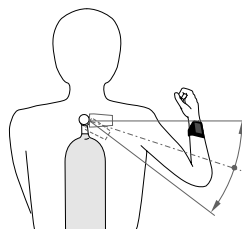

Position of the transmitter for right handers.

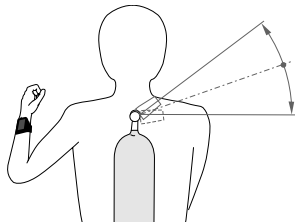

Position of the transmitter for left handers, if there is no connection possible on the left hand side.

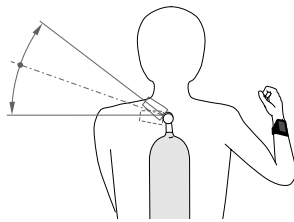

Position of the transmitter for right handers, if there is no connection possible on the right hand side.

### 4.2 Pairing of transmitter and dive computer

To receive the data of the transmitter, the transmitter itself must be paired with Smart Z.

Pairing is necessary:

- before the first use of Smart Z with the transmitter;
- if you use a new transmitter or a new computer;
- after changing the battery.

#### Pairing procedure:

1. Shut the valve, depressurise the regulator and wait for 15 seconds.
2. Switch on Smart Z (bridge contacts B and E).



3. Move the dive computer and transmitter into the shown position.



Transmitter and dive computer must be in physical contact during the entire pairing procedure.

4. Open the tank valve. The transmitter briefly sends a pairing sequence to the computer.
5. The dive computer shows a flashing "PAIr" shortly after the valve has been opened.
6. In order to confirm the pairing, the B and E contacts have to be bridged within 5 sec. A beep confirms the input and the "PAIr" display remains still.
7. "PAIr" disappears after approx. 10 sec.

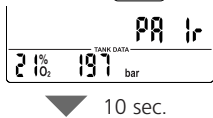
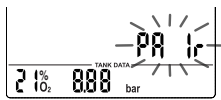

10 sec.



In case of faulty pairing, the display "FAIL" appears instead of "PAIr". In that case, completely purge the regulator and repeat the pairing procedure. This is only possible after at least 15 seconds.



- Pairing of transmitter and dive computer may already be carried out at home and need only be executed once, before the first use.
- You may delete the pairing of transmitter and dive computer by means of the SmartTRAK software.

### How to check if transmitter and computer are paired correctly:



Pairing ok

1. Switch on the computer manually (B and E)
2. Move the computer into transmitting range of the transmitter.
3. Open the tank valve. The transmitter switches on automatically.
4. Check the display: Pairing has been carried out correctly if the pressure is displayed within 5-10 seconds.

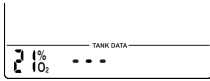

Pairing present, no pressure data available

If the transmitter has been correctly paired, but Smart Z cannot receive the tank pressure, " - - - " will appear on the display. In that case, check the position of transmitter and dive computer.



Pairing not present

If the transmitter has not been paired, or if an existing pairing has been deleted via SmartTRAK, the display will remain empty. In that case, transmitter and computer must be paired again.

1 Terminology / Symbols

The information on the display of Smart Z varies depending on the kind of dive and the dive phase.



For information about diving with microbubble levels (MB levels) see chapter V ->28.

1.1 General terminology / Display during no-stop phase

Oxygen toxicity

CNS O<sub>2</sub>%

Ascent rate

(Only while ascending)



Current depth

In metres (feet)

Temperature

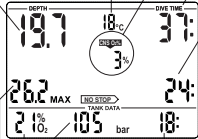

Dive time

Duration of the dive (min)

No-stop time

Remaining time at a given depth during which ascent is allowed without decompression stop (min).

RBT, Remaining bottom time

Tank pressure

O<sub>2</sub>% Mix

Selected oxygen fraction

Maximum depth

reached during the dive

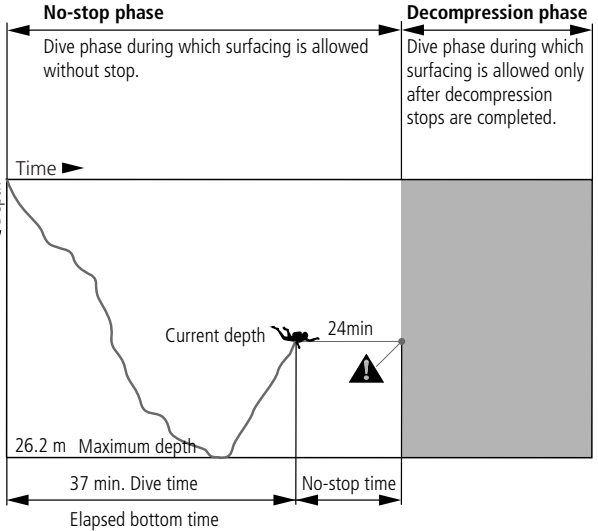

1.2 Display during decompression phase / Remaining Bottom Time (RBT)

Decompression stop

All required decompression stops must be observed.

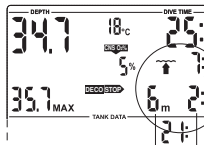

Decompression stop depth

Deepest stage is displayed.

Decompression stop duration

Prescribed duration of the decompression stop at the displayed decompression stage (minutes).

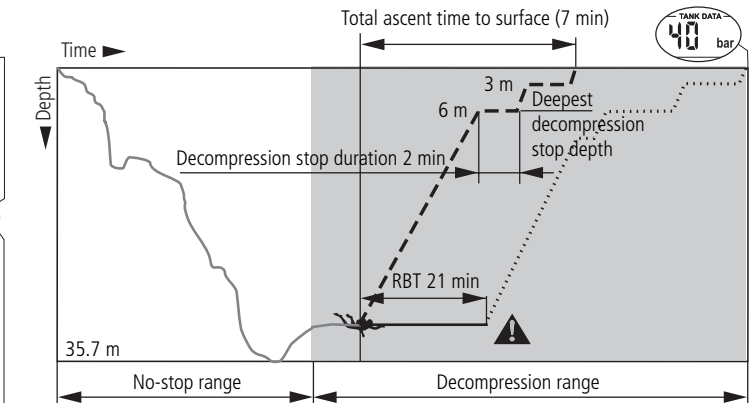

Total ascent time

Including decompression stops in minutes.

Remaining Bottom Time, RBT

Maximum remaining time at current depth including all decompression obligations (minutes).



### 1.3 Nitrox information (O<sub>2</sub> information)

For dives with compressed air in normal recreational diving, nitrogen is the decisive gas for the decompression calculations. When diving with Nitrox, the risk of oxygen toxicity rises with the increase of the fraction of oxygen and the increase of depth and can limit dive time and the maximum depth. Smart Z includes this in the calculations and displays the necessary information:

"O<sub>2</sub>% MIX"

Fraction of oxygen: The fraction of oxygen in the Nitrox mixture can be set between 21% (normal compressed air) and 100% in 1% increments. Your selected mix will be the basis for all calculations.

ppO<sub>2</sub> max.

Maximum allowed partial pressure of oxygen: the higher the fraction of oxygen in the mixture, the shallower the dive depth at which this value of the partial pressure of oxygen is reached. The depth at which ppO<sub>2</sub> max. is reached is called Maximum Operating Depth (MOD). Default setting is 1.4 bar, but it can be set by means of SmartTRAK between 1.0 and 1.95 bar. When you enter the settings for the gas mixture, Smart Z will display the ppO<sub>2</sub> max. limit setting and the corresponding MOD. Smart Z warns the diver audibly and visually once the depth is reached at which the ppO<sub>2</sub> reaches the maximum allowed value.



- The partial pressure limit set by means of SmartTRAK can be reduced manually at Smart Z (->18, setting the gas mixture).
- The CNS O<sub>2</sub>% value/alarm is not influenced by the selected ppO<sub>2</sub>max. setting.

"CNS O<sub>2</sub>"

Oxygen toxicity: With the increased percentage of oxygen, the oxygen in the tissues (especially in the central nervous system (CNS)) becomes important. If the partial pressure of oxygen rises above 0.5 bar, the CNS O<sub>2</sub> value increases, if the partial pressure of oxygen is below 0.5 bar, the CNS O<sub>2</sub> value decreases. The closer the CNS O<sub>2</sub> value is to 100%, the closer the limit where symptoms can occur. See page 21.

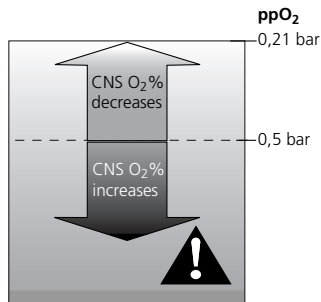

Nitrox diving may only be attempted by experienced divers after proper training from an internationally recognized agency.



## 2 Attention messages and alarms



Smart Z draws the diver's attention to certain situations and warns the diver of unsafe diving practices. Attention messages and alarms are always visual and audible under water, only visual at the surface except the decompression alarm.



The audible attention messages (but not the alarms) can be selectively switched off with SmartTRAK.



### 2.1 Attention messages

Attention messages are communicated to the diver visually by symbols, letters or flashing figures. In addition, two short audible sequences can be heard (in an interval of 4 seconds) in two different frequencies under water.

••) 4 sec ••) (can be switched off)

### 2.2 Alarms

Serious injury or death may result from failing to immediately respond to alarms given by Smart Z.

Alarms are given to the diver visually by flashing symbols, letters or figures. In addition, an audible sequence in one frequency can be heard during the whole duration of the alarm.

••)••)••)••)••) ••)••)••)••)••) (can not be switched off)

Attention messages come up in the following situations (more information can be found on the listed pages):

	Page
• Maximum Operating Depth / max ppO <sub>2</sub> is reached	20
• Set maximum depth is reached	19
• Oxygen toxicity reaches 75%	21
• No-stop time = 2 minutes	22
• Prohibited altitude* (surface mode)	25
• Entering decompression when diving with L0	23
• Remaining Bottom Time < 3 minutes	22
• Tank pressure has reached set warning level	21
• Increased workload	21

An alarm occurs in the following situations (more information can be found on the listed pages):

	Page
• Oxygen toxicity reaches 100%	21
• Ignored decompression	23
• Remaining Bottom Time = 0	22
• Exceeding the prescribed ascent rate (Particular scale of beeps, ->20)	20
• Low battery alarm**	see below

#### Low battery alarm Smart Z\*\*

The service symbol appears if the battery capacity reaches 0%.



Take the unit to your authorised SCUBAPRO UWATEC retailer.

Diving with microbubble levels (L1-L5):

• MB no-stop time = 0	30
• MB level stop ignored	31
• MB level reduced	31
• Entering decompression when diving with MB level L1-L5	31

#### Transmitter battery low: \*\*

"bAt" flashing and alternating with the display of the tank pressure.



Replace the battery in the transmitter ->36.

\*without audible attention beep

\*\*without audible alarm

### 3 Preparation for the dive

#### 3.1 Setting the gas mixture and MOD



Before every dive and after changing the tank, make sure that the settings for the gas mixture correspond with the current mixture used. An incorrect setting causes Smart Z to miscalculate this particular dive. If the fraction of oxygen is set too low this can lead to oxygen poisoning without warning. If the value is set too high decompression sickness may occur. Inaccuracies in the calculations are carried over to repetitive dives.

To set the gas mixture, Smart Z must be in user mode.

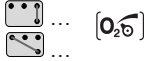

1. Bridge contacts B and + or B and – until the symbol for the setting of the O<sub>2</sub> mixture appears.



2. Confirm that you wish to change the displayed oxygen fraction by bridging B and E.



3. Change the oxygen fraction in increments of 1% by bridging B and + or B and –. Smart Z will display the current fraction of oxygen, the maximum partial pressure limit, ppO<sub>2</sub> max (as pre-set by means of SmartTRAK) and the MOD.

4. Confirm the selected percentage with B and E.

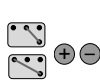

5. By bridging B and + or B and – you can change the MOD for the chosen fraction of oxygen. Smart Z will now display the corresponding partial pressure limit (ppO<sub>2</sub> max) for the new MOD.

6. Confirm your MOD settings with B and E.

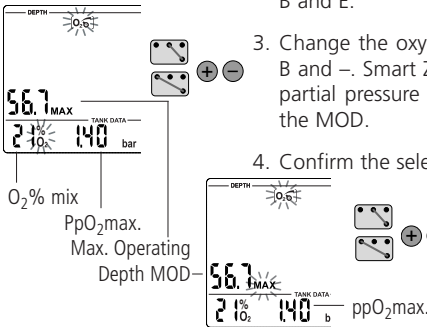

- Without confirmation the display will disappear after 3 minutes and your entries will not be accepted.
- The time to reset the O<sub>2</sub> % mix to air can be set with SmartTRAK between 1 and 48 hours or to "no reset" (default).

#### 3.2 Setting the MB level See chapter V, ->28

#### 3.3 Preparation for the dive and function check

The following descriptions of the preparation are based on the assumption that the transmitter has been correctly mounted at the HP outlet of the regulators (->12) and successfully paired with Smart Z (->13).

1. Mount the regulator together with the transmitter on the tank



2. If present, check the reserve valve of your tank, the reserve valve must be open.

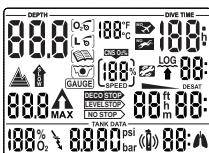

3. Switch on Smart Z (B-E) and check the test display: Are all elements of the display activated? Do not use Smart Z if the display does not show all elements.

4. Open the valve (transmitter will switch on automatically) and check the tank pressure (after approx. 10 seconds). If the pressure is insufficient, change the tank.

5. Check the connections and instruments for leaks. Never dive with leaky equipment!

## 4 Functions during the dive

### 4.1 Immersion

After immersion, starting at a depth of about 0.8 m (3 ft), all diving functions are monitored, i.e. depth and dive time displayed, maximum depth stored, saturation of tissues calculated, no-stop time or decompression prognosis determined, ascent rate controlled and displayed and the correctness of the decompression procedure supervised. In addition, Smart Z also shows the tank pressure and about 2 minutes into the dive the Remaining Bottom Time (RBT) is displayed.

### 4.2 Dive time

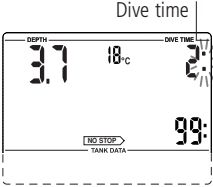

The whole time spent below a depth of 0.8m (3 feet) is displayed as dive time in minutes. The time above 0.8m (3 feet) is counted as dive time only if the diver descends again below 0.8m (3 feet) within 5 minutes.

While the dive time is running, the colons on the right of the figures are flashing in one second intervals. Maximum dive time displayed is 199 minutes.



If a dive lasts longer than 199 minutes the dive time display starts again at 0 minutes.

### 4.3 Current depth

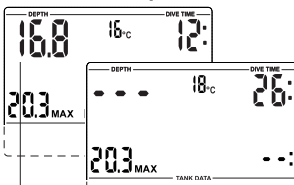

Current depth

Current depth is given in 10 cm increments (1 foot). At a diving depth of less than 0.8 m (3 ft) the display shows " ---".



Depth measurement is based on freshwater. Therefore, Smart Z shows a slightly greater depth when diving in salt water, depending on the salinity of the water. No calculation however is affected.

### 4.4 Maximum depth

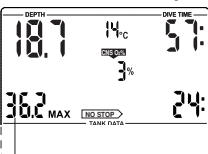

Maximum depth

Maximum depth is only displayed if it exceeds the current depth by more than 1 m (3 feet) (maximum indicator function).

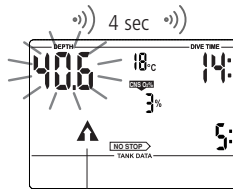

Ascent arrow



#### WARNING

#### Set maximum depth reached

If the maximum depth set with SmartTRAK has been reached (default 40m/130 feet), the current depth will flash and the ascent arrow will be displayed.

Ascend until the ascent arrow disappears.

### 4.5 Temperature

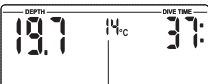

Temperature

Smart Z permanently displays the temperature, under water and on the surface as long as the computer is turned on.

### 4.6 Ascent rate

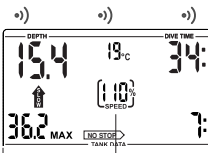

Ascent rate

Optimal ascent rate varies depending on depth between 7 and 20 m/min (23 and 67 ft/min). It is displayed as a percent of the reference variable ascent rate. If the ascent rate is greater than 100% of the set value, the black arrow "SLOW" appears. If the ascent rate exceeds 140%, the arrow starts flashing. Smart Z provides an audible alarm if the ascent rate is 110% or greater. The intensity of the alarm increases in direct proportion to the degree that the prescribed ascent rate is exceeded.



The prescribed ascent rate must be observed at all times! Exceeding the prescribed ascent rate can lead to microbubbles in the arterial circulation which can lead to serious injury or death due to decompression sickness.

- In case of an improper ascent Smart Z may require a decompression stop even within the no-stop phase because of the danger of microbubble formation.
- The decompression duration necessary for the prevention of microbubbles can increase massively if the ascent rate is exceeded.
- From great depth a slow ascent may cause heightened saturation of tissues and an extension of both decompression duration and total ascent time. At shallow depth, a slow ascent may shorten the decompression duration.
- Display of the ascent rate has the priority over "CNS O<sub>2</sub>".



Ascent rate	Visual alarm	Audible alarm			
(10% SPEED)		)	)	)	)
(40% SPEED)		)	)	)	)
(60% SPEED)		)	)	)	)
(80% SPEED)		)	)	)	)

Reduce ascent rate

Excessive ascent rates for longer periods are entered in the logbook.

The following ascent rates correspond to the 100% value in Smart Z.

depth (m)	<6	<12	<18	<23	<27	<31	<35	<39	<44	<50	>50
speed (m/min)	7	8	9	10	11	13	15	17	18	19	20
depth (ft)	<20	<40	<60	<75	<88	<101	<115	<128	<144	<164	>164
speed (ft/min)	23	26	29	33	36	43	49	56	59	62	66

#### 4.7 Partial pressure of oxygen (ppO<sub>2 max</sub>) / Maximum Operating Depth (MOD)

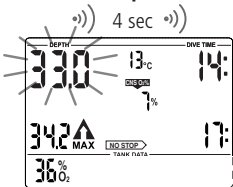

The maximum partial pressure of oxygen ppO<sub>2 max</sub> (default 1.4 bar) determines the Maximum Operating Depth (MOD). Diving deeper than the MOD will expose the diver to oxygen partial pressures higher than the set maximum level.

The MOD and consequently the ppO<sub>2 max</sub> can be reduced manually at Smart Z (>18, setting the gas mixture, point 5).

In addition the maximum allowed ppO<sub>2</sub> can be set by means of SmartTRAK between 1.0 to 1.95 bar.



The MOD is a function of ppO<sub>2 max</sub> and the mixture used. If during the dive the MOD is reached or exceeded Smart Z sends an audible attention message, the ascent arrow appears and the current depth display starts flashing.

Ascend to a shallower depth in order to diminish the danger of oxygen poisoning.



- The MOD should not be exceeded. Disregarding the warning can lead to oxygen poisoning.
- ppO<sub>2 max</sub> should not be set higher than 1.6 bar.

### 4.8 Oxygen toxicity (CNS O<sub>2</sub>%)

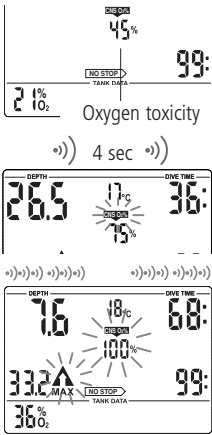

Oxygen toxicity

4 sec

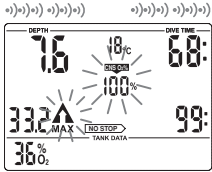
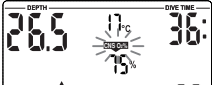

Smart Z calculates oxygen toxicity from depth values, time and the gas mixture and displays it in the location of the ascent rate. The toxicity is expressed in 1% increments of a maximum tolerated value (O<sub>2</sub> clock). The symbol "CNS O<sub>2</sub>" is displayed together with the percentage.



**WARNING**  
An audible attention signal goes off if oxygen toxicity reaches 75%. The symbol "CNS O<sub>2</sub>" flashes and the ascent arrow appears. Ascend to shallower depth to decrease oxygen loading.



**WARNING**  
When oxygen toxicity reaches 100%, an audible alarm goes off every 4 seconds. "CNS O<sub>2</sub>", the percentage value and the ascent arrow flash. Danger of oxygen toxicity!  
Start ascent at once.

- During an ascent and if the CNS O<sub>2</sub> % value does not increase anymore (due to a lower partial pressure of oxygen), the audible warning is suppressed.
- During the ascent, the display of the oxygen toxicity is replaced by the ascent rate. If the ascent is stopped, the display changes back to the indication of the CNS O<sub>2</sub> % value.
- Smart Z will display CNS O<sub>2</sub> % values exceeding 199 % with 199 %.

### 4.9 Tank pressure



The tank pressure is also used for the calculation of the remaining bottom time (RBT) and the workload.

4 sec



**WARNING**  
When the tank pressure reaches the set warning pressure (SmartTRAK) an audible alarm goes off and the tank symbol is shown. Default value of warning pressure: 100 bar (1450 psi)  
Do not dive any deeper. Start to ascend soon.

4 sec



**WARNING**  
In case of increased workload, Smart Z displays a lung symbol and an audible alarm goes off. (The sensitivity of workload can be changed with SmartTRAK).  
In order to prevent additional saturation, reduce exertion, relax and breathe more slowly.

4 sec

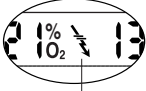

**WARNING**  
If Smart Z receives no data for 30 seconds, an audible alarm goes off and the transmitter warning appears.

If Smart Z does not receive pressure data for another 40 seconds, it will activate another audible alarm. RBT and transmitter warning will no longer be displayed. Instead of the tank pressure value Smart Z will display " - - - ". Check the position of transmitter and Smart Z. Start ascending at once. Smart Z will switch back to its normal display as soon as new data is received.

Transmitter warning



If tank pressure < 14 bar/200psi



**WARNING**  
If the tank pressure is lower than 14bar/200psi the transmitter switches off and Smart Z will display " - - - ".  
Do not let the tank pressure drop below 14bar / 200psi.

## 4 Functions during the dive

### 4.10 Remaining Bottom Time (RBT)



RBT is the time left at the current depth until the point of time when the ascent must be started. The RBT is calculated on the basis of the current tank pressure, breathing rate, the temperature, and the dive data so far recorded. The RBT is based on the assumption that the tank pressure should amount to the set pressure (default 40 bar/600 psi) at the end of the dive. Alterations can be made with SmartTRAK. A graphic representation of RBT is on page 15.



Never allow the RBT to go below three minutes. If the RBT goes below three minutes there is a danger of insufficient supply of gas mixture for the ascent as well as an increased risk of decompression sickness, and serious injury or death may result!

Correct calculation of RBT when using a reserve or "J" type valve is possible only if the reserve function of the valve is in the open (down) position during the dive.

))) 4 sec )))

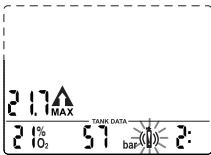

RBT < 3 minutes

)))))) )))))) )))))) ))))))

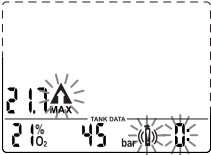

RBT = 0 minutes



If the RBT drops below three minutes, an audible attention signal is activated, the ascent arrow is displayed and the tank icon start flashing. Start ascent immediately.



The RBT value should never reach "0:". With RBT=0 the remaining tank reserve may not be sufficient for the ascent.

When the last minute has passed (RBT=0) an audible alarm is activated every 4 seconds. The RBT, the ascent arrow and the tank icon start flashing. The audible alarm on exceeding the RBT is suppressed at depths less than 6.5 m (21 ft) if Smart Z is in the no-stop phase. Start ascent at once.

### 4.11 Decompression information

No-stop time is displayed if no decompression stops are necessary. The arrow  is visible if no decompression stops are necessary. The figures indicate no-stop time in minutes.

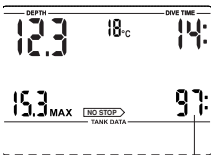

No-stop time

))) 4 sec )))

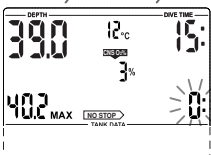

- No-stop display "99:" means remaining time of 99 minutes or more.
- No-stop time is calculated on line and influenced by the current workload and current water temperature



If no-stop time drops below 3 minutes, an audible attention signal is activated and the no-stop value begins to flash.

If no-stop time is less than 1 minute, the no-stop display shows the flashing value "0". In order to prevent a decompression dive, ascend slowly until the no-stop time is 5 minutes or more.



Dives that require decompression stops are not recommended.

**Decompression values**

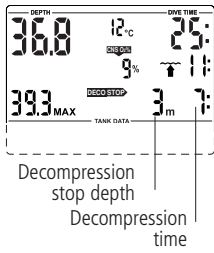

On entering the decompression phase, the arrow **NO STOP** disappears, the arrow **DECOSTOP** appears and an attention beep goes off. Right beside the arrow, the deepest decompression stage in metres (feet) is displayed. Next to the decompression stop depth, the decompression stop duration of the displayed stage appears in minutes. The display "3m 7:" means that a decompression stop of 7 minutes at a depth of 3m has to be made. When a decompression stop has been finished, the next higher decompression stop is displayed. When all decompression stops have been made, the arrow **DECOSTOP** extinguishes and the arrow **NO STOP** reappears. The indication of time on the lower right shows the no-stop time again.

Deco stop depths deeper than 27m (90 ft) are displayed as "-- : --".

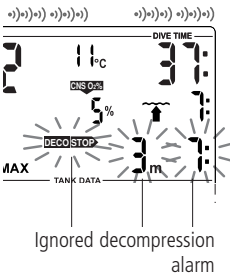

**WARNING**

The decompression alarm is activated if the decompression stop is ignored. The arrow **DECOSTOP**, the decompression stop duration and decompression stop depth begin to flash and an audible alarm goes off.

Due to the formation of microbubbles, decompression can increase massively if a decompression stop is ignored. When the surface is reached during the decompression alarm, the arrow **DECOSTOP**, the decompression stop duration and decompression stop depth continue flashing, in order to point to the risk of a decompression accident. The SOS mode is activated 3 minutes after the dive if corrective action is not taken (->11). If the total (cumulative) duration of the decompression alarm is longer than one minute, it is entered in the logbook.

Descend to the prescribed decompression stop depth immediately!

**Total time of ascent**

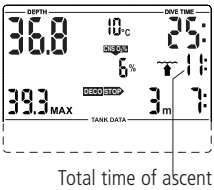

As soon as decompression stops are necessary Smart Z shows the total time of ascent. This includes the ascent time from the current depth to the surface and all decompression stop obligations.

The total time of ascent is calculated on the basis of the prescribed ascent rate and a normal workload. Total time of ascent can be subject to change if the ascent rate is not ideal (100%) or if Smart Z detects a higher workload. Ascent time greater than 99 minutes is displayed as "--".

**WARNING**

On all dives with Smart Z, make a safety stop for at least three minutes at a depth of 5 m (15 feet).

## 5 Functions at the surface

### 5.1 End of a dive

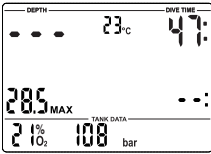

After reaching the surface (<0.8 m/3 ft) Smart Z remains in dive mode for 5 minutes. The delay allows for surfacing for a short period for orientation.

After 5 minutes the dive is closed and it is entered into the logbook.



For the calculations of the desaturation and no-fly time it is assumed that the diver breathes air while on the surface.

### 5.2 Desaturation time

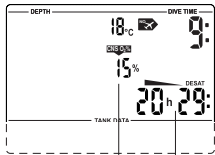

Oxygen toxicity

Desaturation time

After the dive has been closed  **DESAT**, desaturation time in hours and minutes and, if available, oxygen toxicity is displayed. Desaturation time is determined either by oxygen toxicity, nitrogen saturation or the regression of microbubbles, depending on which requires the longer time. Oxygen toxicity ("CNS O<sub>2</sub>") is displayed and adjusted until the value becomes 0%.

Desaturation time is indicated until the next dive or until it reaches zero.

The display is switched off to save energy three minutes after the last manipulation is made. The calculations are nevertheless continued in the background.

### 5.3 No-fly time

No-fly time

Do not fly icon

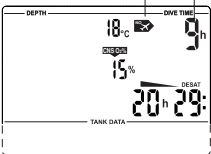

The "no-fly time" is indicated beside the icon "do not fly". "No-fly time" is the time in hours that should pass before a flight and is displayed and adjusted until the value becomes 0 hours.



Flying while Smart Z displays "do not fly" may lead to serious injury or death from decompression sickness.

### 5.4 Microbubble warning

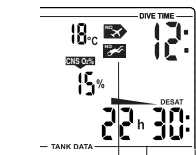

Microbubble warning

Desaturation time

Through repetitive dives microbubbles accumulate in the lungs if the surface interval is not long enough. Ignoring decompression stops or ascending at an excessive rate can also lead to microbubbles in tissues. In order to reduce the risk of decompression sickness for repetitive dives, the surface interval should be planned long enough. If Smart Z calculates that the formation of microbubbles occurs during the surface interval, it will advise a diver to extend the surface interval via the microbubble warning. The duration of the microbubble warning is visible by entering the dive planner -> 33.



If the "microbubble warning (NO DIVE)" is visible during the surface interval, the diver should not undertake another dive.



If the dive is made in spite of the microbubble warning, the diver must cope with a clearly shorter no-stop time or an extension of decompression. Also, the duration of the microbubble warning at the end of the dive can increase considerably.



## 6 Diving in mountain lakes

### 6.1 Altitude ranges

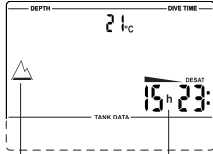

Altitude range 1

Desaturation time  
Adaptation time

Altitude ranges



Smart Z measures the atmospheric pressure every 60 seconds even while the display is switched off. If the computer detects a sufficient increase in altitude, it switches on automatically and indicates the new altitude range (1-4) and the desaturation time. Desaturation time indicated at this moment refers to adaptation time at this altitude. If the dive starts within this adaptation time, Smart Z treats it as a repetitive dive, since the body is offgassing.

Altitude is divided into five ranges, which are influenced by barometric pressure. That is why the defined altitude ranges overlap on their fringes. If a mountain lake is reached, the altitude range is indicated at the surface, in the logbook and in the dive planner by a stylised mountain filled with one or more of 4 segments representing the 4 ranges. Sea level to an altitude of approximately 1000m (3300 feet) is not indicated. In the following diagram, you can see the approximate breakdown of the altitude ranges:

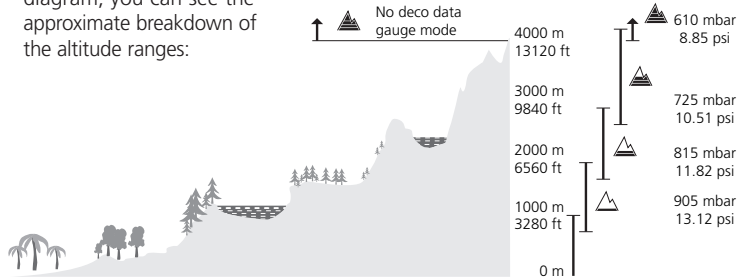

### 6.2 Prohibited altitude



Ascent to altitude range 3 and 4 prohibited.  
Max. allowed altitude:  
2650 m (8694 ft).

**WARNING** Smart Z shows via flashing altitude segments while at the surface to which altitude the diver may not rise.



Max. altitude: 850 m  
2790 ft



1650 m  
5413 ft



2650 m  
8694 ft



4000 m  
13120 ft

The ascent prohibition can also be displayed together with an altitude range:



Example: You are at 1200 m (3937 ft) (altitude range 1) and you may ascend to range 2 only (2650 m / 8694 feet). You may not rise to the altitude range 3 or 4.

### 6.3 Decompression dives in mountain lakes

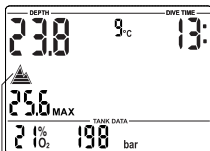

Dive at altitude range 4:

- no deco data
- no RBT

In order to assure optimal decompression even at higher altitudes, the 3m (10 ft) decompression stage is divided into a 4 m (13 ft) stage and a 2 m (7 ft) stage in altitude ranges 1, 2 and 3. The prescribed decompression stop depths are, in sequence, 2m / 4m / 6m / 9m... (7 ft / 13 ft / 20 ft / 30 ft...).

If atmospheric pressure is below 620 mbar (8.99 psi) (altitude higher than 4100 m / 13450 ft above sea level), no decompression data is calculated and displayed (automatic gauge mode). In addition RBT and the dive planner are not available anymore. The oxygen toxicity and the tank pressure are still indicated.

## IV Gauge mode



In gauge mode **ALL** audible and visual alarms and attention messages are turned off. This includes ascent speed, low tank pressure and interrupted signal from transmitter.

In gauge mode Smart Z will display depth, dive time and tank pressure, the maximum depth is stored, ascent rate and tank pressure are monitored. Gauge mode does not support the calculation of no-stop time or the supervision of decompression. Supervision of ppO<sub>2</sub> max and CNS O<sub>2</sub>% will also be switched off. Smart Z will display no information about RBT or microbubble development. The settings for gas mixtures, MOD and microbubble level cannot be set and the dive planner cannot be selected.



- Dives in gauge mode are performed at your own risk!
- After diving in gauge mode you should wait for at least 48 hours before using a decompression computer.

### Switching the gauge mode on and off

Gauge mode can be switched on and off at the surface, if no desaturation time is being prescribed.

After diving in gauge mode, Smart Z can not be used as dive computer for 48 hours.



Procedure:

1. Bridge contacts B and + or B and – until the gauge symbol and "on" or "off" are displayed.
2. Confirm with B and E that you wish to activate or deactivate the gauge mode. The gauge symbol starts flashing.
3. By bridging contacts B and + or B and – the gauge mode is switched on and off.
4. Confirm your settings with B and E.



Without confirmation the display will disappear after 3 minutes and your entries will not be accepted.

### Diving in gauge mode

The following information is displayed in gauge mode:

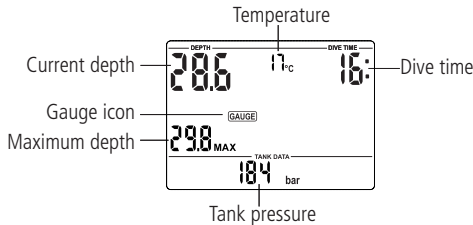

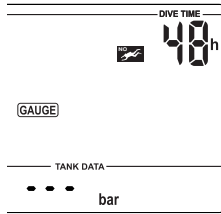
**After diving in gauge mode**

Smart Z shows the remaining time span during which it cannot be used in computer mode. Once the waiting period is over, the gauge mode can be switched off manually ->26.

The no-fly time after diving in gauge mode is 48 hours.

Desaturation time will not be displayed.

## V Diving with microbubble levels (MB)



The following chapter deals with the characteristics of diving with microbubble levels (MB levels). For general information about displays and features of diving with Smart Z see chapter III.

**Microbubbles** are tiny bubbles that can build up inside a diver's body during any dive and normally dissipate naturally during an ascent and on the surface after a dive. Dives within no-stop time and observation of decompression stops do not prevent the formation of microbubbles in the venous blood circulation.

Dangerous microbubbles are those migrating into the arterial circulation. The reasons for the migration from the venous blood circulation to the arterial circulation can be a great many microbubbles collecting in the lungs. UWATEC has equipped Smart dive computers with a new technology to protect from microbubbles.

The diver chooses – according to his/her needs – an MB level and influences through it the level of protection from microbubbles. Diving with MB levels requires additional ascent stops (level stops), the ascent is slowed down and the body gets more time to desaturate. This works contrary to the formation of the microbubbles and increases the safety.

Smart Z features **6 microbubble levels (L0-L5)**. Level L0 corresponds to UWATEC's well-known decompression model ZH-L8 ADT and does not require level stops due to microbubble formation. Levels L1 to L5 offer additional protection from microbubble formation with level L5 offering the highest protection.

Similar to the display of information during decompression dives or dives within no-stop time, Smart Z displays depth and duration of the first level stop as well as the total time of ascent as soon as the MB no-stop time has run out. As the MB no-stop time is shorter than the ordinary no-stop time a diver will be required to carry out a stop (level stop) sooner than a diver using level L0.

If a diver ignores a required level stop, Smart Z will change over to a lower MB level and the dive can not be completed with the initially chosen MB level. E.g. If a diver sets level L4 on Smart Z prior to the dive and during the dive ignores the stops recommended Smart Z will automatically adjust the setting to level L3 or lower.

### 1 Comparison of dives with MB level L0 and MB level L5

When two Smart Zs are used simultaneously, one unit is set for example to MB level L5, the other to L0, the no-stop time will be shortened and level stops will be required before the diver has the obligation of a decompression stop. These additional level stops help dissipate the microbubbles.

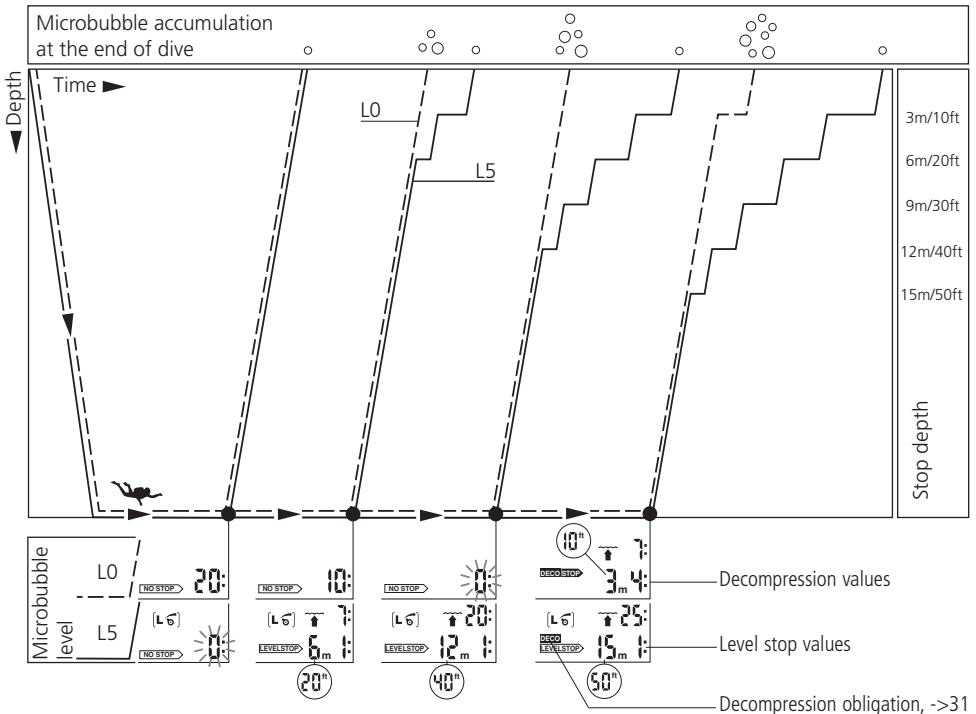

This chapter will exclusively deal with terminology and display features used while diving with MB levels. All other features are described in chapter III (page 15).

2.1 Display during microbubble (MB) no-stop phase

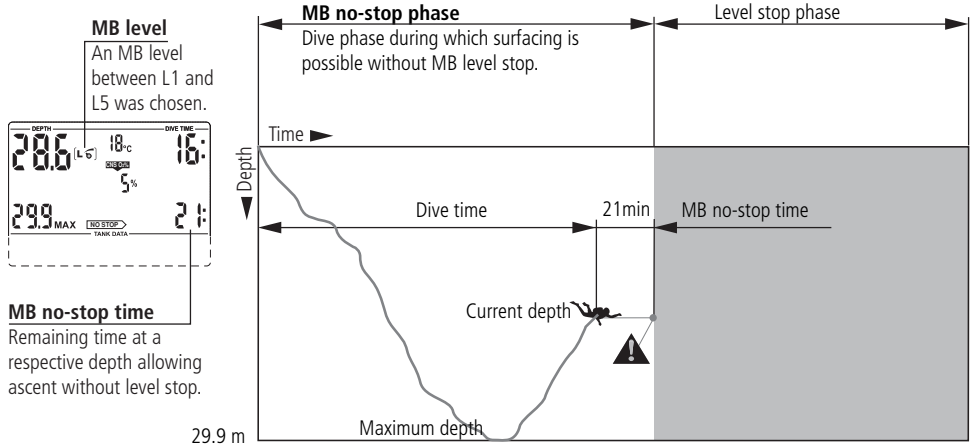

2.2 Display during level stop phase

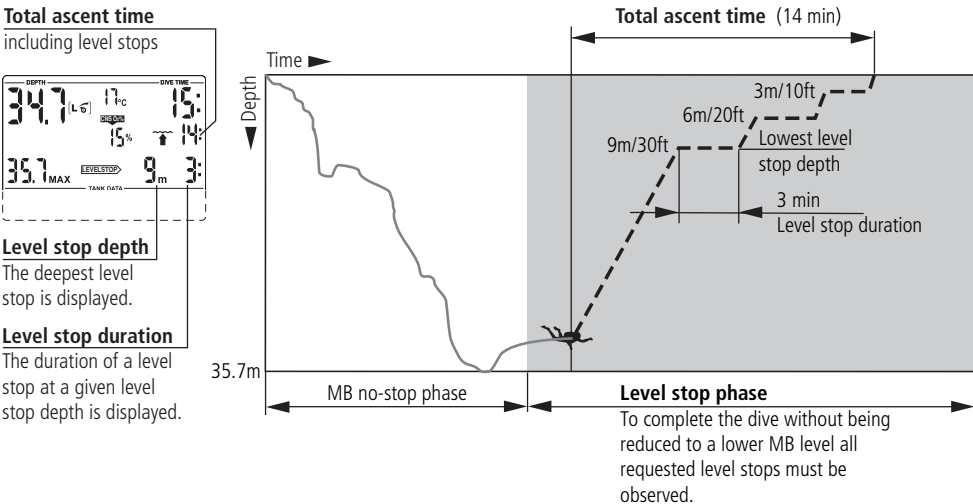

## 3 Preparation for a dive with microbubble levels (MB levels)

### 3.1 Setting the MB level

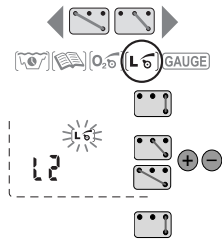

To change the MB level Smart Z must be in user mode.

1. Bridge contacts B and + or B and – until the symbol for MB levels appears.
2. Confirm that you wish to change the displayed MB level by bridging B and E.
3. Change MB level by bridging contacts B and + or B and – .
4. Confirm with B and E the selected MB level.

Without confirmation the display will disappear after 3 minutes and your entries will not be accepted.

Smart Z will display the (L0) symbol to confirm that an MB level beyond L0 (L1-L5) has been chosen. If however a level stop is ignored, the new MB level is permanently shown (->31).



MB levels have an influence on the dive planner.

## 4 Functions during the dive with microbubble levels

### 4.1 Level stop information

#### Microbubble (MB) no-stop time

While diving with MB levels L1 to L5 Smart Z will display the MB no-stop time instead of the ordinary no-stop time. Within the MB no-stop time no level stops are required.

The arrow (NO STOP) and the MB level symbol (L0) are visible. The remaining MB no-stop time is shown in minutes.

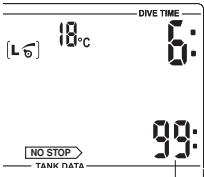

MB no-stop time



- Information and alarms for MB no-stop time and ordinary no-stop time are the same (->22).
- Regardless of the MB level, we generally recommend to perform a slow ascent during the last few metres / feet.

#### Level stop

Level stop icon

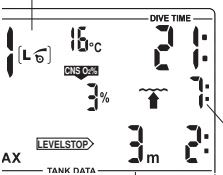

Deepest level stop depth  
Level stop duration

Total ascent time

On entering the level stop phase, the arrow (NO STOP) disappears and the arrow (LEVELSTOP) appears. The (LEVELSTOP) arrow flashes for 8 seconds and an audible attention beep goes off. To complete the dive without being reduced to a lower MB level, all requested level stops must be observed.

To the right of the (LEVELSTOP) arrow, the deepest level stop is displayed in metres/feet. The display "3m 2:" ("10ft 2:") means that a level stop of 2 minutes at a depth of 3 metres (10ft) has to be observed.

When a level stop obligation is finished, the next higher level stop – if present – is displayed. When all level stops have been observed, the arrow (LEVELSTOP) extinguishes and the arrow (NO STOP) reappears. The indication of time shows the MB no-stop time again.

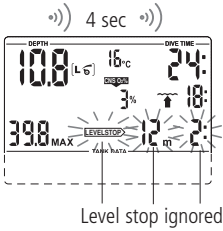

**WARNING**

The attention message "**Level stop ignored**" is activated if the requested level stop is not observed. An attention beep\* goes off, the arrow **LEVELSTOP**, the depth and duration of the ignored level stop begin flashing.

To complete the dive without being reduced to a lower MB level, you must descend to the prescribed depth immediately!

Microbubble level reduced

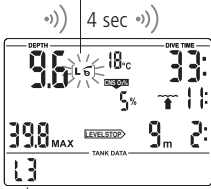

**WARNING**

The warning "**microbubble level reduced**" is activated if the diver ascends more than 1.5m (5ft) above the required level stop. Smart Z reduces the microbubble level, an attention beep\* goes off and for the rest of the dive the new MB level is indicated in the position of O<sub>2</sub> % mix. The level stop for the reduced MB level is now displayed.

To complete the dive without being further reduced to an even lower MB level the new level stop must be observed.

New microbubble level



\* Attention beeps can be suppressed via SmartTRAK.

#### 4.2 Total time of ascent

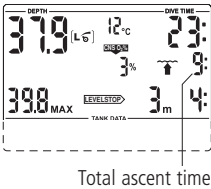

Smart Z displays the level stop information and the total time of ascent. This includes the time of ascent as well as all level stops.



The total time of ascent is calculated on the basis of the prescribed ascent rate and a normal workload. Total time of ascent can be subject to change if the ascent rate is not ideal (100%) or if Smart Z detects a higher workload.

#### 4.3 Decompression obligation

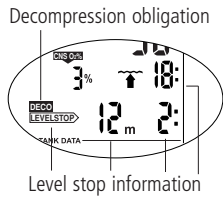

**WARNING**

Avoid decompression dives when diving with MB levels.

Smart Z calculates and displays level stops to reduce microbubble formation, but it also calculates the diver's decompression data. If decompression stops become obligatory, the **DECO** symbol will be displayed. The total ascent time will now also contain a decompression stop.

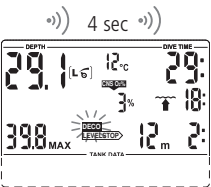

**WARNING**

You are close to entering decompression: At the beginning of a decompression phase an attention beep goes off and the **DECO** symbol flashes for 8 seconds.

In order to prevent a dive with long decompression stops it is recommended that you ascend a few metres/feet on seeing this message.

## 4 Functions during the dive with microbubble levels

### 4.4 Level stop and deco stop

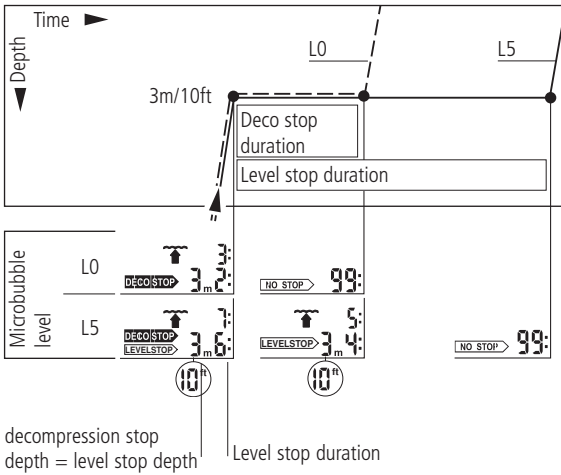

When the level stop depth equals the depth of the first obligatory decompression stop and if you are within 1.5m/5feet of the stop depth itself, Smart Z shows **DECO STOP** and **LEVEL STOP**. The indicated duration refers to level stop duration.

Since level stops are more restrictive than decompression stops, when all decompression obligations have been observed the display changes from **DECO STOP** **LEVEL STOP** to **LEVEL STOP** only.

## 5 Complete a dive with MB levels

A dive with MB levels is completed the same way as a dive without MB levels (L0) (-> 24), save for the following exceptions:

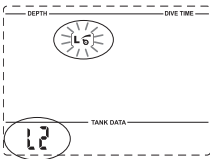

If the MB level has been reduced during the dive, Smart Z will display a flashing MB level symbol and the current MB level for five minutes after reaching the surface. The dive is then completed and Smart Z changes to user mode with the MB level switching back to the original MB setting.

Repetitive dives and microbubble levels: If during a dive a level stop is being ignored and the diver starts another descent shortly afterwards, Smart Z might immediately request level stops. To complete the dive with the initially set MB level all level stops must be observed.





Smart Z has a dive planner which allows the planning of no-stop dives as well as decompression dives with freely determinable surface intervals.

Basis of the planning:

- selected fraction of oxygen and MOD
- selected microbubble level
- water temperature of the most recent dive
- altitude range (if any)
- status of saturation at the time the dive planner is selected
- assuming a normal workload of the diver and observance of the prescribed ascent rates



If two or more divers using computers are planning a dive, planning for all divers has to be based on the dive computer showing the shortest no-stop times. Failure to do this may lead to serious injury or death from decompression sickness.

### 1 Planning a no-stop dive



With the contacts B and + or B and – you can select the dive planner at the surface. (The dive planner cannot be selected in gauge mode)

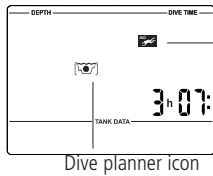

The microbubble warning and its duration are displayed if Smart Z detects an increased risk due to the accumulation of microbubbles.

Duration of the warning

Enter the dive planner with B and E.

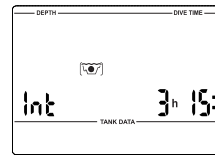

The input window for the time interval is displayed if there was a remaining desaturation (DESAT) before the Dive Planner has been selected. This surface interval between now and the beginning of the dive can be changed with the contacts B and + or B and – in steps of 15 minutes.

Input of the surface interval

If a microbubble warning (no dive) and its duration has been displayed, Smart Z proposes this time – rounded up to the next 15 minutes – as surface interval. If the proposed interval is shortened, the microbubble warning appears.

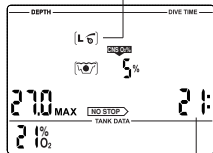

No-stop time or MB no-stop time

With B and E you confirm the displayed interval (if applicable), then Smart Z starts scrolling the no-stop times. The no-stop times are displayed in 3 metre increments (10 ft) and are displayed for every increment for about 2 seconds. The process starts at 3 metres (10 ft).

If a microbubble level has been selected (L1-L5), the MB no-stop time is shown.

No-stop times will be displayed as long as the selected maximum operating depth (MOD) is not exceeded.

On page 24 you will find further information and safety considerations regarding the microbubble warning.

## 2 Planning a decompression dive

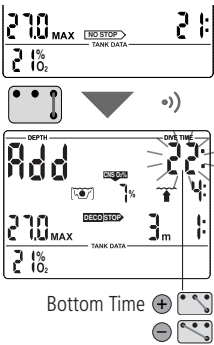

1. Activate the dive planner for a no-stop dive ->33.
2. Wait until the desired depth appears, then switch into decompression planning by bridging contacts B and E. Smart Z shows the bottom time (no-stop time + 1 minute) and the appropriate decompression information or level stop data respectively.
3. "Add" asks that you set the bottom time. This is done with contacts B and +, B and - respectively. As soon as the contacts are no longer bridged, Smart Z calculates the decompression information or level stop data respectively for this set bottom time.

If you wish to plan a decompression dive at another depth, switch from decompression planning to no-stop planning by means of B and E. Smart Z again shows the scrolling no-stop times. Now you can switch between no-stop planning and decompression planning at will with contacts B and E.

If the calculated decompression information and the total ascent time exceed 99 minutes, or the CNS O<sub>2</sub>% value exceeds 199%, the said values will start flashing on the display or "--" values appear and the decompression calculation is suspended until the bottom time has been reduced accordingly. CNS O<sub>2</sub>% values higher than 199% will be displayed as 199 %.

## 3 Leaving the dive planner

With the contacts B and E (1-2 sec) you can exit the Dive Planner. This also occurs after three minutes without operation.

1 Survey

A dive is entered in the logbook if the dive time is longer than 2 minutes. Smart Z records the profiles of about 100 hours of diving. This information can be transferred to a PC with the standard infrared interface (IrDA) and the Windows® software SmartTRAK. Up to 99 dives can be displayed directly on the dive computer.

The following information of the dive is displayed:

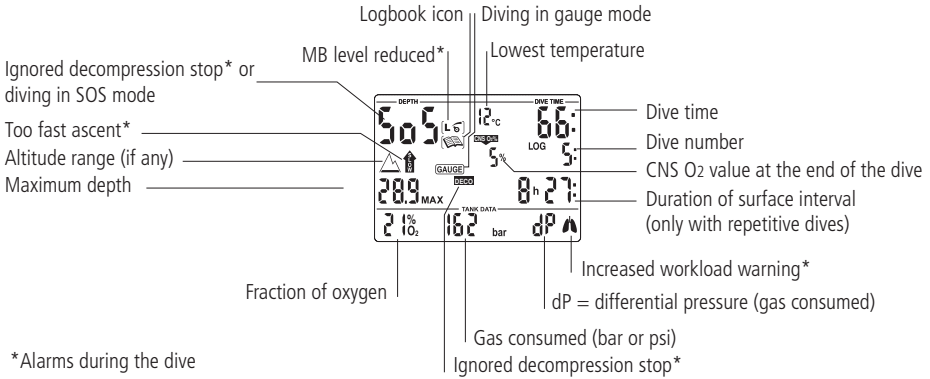

If a dive is started within adaptation time (after a change of altitude), the adaptation time is displayed instead of the surface interval.

2 Operation



With the contacts B and + or B and – you can select the logbook. With B and E you enter the logbook.

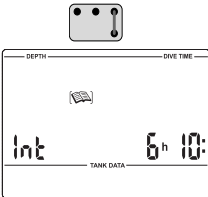

If there was a remaining desaturation time (DESAT) before selecting the logbook, the time since the last dive (surface interval) is displayed.

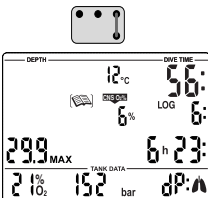

With B and E you get the most recent dive displayed (LOG 1).

Each bridging of B and + or B and – causes a jump to the next older or more recent dive. Upon continuous bridging of the contacts all dives are displayed successively.

With the contacts B and E you can exit the logbook. The logbook closes automatically after 3 minutes without operation.

## VIII Appendix

### 1 Technical information

- Operating altitude:** with decompression information: sea level up to approx. 4000 m (13120ft); w/o decompression, w/o RBT information: usable in gauge mode (at any altitude)
- Max. displayed depth:** 120m (395 ft), resolution between 0.8 m and 99.9 m: 0.1 m, >99.9 m: 1m  
The resolution in feet is always 1 foot.



- Do not dive deeper than the limits given by the chosen fraction of oxygen (nitrogen narcosis, oxygen toxicity).
- Never dive deeper than your training qualification (experience) allows you.
- Always observe local dive depth restrictions.

**Decompression calculation depth range:** 0.8 to 120m (3 to 395 ft)

**Maximum environment pressure:** 13 bar (189 psi)

**Clock:** Quartz timer, display up to 199 minutes.

**O<sub>2</sub>% Mix:** Adjustable between 21%O<sub>2</sub> (compressed air) and 100% O<sub>2</sub>

**Operating temperature:** -10° to +50°C (14°F to 122°F).

**Power supply:** Special battery UWATEC LR07

**Life of the battery:** 500 to 800 dives, depending on the quantity of dives per year and the use of the backlight.

**Transmitter:** **High pressure connection:** Maximum working pressure: 300 bar (4350 psi)  
**Life of the battery:** up to 1000 dives, max. 3 years without use.

**Power supply:** User replaceable battery CR2450

### 2 Maintenance

The tank pressure gauge and the parts of this product used to measure the tank pressure should be serviced by an authorized SCUBAPRO UWATEC dealer every second year or after 200 dives (whichever comes first). Aside from that your Smart Z is virtually maintenance free. All you need to do is to rinse it carefully with fresh water after each use and to have the batteries changed when needed. To avoid possible problems with your Smart Z, the following recommendations will help assure that it will give you years of trouble free service:



- Avoid dropping or jarring your Smart Z.
- Do not allow your Smart Z to be exposed to direct, intense sunlight.
- Rinse your Smart Z thoroughly with fresh water after each dive.
- Do not store your Smart Z in a sealed container; make sure there is free ventilation.
- If there are problems with operating the contacts, use soapy water to clean Smart Z and dry it thoroughly. The surface of your Smart Z housing can be treated with silicone grease. Do not apply grease to the water contacts!
- Do not clean Smart Z with liquids containing solvent (apart from water).
- If the service icon appears, Smart Z must not be used for any further dives. Take your dive computer to an authorized SCUBAPRO UWATEC dealer.



Take the dive computer to an authorised SCUBAPRO UWATEC dealer in order to change the batteries. The battery replacement is carried out by a SCUBAPRO UWATEC subsidiary. Smart Z is checked for its technical integrity at the same time. Do not attempt to have the batteries changed by anyone other than an authorised SCUBAPRO UWATEC dealer.

#### 2.1 Replacing the battery of the transmitter



It is recommended to have the battery of the transmitter replaced by an authorized SCUBAPRO UWATEC dealer. The change must be made with particular care in order to prevent water from seeping in. The warranty does not cover damages due to an improper replacement of the battery.

**Transmitter battery set (PN 06.201.920):** Includes a Type CR 2450 battery and a 26.00 x 2.00 mm transmitter cap o-ring.

**WARNING**

Never touch the metal surface of the battery with bare fingers. The two battery poles must never be short circuited.

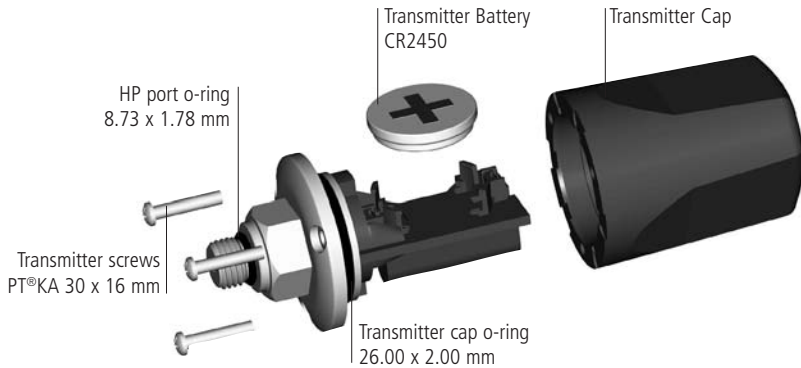
**Procedure:**

To replace the battery you need a Phillips screwdriver and a clean cloth.

**WARNING**

- A leaking transmitter cap may lead to the destruction of the transmitter by water seeping in or cause the transmitter to switch off without prior notice.
- Always open the transmitter in a dry and clean environment.
- Only open the transmitter to replace the battery.

1. Remove the transmitter from the HP outlet of the first stage of the regulator.
2. Dry the transmitter with a soft towel.
3. Remove the 3 screws with the Phillips screwdriver.
4. Remove the transmitter cap carefully.
5. Remove the transmitter cap o-ring carefully. Do not damage the sealing surfaces.
6. Remove the battery by holding it on both sides. Do not touch the contacts or electronic parts.



Protect the environment and dispose the battery properly.

**WARNING**

If you notice traces of seeping water, damages, or other defects on the o-ring, do not use the transmitter for further dives. Take it to an authorized SCUBAPRO UWATEC dealer for check and repair.

7. Always insert a new o-ring when you replace the battery and dispose the old o-ring. Make sure that the new, lubricated o-ring is in perfect condition, and that o-ring, o-ring groove and the sealing surfaces of HP outlet and transmitter cap are free of dust and dirt. If necessary, clean the parts with a soft cloth. Fit the o-ring in the o-ring groove.

**WARNING**

8. Check the proper polarity of the battery. The transmitter can be damaged if you do not insert the battery correctly.

Wait for at least 30 seconds. Now insert the new battery, with "+" pointing upwards, into the battery compartment.

9. After battery replacement the transmitter will perform an automatic test and switch into ready mode after 60 seconds.

**WARNING**

10. The transmitter cap will only fit in *one* position. Check the proper position of the guide slots on the electronic support and in the transmitter cap.

Slide the transmitter cap carefully back into its proper position.

11. Do not overtighten the screws! Fasten the transmitter cap with the 3 screws.
12. Mount the transmitter on the HP outlet of the first stage of the regulator and check transmission and pairing. If you do not receive valid tank pressure data, transmitter and dive computer must be paired again.

### 3 Conversion of tank pressure

Tank pressure indicated may differ from the information given by a manometer/pressure gauge. Smart Z displays pressure always converted to a temperature of 20°C / 68°F, whereas the mechanical pressure gauge displays the current pressure influenced by temperature.

The figure below allows you to compare the information given by a conventional pressure gauge and by Smart Z at six different temperatures.

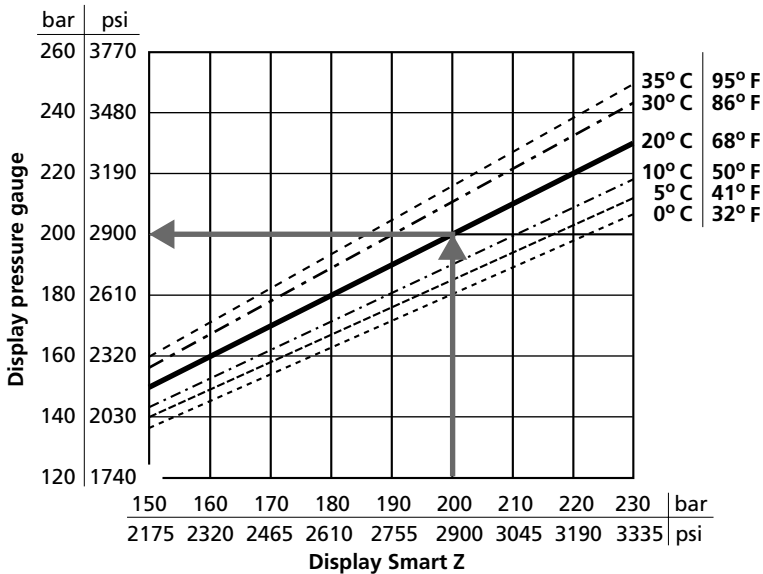

### 4 Warranty

The warranty only covers dive computers which have been bought from an authorised SCUBAPRO UWATEC retailer.

The warranty is given for a period of two years.

Repairs or replacements during the warranty period do not increase the warranty period.

In order to put forward a warranty claim: send the dive computer together with a dated receipt of the purchase to your authorised retailer or an authorised servicing point.

UWATEC reserves the right to determine the merits of a warranty claim and to determine whether the computer will be repaired or replaced.

Excluded are faults or defects due to:

- excessive wear and tear;
- exterior influences, e.g. transport damage, damage due to bumping and hitting, influences of weather or other natural phenomena;
- servicing, repairs or the opening of the dive computer by anybody not authorised by the manufacturer. This especially concerns the change of battery;
- pressure tests which do not take place in water;
- diving accidents;
- improper placement of the transmitter cap.

## 5 FCC

This device complies with part 15 of the FCC Rules. Operation is subject to the following two conditions: (1) This device may not cause harmful interference, and (2) this device must accept any interference received, including interference that may cause undesired operation.

## 6 Index

Active backlight _____	11	Mounting the transmitter to the first stage ____	12
Ascent rate _____	15, 17, 19, 20	Nitrox _____	16
Battery alarm _____	17	No-stop time _____	15, 22, 28
Battery capacity, Checking the... _____	10	O <sub>2</sub> % mix, Set up... _____	18
Battery lifetime _____	36	O <sub>2</sub> fraction _____	15, 16, 18
Beep, Switch off the... _____	17	O <sub>2</sub> partial pressure _____	16, 17, 20
		O <sub>2</sub> partial pressure, maximum _____	16, 18, 20
CNS O <sub>2</sub> _____	15, 16, 17, 21, 35	O <sub>2</sub> toxicity _____	15, 16, 17, 21, 35
Deco data during decompression phase _____	15	Operating Smart Z _____	4, 8, 9
Deco data during no-stop phase _____	15	Oxygen..., see "O <sub>2</sub> ..."	
Decompression stop, Ignored... _____	17, 23	PC, transfer to PC (logbook) _____	8, 35
Depth, current _____	19	ppO <sub>2</sub> , see O <sub>2</sub> partial pressure	
Desaturation time _____	24	Premix, setting the gas mixture _____	18
Dive _____	15	RBT _____	15, 17, 22
Dive planner _____	33	Setting the MOD _____	18
Dive time _____	19	SmartTRAK _____	8, 9, 16, 17, 35
Dive, end of a dive _____	24	SOS mode _____	11
Fly, "no-fly time" _____	10, 24	Surface interval _____	33, 35
Gas mixture, Setting... _____	18		
Gauge mode _____	26	System _____	8
Light _____	11	Tank pressure _____	21
Logbook _____	35	Technical information _____	36
Maintenance _____	36	Transmitter _____	8, 12, 36
Maximum depth _____	19, 35	Warnings _____	17
Microbubbles _____	28	Workload _____	21
Microbubbles, Warning of... _____	24, 33	Workload, Increased... _____	21
Mountain lakes, Diving in... _____	25, 35		

### **SCUBAPRO UWATEC Americas**

(USA/Canada/Latin America)

1166 Fesler Street  
El Cajon, CA 92020 USA  
t: +1 619 402 1023  
f: +1 619 402 1554  
[www.scubapro.com](http://www.scubapro.com)

### **SCUBAPRO UWATEC Asia Pacific**

1208 Block A, MP Industrial Center  
18 Ka Yip St.  
Chai Wan Hong Kong  
t: +852 2556 7338  
f: +852 2898 9872  
[www.scubaproasiapacific.com](http://www.scubaproasiapacific.com)

### **SCUBAPRO UWATEC Australia**

Unit 21, 380 Eastern Valley Way  
Chatswood, N.S.W. 2067  
t: +61 2 9417 1011  
f: +61 2 9417 1044  
[www.scubapro.com.au](http://www.scubapro.com.au)

### **SCUBAPRO UWATEC Deutschland**

(Germany / Austria / Scandinavia)  
Taucherausrüstungen GmbH  
Rheinvogtstraße 17  
79713 Bad Säckingen-Wallbach  
t: +49 (0) 7761 921050  
f: +49 (0) 7761 921051  
[www.scubapro.de](http://www.scubapro.de)

### **SCUBAPRO UWATEC Italy**

Via G.Latiro 45  
I-16039 Sestri Levante (GE)  
t: +39 0185 482 321  
f: +39 0185 459 122  
[www.scubapro-uwatec.it](http://www.scubapro-uwatec.it)

### **SCUBAPRO UWATEC Japan**

4-2 Marina Plaza 5F  
Kanazawa-Ku  
Yokohama  
Japan  
t: +81 45 775 2288  
f: +81 45 775 4420  
[www.scubapro.co.jp](http://www.scubapro.co.jp)

### **SCUBAPRO UWATEC France**

Les Terriers Nord  
175 Allée Belle Vue  
F-06600 Antibes  
t: +33 (0) 4 92 91 30 30  
f: +33 (0) 4 92 91 30 31  
[www.scubapro-uwatec.com](http://www.scubapro-uwatec.com)

### **SCUBAPRO UWATEC Benelux**

Avenue des Arts, 10/11 Bte 13  
1210 Bruxelles  
t: +32 (0) 2 250 37 10  
f: +32 (0) 2 250 37 11  
[www.scubapro-uwatec.com](http://www.scubapro-uwatec.com)

### **SCUBAPRO UWATEC España**

Pere IV, nº359, 2º  
08020- Barcelona  
t: +34 93 303 55 50  
f: +34 93 266 45 05  
[www.scubapro-uwatec.es](http://www.scubapro-uwatec.es)

### **SCUBAPRO UWATEC U.K.**

Vickers Business Centre  
Priestley Road  
Basingstoke, Hampshire RG24 9NP  
England  
t: +44 0 1256 812 636  
f: +44 0 1256 812 646  
[www.scubapro.co.uk](http://www.scubapro.co.uk)

### **SCUBAPRO UWATEC Switzerland**

Oberwilerstrasse 16  
CH-8444 Henggart  
t: +41 (0) 52 3 16 27 21  
f: +41 (0) 52 3 16 28 67  
[www.scubapro.de](http://www.scubapro.de)

[www.uwatec.com](http://www.uwatec.com)



Protect the environment!  
When disposing of this  
computer, do so in an  
environmentally friendly way.



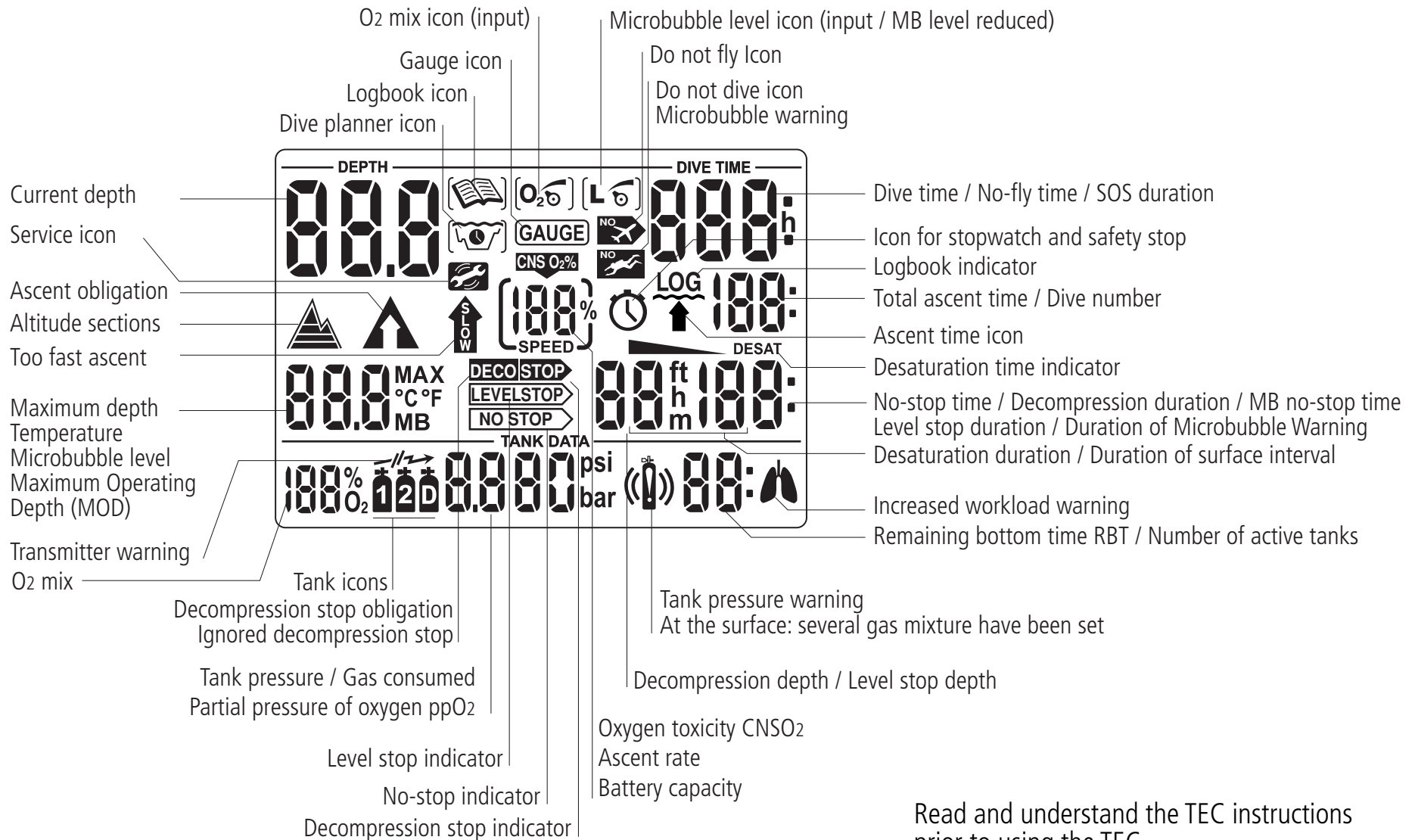

# Quick reference Smart TEC









Read and understand the TEC instructions prior to using the TEC.

# Operating scheme Smart TEC

-  Start / Confirmation / Enter
-  + / Navigate
-  - / Navigate

On the surface TEC switches off automatically after 3 minutes without operation.

-  Select (press) and confirm (press and hold) gas mixtures
-  Activate the timer for safety stops (dive mode only, in depths < 6.5 m / 20 ft) (press)
-  Operate the stopwatch (gauge mode only) (press)
-  Set a bookmark (press)
-  Toggle between maximum depth > temperature > MB level > ... (press)
-  Intermediate time and reset (in gauge mode only and while stopwatch is active) (press)
-  Switching on the backlight (press and hold)

