



Galileo HUD pro User Manual



deep down you want the best

scubapro.com

GALILEO HUD USER MANUAL

The Galileo HUD Diving Computer – Designed for a revolution in diving.

Welcome to SCUBAPRO dive computers and thank you for purchasing the Galileo HUD. You are now the owner of an extraordinary partner for your dives. This manual provides you easy access to SCUBAPRO state-of-the-art technology and the HUD's key features and functions. Should you wish to know more about SCUBAPRO diving equipment, please visit our website www.scubapro.com



⚠ IMPORTANT

Before using your SCUBAPRO HUD, please carefully read and understand the Read First booklet that is included in the package.

⚠ WARNING

- The HUD has a depth rating of 120m/394ft.
- At depths between 115m/377ft and 120m/394ft in Dive mode the depth changes color and starts to blink, and at depths over 120m/394ft the HUD automatically switches to Gauge mode and cannot be used as a decompression computer for the remaining time of the dive.
- Diving at oxygen partial pressures higher than 1.6bar (corresponding to a depth of 67m/220ft when breathing compressed air) is extremely dangerous and could lead to serious injury or death.
- Never risk your life on only one source of information. Eventually, every computer has the potential to fail, so do not depend exclusively upon it and always have a plan for how to handle failures. Use a redundant dive computer, carry backup tables and depth/time instrumentation.

⚠ WARNING

The HUD is delivered in deep sleep mode. Charge and press the push-wheel to activate your HUD before the first dive.



The HUD dive instrument is a personal protective equipment in compliance with the essential safety requirements of the European Union Regulation 2016/425. RINA SpA, Via Corsica 12, I-16128 Genoa, notified body no. 0474, have certified its conformity with the European Standard EN 250: 2014 (EN 250: 2014 : Respiratory equipment – Open circuit self-contained compressed air diving apparatus – requirements, testing and marking);

The HUD dive instrument is also compliant with the European Union directive 2014/30/EU.

Standard EN 13319: 2000

The HUD dive instrument is compliant with the European standard EN 13319: 2000 (EN 13319: 2000 – Depth gauges and combined depth and time measuring devices – Functional and safety requirements, tests methods).

TABLE OF CONTENTS

1. INTRODUCTION TO THE HUD	6
1.1 Near Eye Technology	6
1.2 Mounting the HUD on your mask	7
1.3 Mounting the holder to the mask	7
1.4 Mounting the HUD to the holder	11
1.5 Switching on the HUD	14
1.6 The Surface screen	14
1.7 Power concept and charging	15
1.8 Operating modes	16
1.9 HUD push-wheel control	17
1.10 Basic settings	18
1.11 No-fly time	23
1.12 SOS	23
1.13 Mounting and pairing the high pressure transmitter	24
1.14 Turning off the HUD	27
2. HUD SETTINGS AND MENUS	28
2.1 Gas	29
2.1.1 Recreational (factory setting)	29
2.2 Navigation	30
2.2.1 Compass	31
2.2.2 GPS	31
2.3 Settings	32
2.3.1 Dive settings	33
2.3.2 Altimeter	39
2.3.3 Tank pairing	40
2.3.4 Compass	40
2.3.5 GPS	41
2.3.6 Display	42
2.3.7 System	43
2.4 Dive planner	46
2.5 Logbook	49
2.6 Communication	50
3. DIVING WITH THE HUD	50
3.1 Dive mode at surface	51
3.1.1 Recreational (factory setting)	51
3.1.2 Multi-gas (Nitrox)	51
3.1.3 Trimix	51
3.1.4 CCR	52
3.1.5 No-fly counter	52
3.2 Dive display information	52
3.2.1 Standard display	53
3.2.2 Dive display "lite"	54
3.2.3 Dive profile	54
3.2.4 Navigation	55
3.2.5 Deco stop table	56
3.3 Alarms and warnings during diving	56
3.3.1 Maximum depth	56
3.3.2 Dive time	56
3.3.3 No-stop time	56
3.3.4 CNS O ₂	57
3.3.5 Safety stop timer	57

3.3.6	RBT	57
3.3.7	Ascent rate	57
3.3.8	MOD/ppO ₂	58
3.3.9	Entering decompression	59
3.4	Diving with MB levels	60
3.4.1	Comparison of dives with MB level L0 and MB level L5	60
3.4.2	PDIS (Profile Dependent Intermediate Stop)	61
3.5	Altitude diving	64
3.5.1	Altitude warning after a dive	64
3.5.2	Prohibited altitude	64
3.6	Diving with nitrox	65
3.6.1	Technical diving	66
3.6.2	Diving with multiple gas mixtures	67
3.6.3	Diving with trimix	69
3.6.4	CCR mode	70
3.7	Gauge mode	74
3.8	Apnea mode	75
3.9	Navy mode	76
3.9.1	Operation – Switch screens	76
3.9.2	Settings	78
3.9.3	Diving in Navy mode	79
3.9.4	Operation – Switch off	80
4.	HUD ACCESSORIES	81
4.1	Safety lanyard	81
4.2	Additional mask mounts	81
4.3	Wireless high-pressure transmitter	81
4.4	Bluetooth USB stick	81
5.	INTERFACES FOR THE HUD AND AN INTRODUCTION TO LOGTRAK	82
5.1	Establishing communication	82
5.2	Interfacing with a PC/Mac or handheld device	83
5.2.1	Disk mode	83
5.2.2	Updating your HUD	84
5.2.3	Updating languages	84
5.2.4	Adding GPS waypoints	84
5.2.5	LOG and Bluetooth modes	84
5.2.6	Connecting the HUD with LogTRAK	85
5.2.7	Download dive profiles	85
5.2.8	Reading computer information	86
6.	TAKING CARE OF YOUR HUD	86
6.1	Technical information	86
6.2	Maintenance	86
6.3	Replacing the battery in transmitter	87
6.4	Warranty	88
7.	GLOSSARY	90
8.	INDEX	92

The HUD is a technologically-advanced heads up display dive computer designed to provide you with accurate depth, time, gas and decompression information.

Your HUD User Manual is divided into 6 main sections.

Introduction to the HUD. This section provides an overview of the HUD computer and describes how to mount the HUD to a mask, as well as its operating modes and main functions when on the surface.

HUD settings and menus. This section goes through the settings of your HUD.

Diving with the HUD. This section takes you underwater with the HUD, showing you how to use the HUD as a dive computer in both Open Circuit and Closed Circuit Rebreather diving scenarios. It outlines everything the HUD can—and will—do to enhance your safety and fun underwater.

HUD accessories. This section briefly describes the HUD's extras that you can purchase to get the most out of your dive computer in all conditions.

Interfaces for the HUD and an introduction to LogTRAK. This section describes how to download data, change settings, and manage your logbook.

Taking care of your HUD. This section illustrates how to take care of your new dive computer.

1. INTRODUCTION TO THE HUD

1.1 Near Eye Technology

The HUD is designed to be mounted on a diving mask in very close proximity to the human eye. A person with normal vision is able to focus on objects starting from a distance of approximately 20cm. Since the micro OLED screen of the HUD is positioned much closer than 20cm, specially developed optics are required to be able to read the screen clearly.

These multi-lens optics create an image of the micro OLED screen at a virtual distance of approximately 1m. This enables the diver to read the dive data on the screen and also maintain eye contact with his or her surroundings without having to continually adjust and readjust focus. (The size of this image is about 30x20cm², enabling it to be easily read by divers with normal vision.)

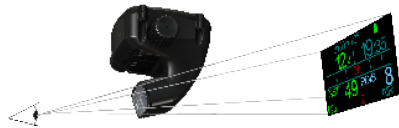

⚠ WARNING

- The HUD should never be used by divers who are unable to achieve the proper alignment of the HUD relative to their eye for optimal readability (see following section), or who in any way feel the positioning of the HUD negatively impacts their comfort at depth.
- Always test for proper readability before each dive, on the surface, and in a safe environment.
- If you have issues with your vision or experience optical problems of any kind, consult with your doctor before diving with the HUD. (Note: the HUD can be used with contact lenses or optical lenses.)
- Always carry a second dive computer as a backup.

1.2 Mounting the HUD on your mask

The HUD package includes a universal mask holder which is designed to be mounted on a dual-lens diving mask just above the right eye. There are also options available for mounting the holder to single-lens masks. These HUD holders attach to the mask with two cable ties (included).

 **NOTE:** There are also options available that enables you to mount the HUD directly to a SCUBAPRO mask.

You can find a list of compatible masks that a HUD can be mounted to with the universal holder at www.Scubapro.com.



1.3 Mounting the holder to the mask

The following parts are needed to mount the HUD to your mask. They are all included in your HUD package:

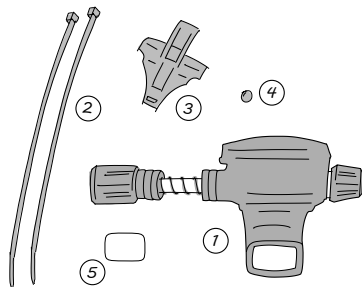

1. HUD
2. Cable ties
3. HUD holder
4. Ball
5. Protective foil

 **NOTE:** We recommend that you don't remove the blue display screen's protective foil until the assembly process is complete to avoid scratching the glass.

The following tools are needed to mount the HUD to your mask. They are not included in your HUD package:

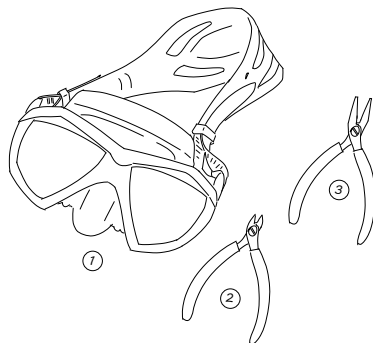

1. SCUBAPRO mask
2. Side cutters
3. Small pair of pliers

STEPS:

1. Place the HUD holder on your mask frame to check the positioning of the holder's tiny legs (see arrow).

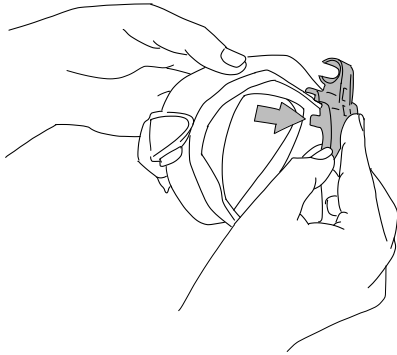

These legs stabilize the holder, preventing it from shifting horizontally.

NOTE: *The holder must be mounted correctly on the mask to ensure that the HUD is positioned correctly in your line of sight.*

2. Shorten the tiny legs as needed with the side cutters. Guide lines are provided on each leg edge to make sure legs are shortened in equal amounts.

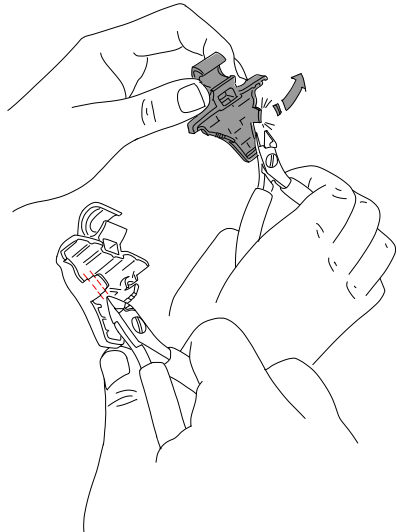

3. Once the legs are trimmed, re-check the fitment.

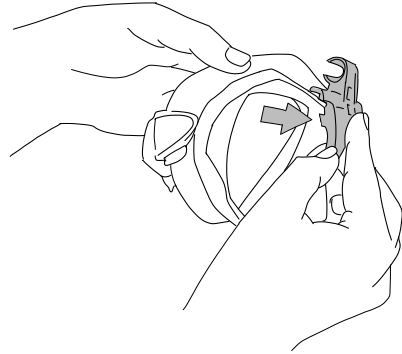

Repeat this step until proper fitment is achieved.

4. Starting from above the mask, thread the cable ties down between the hard plastic of the mask frame and the silicone, just above the nose pocket.

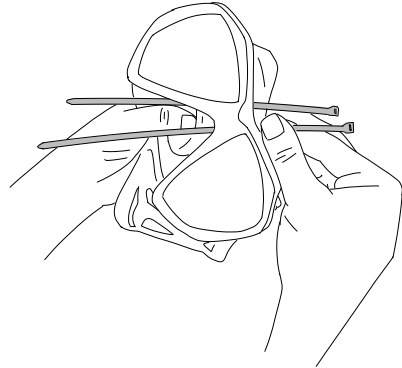

Direct one cable tie down the left side of the nose, and one down the right side of the nose. Once completed, double-check that the cable ties are properly routed.

 **NOTE:** The correct positioning of the heads of the cable ties -- knubbed side facing the inside of the mask, flat side facing outside -- is very important (refer to the top arrow in the next magnified picture.) If reversed, feeding the ends of the cable ties becomes difficult, and the positioning of the cable tie heads against the hard plastic frame can affect the proper fitment of the mask.

- While the next mounting step is not necessary for most SCUBAPRO masks, on a few mask models the small ball, included in the HUD's mounting parts list, can be used to even out the silicone in the area just above the nose, eliminating a possible pressure mark on your face. You can find out if your mask might benefit from the use of this ball by going to www.scubapro.com.

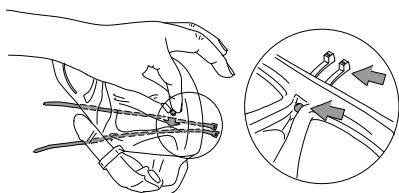

If your mask doesn't require the ball, proceed to Step 6. If it does, at this time insert the ball from the inside of the mask, above the nose pocket at its highest point, directly under the hard plastic frame. Press it into the silicone behind the cable ties. The cable ties should secure the ball and even out any excess silicone.

- Thread the cable ties through the holder from back to front. Hold the mask and holder in your hand like in the picture below. This hand position will also help you to hold the ball in place if you're using one.

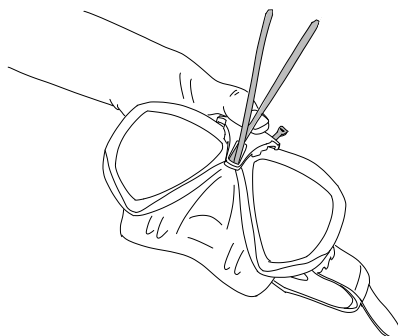

The holder has 2 slots, one above the other. The one you will use to thread your cable ties depends on your mask.

If the bridge of the nose aligns with the lower point, use the lower slot; if it is at a higher position, use the upper slot. Go to www.scubapro.com for more information on which slot is the best for your SCUBAPRO mask.

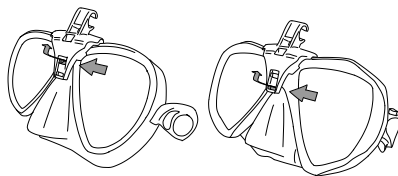

- Thread the cable ties through the slots (bending the ends a bit makes it easier to thread). Take care that the cable ties lie parallel to each other for appearances sake.

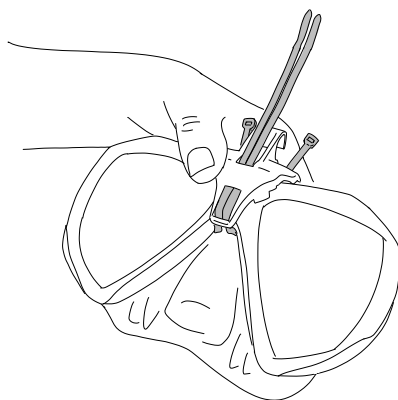

- Place the heads of the cable ties close to their final resting position over the hard plastic frame.

Thread the ends of the cable ties into the heads and pull tight in a vertical direction. If you're using the ball, take care that it stays in the correct position while tightening.

Pull the cable ties individually, alternating each equally. Take care that the heads of the cable ties stay in their final resting positions over the hard plastic frame while tightening. Both cable ties should be properly aligned, parallel to each other and as vertical as possible.

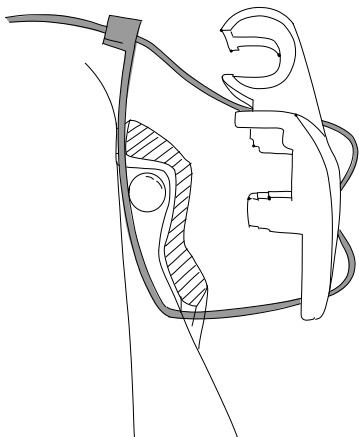

- Use the pliers for the final tightening. Pull in a vertical direction to avoid shifting the head of the cable tie. Check to make sure the holder is strapped tight and is stable and secure.

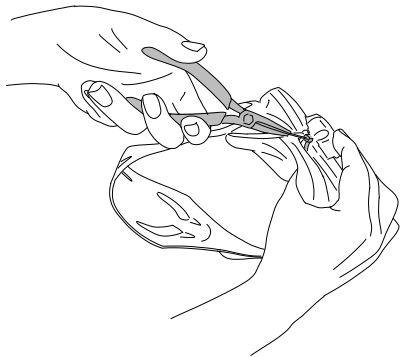

- Use the side cutter to shorten the cable ties. Cut off as much excess cable as possible, taking care the remaining ends are smooth and unable to penetrate the silicone.



NOTE: if you need to replace a cable tie, use one with the dimensions of .14x8in (3.5x200mm).

1.4 Mounting the HUD to the holder

The mounting/adjustment assembly on the HUD includes a hand wheel, a compression spring, 4 standard spacers and 1 locking spacer (with a flat spot in its inner circle), all arranged on the HUD's stainless steel post. The HUD is mounted to the holder's jaws.

STEPS:

1. For the initial mounting, unscrew the hand wheel to the point where enough of the stainless steel post (and spring) is exposed between the spacers to enable it to be inserted into the jaws of the holder.

At this point the HUD's mounting adjustment assembly might look something like this: closest to the HUD there would be 2 spacers, then an exposed length of post with compression spring, then 3 more spacers, and at the end, the hand wheel.

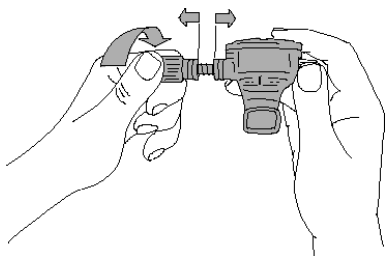

2. Insert the HUD into the holder and tighten the hand wheel. As you tighten the hand wheel the spacers will seat themselves into the indents in the holder's jaws.

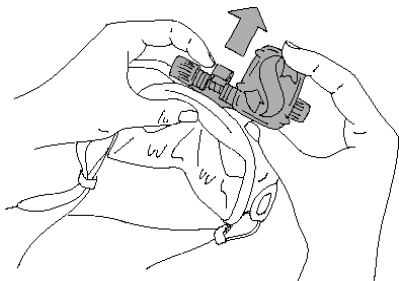

3. Rotate the HUD screen to where it can be viewed through the mask lens. Fix its position by further tightening the hand wheel.

4. Put on the mask just like you were preparing to go diving and check the position of the HUD screen. You want to be able to comfortably see the complete screen. If it is out of alignment with your line of sight, you'll need to make some adjustments.

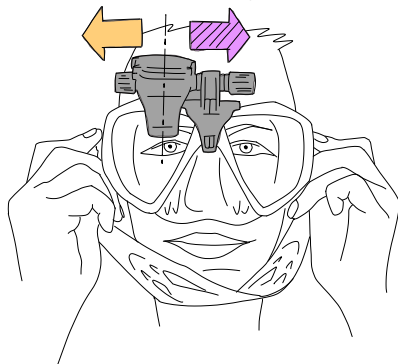

The sample in the picture shows that the HUD has to move to the right (purple arrow) in order to align with the diver's line of sight. That means the distance between the HUD and the holder needs to be reduced. This can be easily accomplished by shifting the position of the spacers.

(If the HUD has to be moved to the left – orange arrow – the shifting of spacers would be done in the opposite direction.)

5. Remove the HUD from the mask. Unscrew the hand wheel again, but this time remove it completely from the HUD mounting/adjustment assembly.

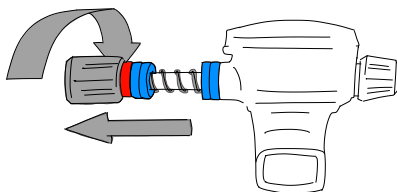

6. Remove the locking spacer (the one with the flat space in its hole), the first group of standard spacers, then the compression spring. This leaves the spacers closest to the holder.

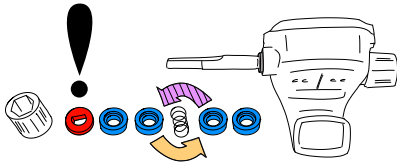

To reduce the distance between the HUD screen and the holder you would now remove one of these spacers.

☞ *NOTES: If you'll notice, the standard spacers are recessed on one side. This is so parts can be joined more efficiently. For example, the standard spacer closest to the HUD should have its recessed side facing the HUD. (Unless you don't need that spacer, in which case it's okay for the compression spring to be placed directly against the HUD.)*

Also, when possible, the standard spacers on either side of the compression spring should have their recessed sides facing the spring.

Finally, while it's okay to shift the spacers from one side to the other when making adjustments, never remove them permanently from the assembly. The HUD is designed to be used with all spacers at all times.

7. Replace the compression spring, slide on the standard spacers, then the locking spacer, and finally the hand wheel.

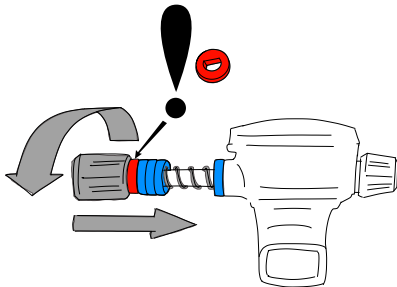

⚠ IMPORTANT

When replacing the hand wheel, make sure to thread it onto the post flat-side first (see #3 in next picture). This ensures that both the assembly and the hand wheel itself is secured with the hex nut located inside the hand wheel.

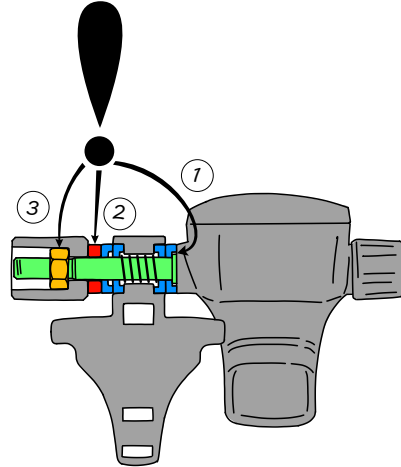

8. Remount the HUD like before and tighten down the hand wheel.

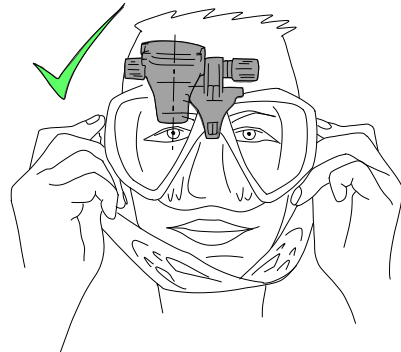

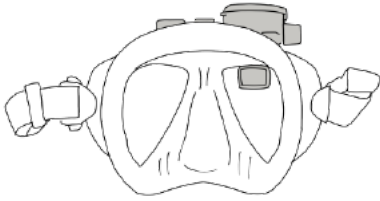

Put on the mask again and see if the HUD is now properly lined up. If not, repeat the described steps until the HUD sits perfectly in your line of sight.

The HUD can be tilted up and down for vertical adjustment to ensure optimal readability.

When not in use, the HUD can be conveniently flipped up, out of your field of view.



NOTE: A foggy mask lens limits visibility of the HUD display. Make sure to keep your mask lenses fog-free for maximum readability.

NOTE: When diving in depths 3m/10ft or shallower in locales where the sun is extremely bright, screen visibility might sometimes be reduced. Whether or not this becomes an issue depends on the positioning of the HUD screen relative to the sun.

NOTE: For some divers using the HUD for the first time, having the HUD positioned just above the right eye's line of sight takes some time getting used to. However, it doesn't take long for the left eye to start compensating for the small portion of the upper right lens occupied by the HUD, while the right eye is able to maintain close to full visibility, with the added benefit of having all dive data available with a simple upward glance. In no time you'll be diving without even noticing the HUD is there—until it's time to look up and check your dive data.

1.5 Switching on the HUD

Deep sleep mode

The HUD is delivered to you in a deep sleep mode. This is done to preserve battery life and ensure your HUD arrives with a fresh battery.

In order to switch on the HUD for the first time a power connection is needed. After this initial activation, the HUD will never again return to deep sleep mode.

The HUD is powered by a rechargeable Li-Ion battery. This battery must be fully charged before using the computer for the first time.

To charge the battery, first plug the power/USB cable into your HUD as shown in the picture below.



Now connect the other end of the cable to a USB charger, or a USB device capable of providing enough power to complete the charging process.

NOTE: If the HUD's battery is deeply discharged, nothing will appear on the display screen until the battery has reached a safe charge level for a startup. If this occurs, do not disconnect the USB, and do not try to activate the HUD by pressing a button. Simply leave the HUD charging for at least half an hour.

NOTE: Please keep the HUD clean to avoid scratches, dirty contacts or a sticking plug.

To switch on the HUD, press-and-release the push-wheel.

1.6 The Surface screen

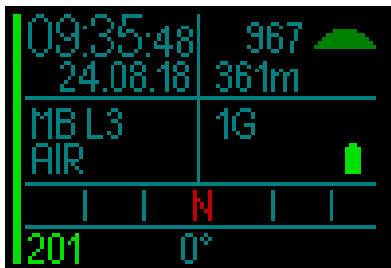

The HUD's Surface screen provides the following information:

Left side of screen:

- Time
- Date
- Microbubble (MB) Level
- Gas

Right side of screen:

- Ambient pressure in mbar (accompanied by the following symbols)



>970 mbar



970 to 870 mbar



<870 mbar

- Current altitude in meters/feet
- Number of gases set
- Battery level

Bottom of screen:

- Compass
- Transmitter Pairing Status (if active)

1.7 Power concept and charging

When connected to power, the battery symbol in the display appears in black/gray.

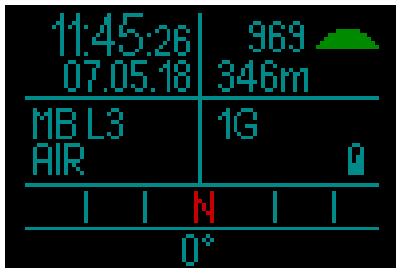

As the HUD becomes fully charged the battery symbol switches from black/gray to full gray.

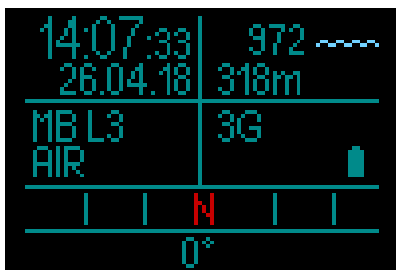

After removing the power cable the battery icon switches to green.

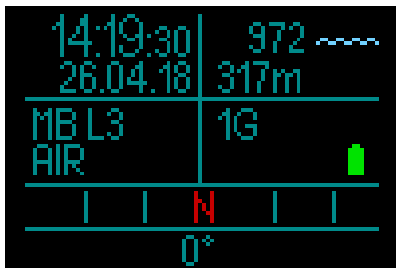

If left alone during the charging phase, the HUD will switch to sleep mode. But it is still charging.

The HUD will alert you when the battery is approaching a critical discharge level by displaying the following yellow battery symbol.

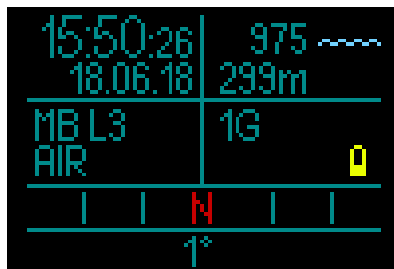

⚠ WARNING

Starting the dive with a weak battery may lead to a situation where the HUD switches off during the dive. In case of such an event you should always carry a backup instrument that will enable you to complete the dive safely. If the HUD switches off during a dive it will store the dive information in the logbook but remain switched off until you connect it to a USB charging device.

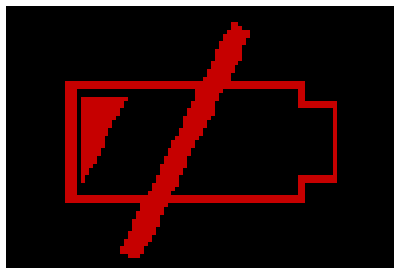

👉 **NOTE:** If your HUD shuts off during a dive due to low battery power, when you return to the surface and plug in the charging cable to restart, your HUD will be locked in Gauge mode for 48 hours. Never start a dive during this time because the decompression information from the previous dive will not be available.

WARNING

During a dive, when the battery indicator starts flashing red, the display will switch off automatically to save energy. However, you can still check the display manually by pressing the push-wheel.

WARNING

The HUD will not start a dive if the battery has reached the critical discharge level indicated by the yellow battery symbol. In this state the HUD cannot be used for diving.

WARNING

Dirt on any contact surfaces may increase the electrical resistance and burn/harden the dirt so that it is difficult to remove afterwards. To enjoy trouble-free operation and a long service life, clean the connection contacts on the HUD, located on the underside of the casing just above the screen, before charging.

WARNING

Rinse the HUD in fresh water after each dive and dry it thoroughly before charging. Pay particular attention to the area around the charging contacts.

WARNING

When your HUD's battery reaches the end of its lifetime, it can only be replaced by an authorized SCUBAPRO service center. Do not open your HUD or try to replace the battery yourself!

 *NOTE: Storing the HUD with a low battery may lead to a deep discharge state, which shortens the life of the battery. Therefore, it is recommended that you always charge the HUD before storing. Also, make it a habit to charge the battery every six months or so, even if you're not using the HUD. This will help maintain the battery and extend its useful life.*

1.8 Operating modes

The HUD has 4 operating modes (in addition to the deep sleep mode):

- 1. Charging and USB communication mode.** When connected to a USB device the HUD's battery automatically starts charging. At the same time, you can access either the flash memory or the logbook using the LogTRAK program.
- 2. Sleep mode.** In this mode the display is off, but the HUD still updates desaturation and monitors ambient pressure for altitude changes, etc. This mode is activated automatically at the surface after 5 minutes without operation.
- 3. Surface mode.** After a dive or when manually activated, the display is on and you can change settings or operate the HUD with its push-wheel. The Bluetooth interface can also be activated in this mode.
- 4. Dive mode.** This mode is activated when the computer reaches a depth of 0.8m/3ft or more. In this mode the HUD monitors depth, time, temperature and wireless sensors. Decompression calculations are performed in this mode.

1.9 HUD push-wheel control

The HUD operates with an intuitive push-wheel that allows you to access and control HUD functions with only one hand and without having to look to see what that hand is doing.

- To operate the wheel, simply rotate it to toggle from the Surface screen to the GPS screen, to navigate up and down within a menu, or to increase or decrease a user setting.
- To enter or exit a menu or to set user parameters you would press the end of the push-wheel.
- There are 2 methods for pushing the HUD push-wheel control: a press-and-release, and a press-and-hold.
- A press-and-release turns on the HUD, takes you to the main menu, lets you enter the various sub-menus and lets you select functions and save settings.
- A press-and-hold allows you to return to the previous menu or screen, edit settings, and from the Surface screen turn the HUD off.
- Press-and-release and press-and-hold functions can change based on what menu or operational mode you're currently in. To avoid confusion, at the bottom of each screen you'll see reminders of what each push function does on that particular screen. (The "short" arrow indicates the press-and-release function for that screen, while the "long" arrow indicates the press-and-hold function.)

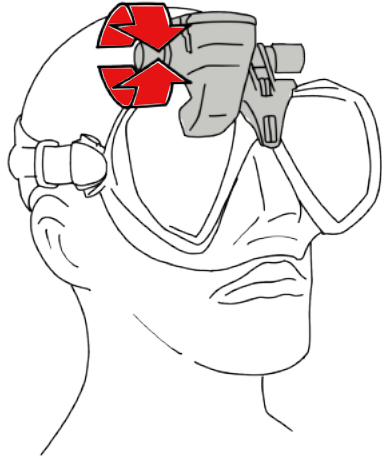
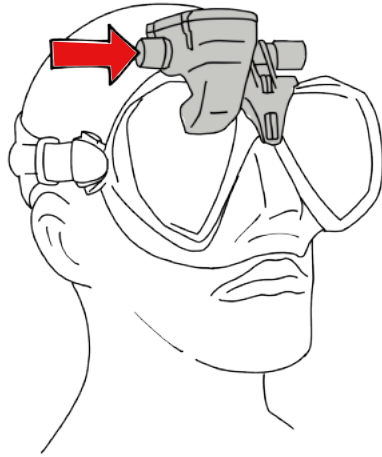

1.10 Basic settings

The initial activation of your HUD requires some basic set-up (selecting language, setting time and date, setting units, etc.).

Starting from the beginning, press-and-release the push-wheel to turn on the HUD. After initialization, the HUD will open on the Surface screen.

From the Surface screen, a press-and-release of the push-wheel takes you to the Main menu.



From the Main menu, rotate the push-wheel to toggle down to Settings, then press-and-release.



From the Settings menu, rotate the push-wheel to toggle down to System, then press-and-release.

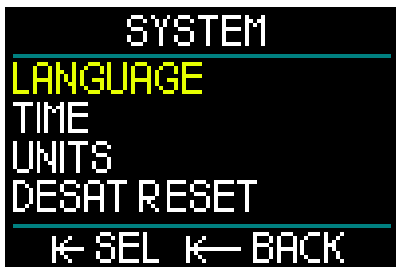

Language

In the System menu the first basic setting is Language. Press-and-release the push-wheel to enter the menu.



The HUD supports a number of different languages. (Go to www.scubapro.com to download more languages.)

By rotating the push-wheel in the Language menu you can toggle through your language choices. Confirm your selection with a press-and-release of the push-wheel which will also return you to the System menu.

Time & Date

From the System menu, rotate the push-wheel to toggle down to Time. Push-and-release.

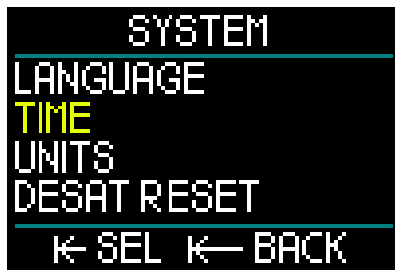

To set both Time and Date, select Set Time and push-and-release.

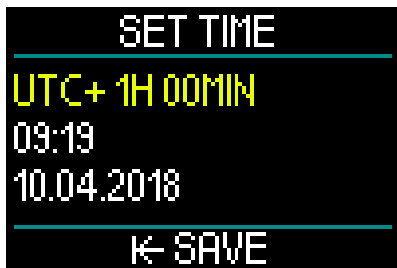
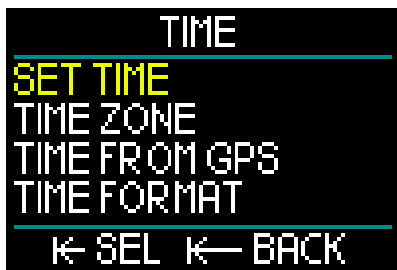

The first setting is Universal Time Coordinated (UTC), also known as Greenwich Mean Time or Zulu Time. This is the primary time standard used worldwide to regulate clocks and time. The HUD provides UTC offset settings that correspond to your location's time zone. These offsets range from -12 hours to +14 hours in 15-minute increments. This enables you to have the UTC offset for your time zone along with the local time.

To set the UTC offset for your location's time zone, rotate the push-wheel up or down, then press-and-release the push-wheel to save your selection. This also advances you to the Hour setting.

Rotate the push-wheel to select time in either 24-hour or AM/PM format. Press-and-release to set and advance to Minutes. Use the same process for Minutes (rotate the push-wheel to select, press-and-release to set) then Year, Month and Day. A press-and-release to set the Day will also return you to the Time menu.

Time Zone



Next, rotate the push-wheel to toggle to Time Zone. Press-and-release.



This menu screen allows you to easily change to local time when traveling to other time zones. Instead of changing the actual time itself, in this menu you can add or subtract a number of hours from the currently displayed time to arrive at the correct time at your new destination.

If you already set the UTC offset for your location in the previous Set Time screen, your Time Zone setting will already be set. If it's not, rotate the push-wheel to set the UTC offset for your location's time zone, then press-and-release to save the setting. If the UTC offset for your time zone has already been set, simply press-and-release the push-wheel and you will return to the Time menu.

Time from GPS

With Time from GPS selected, a push-and-release of the push-wheel will give you an at-a-glance status of your GPS reception, with time and date data coming from the GPS satellites.



If “OK” appears on the screen you have GPS signal reception; if no reception is available, the following symbol is displayed.



For more information on the HUD's GPS function, refer to chapter: GPS.

NOTE: the GPS satellite transfers date and time as UTC. If time shifts are necessary due to region or summer/winter time, then these must be set separately.

Time format

The final setting in the Time menu is Time Format, where you can select how you want to see time-of-day – as well as the current date – presented on the screen. Press-and-release to enter the Time Format menu.



First up is Time Format. Press-and-release.



Here you have a choice of 12-hour or 24-hour time. Rotate the push-wheel to make your selection, then press-and-release.

This will return you to the previous Time Format menu screen.



In the Time Format menu, rotate the push-wheel to toggle to Date Format – press-and-release.



The HUD gives you a choice of 3 date formats. Rotate the push-wheel to select your preference, then press-and-release to save your selection and return to the Time Format menu screen.

From the Time menu screen, a press-and-hold of the push-wheel takes you back to the System menu screen.

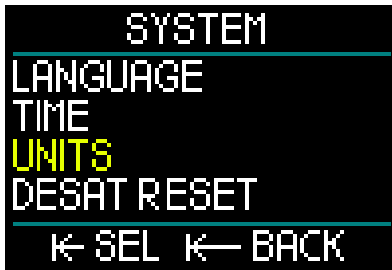

Setting Units

In the System menu, next on the basic settings list is Units. Press-and-release the push-wheel to enter the Units menu.

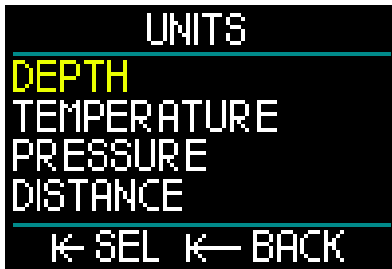

The first setting in the Units menu is Depth. Press-and-release the push-wheel.



In the Depth menu, rotate the push-wheel to select either Meters or Feet. A press-and-release saves your selection and returns you to the Units menu.

From the Units menu, rotate the push-wheel to Temperature. Press-and-release.



In the Temperature menu, rotate the push-wheel to select either Celcius or Fahrenheit. A press-and-release saves your selection and returns you to the Units menu.

From the Units menu, rotate the push-wheel to Pressure. Press-and-release.

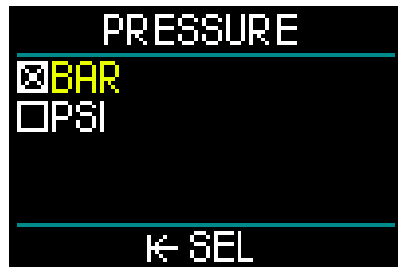

In the Pressure menu, rotate the push-wheel to select either Bar or PSI. A press-and-release saves your selection and returns you to the Units menu.

From the Units menu, rotate the push-wheel to Distance. Press-and-release.

These are the Unit settings you need for the GPS orientation.



In the Distance menu you have a choice of 4 selections for measuring horizontal distance. Rotate the push-wheel to make your selection. A press-and-release saves

your selection and returns you to the Units menu.

From the Units menu, a press-and-hold returns you to the System menu.

Another press-and-hold returns you to the Settings menu.

One more press-and-hold returns you to the Surface screen.

(1.025 kg/l salt) as a constant. Since salt water is denser than fresh water, a depth of 10m/33ft in salt water corresponds approximately to a depth of 10.3m/34ft in fresh water. Since the difference is minimal, and since over 95% of the world's water is salt water, the HUD always shows depth in salt water.

 **NOTE:** The HUD doesn't have a setting for salt water or fresh water. That's because it constantly measures pressure and converts it to a depth value by using ocean water density

The HUD's push-wheel rotation, press-and-release and press-and-hold functions while at the surface and during diving are summarized in the following table.

	PRESS	PRESS AND HOLD	TURN PUSH-WHEEL
SURFACE	Main menu	Shut down	Switch to GPS screen when activated
SCUBA	Main menu (limited selection)	Gas change to recommended gas	Change dive screen
APNEA	Main menu (limited selection)	Finish session when depth < 0.1m	Profile when session is ongoing & while at the surface
CCR	Main menu (limited selection)	Setpoint change when required	Change dive screen
NAVY	Bottom Timer Start / reset Legtime	Switch to different displays	Navigation screen (switch from compass to GPS waypoints)

1.11 No-fly time

No-fly time is the time during which an exposure to the reduced pressure (equal to ascending to higher altitudes) inside the cabin of an airplane could cause decompression sickness, as calculated by the decompression model in the computer. The red no-fly countdown timer is shown until the restriction is completed.

To learn more about altitude warnings and altitude diving, see chapter: Altitude diving.



⚠ WARNING

Flying while the HUD displays the NO FLY countdown timer can result in serious injury or death.

1.12 SOS

If you surface and then stay above a depth of 0.8m/3ft for more than 3 minutes without having observed a prescribed decompression stop during your just-completed dive, the HUD will switch into SOS mode. Once in SOS mode the HUD will lock up and will be inoperable as a decompression dive computer for 48 hours. If it is used for diving within 48 hours of an SOS lock, it will automatically switch to Gauge mode and provide no decompression information.

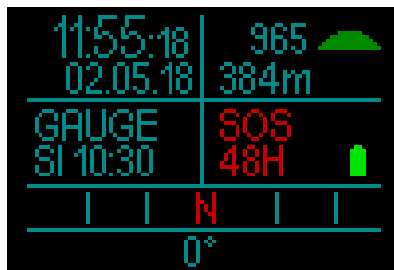

The display shows the SOS mode message.

Instead of the no-fly time, the 48-hour countdown is shown.

⚠ WARNING

- Violating a mandatory decompression obligation may result in serious injury or death.
- Serious injury or death may result if a diver does not seek immediate treatment should any signs or symptoms of decompression sickness occur after a dive.
- Do not dive to treat symptoms of decompression sickness.
- Do not dive when the computer is in SOS mode.
- Going to altitude or flying while the HUD displays the SOS mode can result in serious injury or death.

📖 *NOTE: If the battery becomes fully discharged while at depth in spite of using the Power Save mode, the HUD will be locked into Gauge mode for 48 hours, independent of the remaining desaturation time. After the lock expires the HUD remains in Gauge mode.*

1.13 Mounting and pairing the high pressure transmitter

The HUD can receive tank pressure information from multiple Smart series high pressure transmitters. Each transmitter needs to be mounted on a high pressure port of a first stage regulator.

To mount the transmitter, first remove the high pressure port plug from the first stage regulator, then screw the transmitter in place.

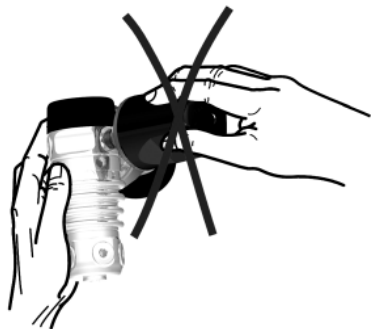
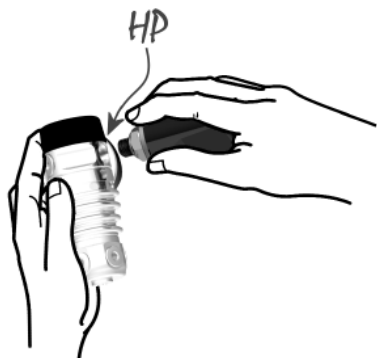

NOTE: Use an appropriate wrench to tighten the transmitter. Take care to not overtighten.



The Smart transmitter communicates with the HUD via radio frequency. For optimal transmitting performance, we recommend positioning the transmitter as described in the following picture.



In order for the HUD to display the pressure signal from a Smart transmitter, a coded and interference-free line of communication must first be established. This step needs to be performed only once for each transmitter.

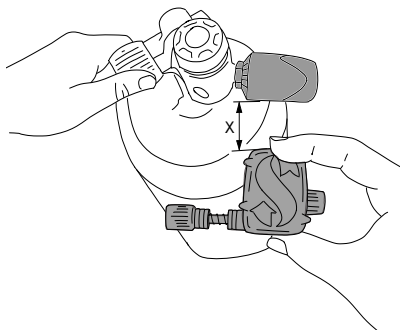

To pair your HUD with the transmitter, proceed as follows:

1. Mount the first stage regulator with Smart transmitter on a full tank.
2. Turn on the HUD. From the Surface screen press-and-release the push-wheel to get to the Main menu.

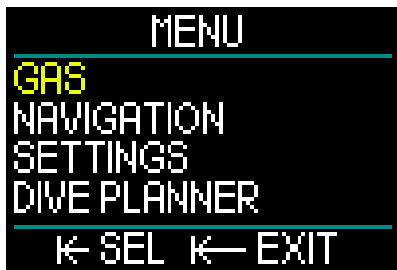

3. From the Main menu select Gas and press-and-release.

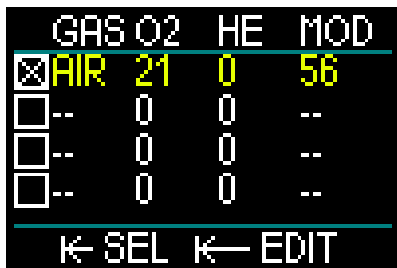

4. From the Gas menu select the gas you want to pair to. A press-and-release will save your selection (indicated by an "X" in the box next to the selected gas) and return you to the Main menu screen.

5. Rotate the push-wheel to toggle down to Settings. Press-and-release.

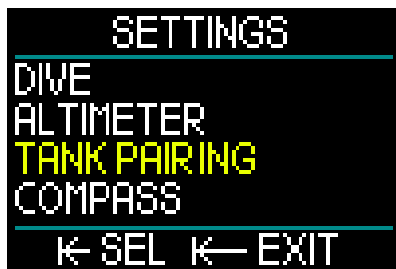

6. From the Settings menu rotate the push-wheel to toggle down to Tank Pairing. Press-and-release.



7. The gas you selected in Step 4 will be highlighted. Press-and-release the push-wheel. This will start the pairing process as a countdown timer starts.



8. As the timer counts down, open the tank valve. Upon pressurization, the Smart transmitter will send a pairing sequence to the HUD.



9. Wait until the transmitter and HUD are connected. Once a successful pairing is made the screen will display "OK" and revert to the Tank Pairing screen.

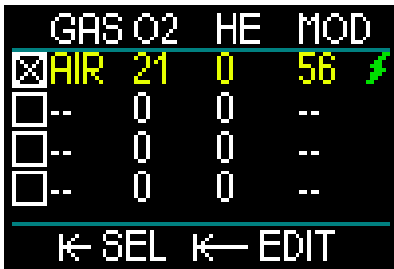

At the same time, on the Gas menu screen a green lightning symbol now shows that the transmitter is paired to that gas.

To pair another transmitter start at Step 3 and repeat the process.

NOTE: You can extend the timeout period by giving the wheel a short press.

If at any time you decide to abort the pairing procedure, press-and-hold the push-wheel and the HUD will stop the pairing process and the settings will remain.

Also, the pairing of the selected gas will be deleted if the timeout countdown goes to 0.

NOTE: The transmitter must have been unpressurized for at least 40 seconds prior to attempting a pairing operation; if not, it will not transmit the pairing sequence.

Also, a transmitter can only be paired to one tank designation. If you pair the same transmitter to a second tank designation, the first pairing will be erased. However, you can pair more than one HUD to the same transmitter.

Finally, when performing the pairing operation, make sure that only one transmitter is activated within 2.5m/8ft so that you will pair to the right tank.

After a successful pairing, on the Surface screen the tank pressure will appear in either BAR or PSI in the lower left hand corner, accompanied by a pressure bar running up the left side of the screen.

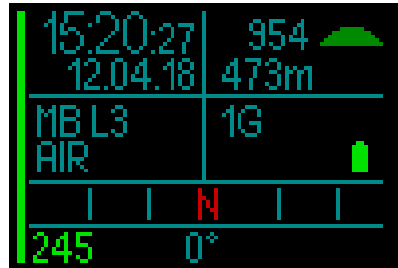

If a NA appears in the lower left hand corner instead of a pressure value, that means the HUD is paired but no signal is available.

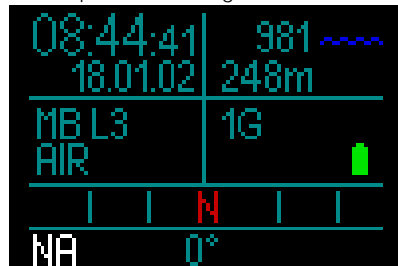

NOTE: The Smart transmitter has a range of approximately 1.5m/5ft. To maximize the life of the battery, the transmitter operates at a low update rate when there is no pressure change for more than 70 seconds. The transmitter also turns itself off when the pressure is 8bar/200psi or less. If a transmitter battery is weak, the HUD will alert you with a screen message displaying.

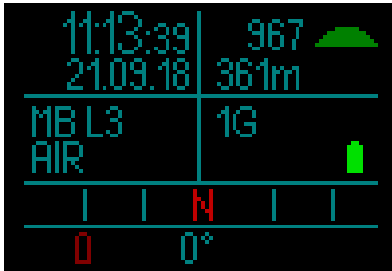

See chapter: **Replacing the battery in transmitter** for information on how to replace the transmitter battery.

Wireless tank pressure information, under certain circumstances—such as inappropriate positioning of the transmitter or interference from strong RF sources, can be momentarily interrupted. Strobes used in underwater photography, for example, are known to momentarily affect the communication between the HUD and the wireless transmitter.

NOTE: If the HUD receives no signal from the transmitter for 30 seconds, the last received measurement stays on the display and the RBT calculation is based on this value. After another 30 seconds without a signal, the display changes to “NA” and the RBT is deleted on the display. If the signal is re-established, the measurement and RBT will once again be displayed.

⚠ WARNING

In the event of a “no signal available” situation, all tank pressure-related information on the HUD ceases to be valid. In such a case, you must use a backup instrument for pressure monitoring and seek a safe ascent to the surface. Running out of gas under water is dangerous and may lead to severe injury or death by drowning.

1.14 Turning off the HUD

The HUD turns off automatically after 5 minutes without active use. When in the Surface screen, you can turn the HUD off manually with a press-and-hold of the push-wheel.

2. HUD SETTINGS AND MENUS

Navigating through the HUD menu system is easily accomplished by rotating the push-wheel and using a combination of press-and-release and press-and-hold actions.

By rotating the push-wheel you can select a category from a menu list. A push-and-release of the push-wheel lets you enter your selected category.

For your convenience, at the bottom of each menu and category screen the push-wheel-press functions are indicated, so regardless of where you are in the system, you'll know what type of push-wheel press is required to make a selection, save a selection, go back a screen, or exit the menu.

The following chapters are sorted by the menu structure in the HUD.

From the Surface screen (the screen the HUD opens onto after being turned on) a press-and-release of the push-wheel takes you to the Main menu.

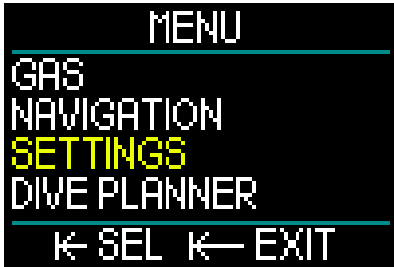

The Main menu offers the following categories, pages and settings:

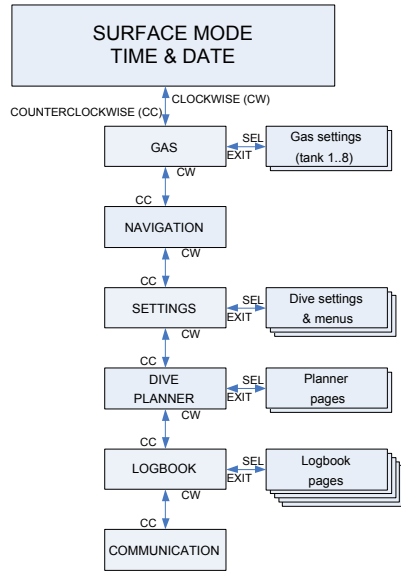

By surfing these menus you can quickly become familiar with them. Following are short descriptions for each selection.

2.1 Gas

From the Main menu, by selecting Gas and pressing-and-releasing the push-wheel you enter the Gas Settings screen.

	GAS	O2	HE	MOD
<input checked="" type="checkbox"/>	AIR	21	0	56
<input type="checkbox"/>	--	0	0	--
<input type="checkbox"/>	--	0	0	--
<input type="checkbox"/>	--	0	0	--

← SEL ← EDIT

The HUD lets you program or change up to 8 gases. When you set your oxygen and helium levels, the Maximum Operating Depth (MOD) limit will automatically be shown for the values you selected. To learn more about diving with Nitrox and MOD, see chapter: **Diving with nitrox**.

2.1.1 Recreational (factory setting)

For normal one-tank diving you can select a gas mix from 21% oxygen (air) up to 100% oxygen. The ppO₂ max value is required for the MOD limit you intend to use for this gas. The factory setting is 1.40bar.

⚠ WARNING

The MOD limit defines the warning depth based on oxygen toxicity. However, depth narcosis can affect a diver's skills much earlier, jeopardizing his or her ability to dive safely at that depth.

	GAS	O2	HE	MOD
<input checked="" type="checkbox"/>	AIR	21	0	56
<input type="checkbox"/>	NX	50	0	18
<input type="checkbox"/>	O2	100	0	6
<input type="checkbox"/>	--	0	0	--

← SEL ← EDIT

Gas 1 (the first line) is always the default gas that you would use at the start of the dive. It can be set from 18% oxygen to 100% oxygen. The helium fraction you can select from 0% to 82% He.

Gas 2 through 8 values can be adjusted the same way as Gas 1. The oxygen mix can be set from 8% oxygen up to 100% oxygen. The helium fraction you can select from 0% to 92% He.

The final gas, located on the last line, can be programmed like the other gases, PLUS it can be edited during a dive. It appears in green for easy readability, so you can set it in an emergency situation – like when it suddenly becomes necessary to breathe a gas off your dive buddy's system.

⚠ WARNING

If you have the 8th gas preset before the dive, and then you delete it during the dive, it is possible that your total ascent time will increase more than you might have expected, in which case an out-of-air situation can potentially occur during that dive's ascent.

⚠ WARNING

Gas switching to unknown mixtures while diving is extremely dangerous and can lead to convulsions and death by drowning. Never switch to a gas under water that you have not analyzed yourself.

	GAS	O2	HE	MOD
<input type="checkbox"/>	--	0	0	--
<input type="checkbox"/>	--	0	0	--
<input type="checkbox"/>	--	0	0	--
<input type="checkbox"/>	NX	30	0	36

← SEL ← EDIT

 **NOTE:** To ensure an adequate supply of oxygen to the body, the gas used at the beginning of the dive must contain enough oxygen to meet your body's requirements (you can use a travel mix or one of the decompression gases).

WARNING

Engaging in heavy work while at the surface or at shallow depths while breathing less than a 21% oxygen (hypoxic mix) fraction may cause a loss of consciousness and lead to drowning.

A ppO_2 max value between 1.3bar and 1.6bar must be set for the MOD limit you intend to use for all gases. The factory setting is 1.40bar.

 **NOTE:** To adjust the ppO_2 max, you would proceed from the Main menu to Settings to Dive to Max ppo_2 and make your adjustment. For more information on setting the ppO_2 , see chapter: ppO_2 max.

2.2 Navigation

From the Main menu, by selecting Navigation and pressing-and-releasing the push-wheel you enter the Navigation menu.



In the Navigation menu you can set your preferred compass directions and GPS waypoints. This menu is accessible in all dive modes.

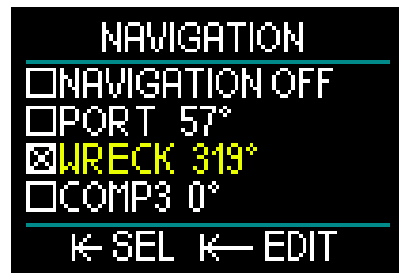

If you don't use a compass during diving, you also have the choice of setting the navigation function to Off. However, if you change your mind you can always activate your compass menu during a dive.

2.2.1 Compass

In the Navigation menu 3 different compass directions, or bearings, can be selected and stored. A bearing can be changed at any time during a dive or while on the surface, and you can always switch between different bearings.

To load or edit a compass bearing, rotate the push-wheel to COMP1 and push-and-hold to enter.

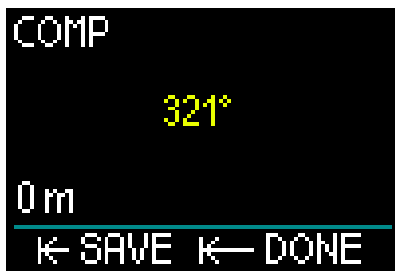

Point the HUD in the direction you want to travel and press-and-release the push-wheel to lock in the bearing.

The HUD now lets you create a name for this compass bearing. Note that in the upper left hand corner of the screen the first letter of the default name is highlighted in yellow. By rotating the push-wheel you can select the first letter of your bearing's new name, and confirm with a press-and-release of the push-wheel.

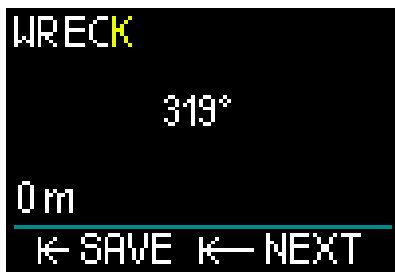

Repeat this process with each highlighted letter until you finalize the compass bearing's new name, then press-and-hold the push-wheel to save. This action also moves you to the depth setting.

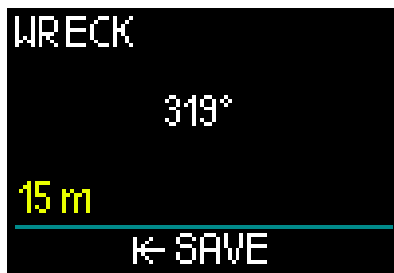

Being able to select a depth in concert with the compass bearing is a handy function that can aid, for example, in finding a sunken wreck. Select the depth you want to store by rotating the push-wheel, then save your selection with a press-and-release. This will also return you to the Navigation menu.

NOTE: The HUD's compass is intended for use during diving, while its GPS is for surface use only.

2.2.2 GPS

Once you reach the surface you are able to use the HUD's GPS function.

Similar to storing compass bearings, you have the ability to add up to 32 GPS waypoints.

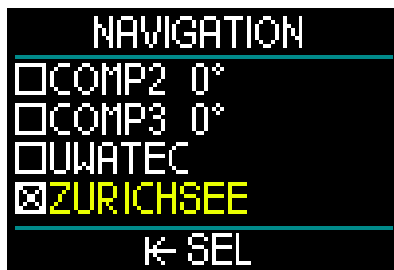

To add waypoints to the Navigation menu see chapter: Adding GPS waypoints

REMINDER: The HUD's GPS uses physical properties (longitude and latitude) on the surface for navigation, and so is not functional at depth. Therefore, always use the HUD's compass for navigating while diving, and switch to GPS navigation only after returning to the surface.

2.3 Settings

From the Main menu, by selecting Settings and pressing-and-releasing the push-wheel you enter the general Settings screen.

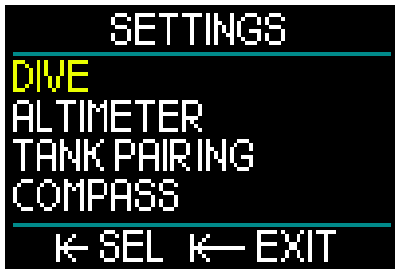

The Settings menu offers the following categories, pages and settings. By rotating the push-wheel you can toggle to each selection, and then enter with a press-and-release of the push-wheel. Let's look at them one at a time.

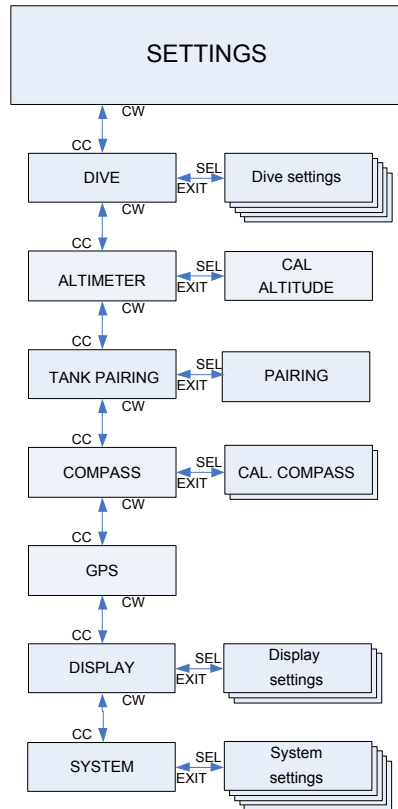

2.3.1 Dive settings

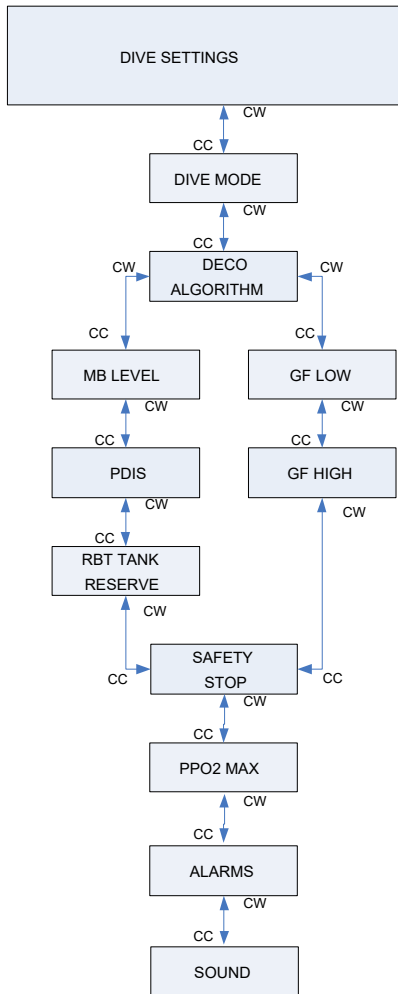

2.3.1.1 Dive mode

From the Settings menu, by selecting Dive and pressing-and-releasing the push-wheel you enter the Dive Settings screen.

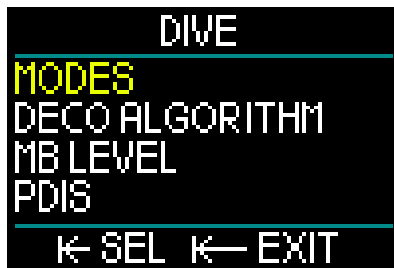

From the Dive Settings menu, by selecting Modes and pressing-and-releasing the push-wheel you enter the Modes screen.



Your HUD allows you to choose between SCUBA, Gauge, Apnea and CCR modes.

Rotating the push-wheel toggles you to your mode selection. A press-and-release of the push-wheel saves your selection and returns you to the Dive Settings screen.

- The SCUBA mode shows recreational No Stop Time, RBT and calculates required decompression.
- The Gauge mode does not calculate decompression. It is used as a bottom timer. At the end of a Gauge mode dive a 48-hour locking interval occurs. There are no additional setting menus in Gauge mode. For more information on diving in Gauge mode see chapter: Gauge mode.
- The Apnea mode also does not calculate decompression. It is used for freediving. At the end of the dive the 48-hour locking interval occurs as well. There are no additional setting menus

in Apnea mode. For more information on diving in Apnea mode see chapter: Apnea mode.

- The CCR mode is used for close-circuit rebreather diving. See chapter: CCR mode for information about the additional settings.

NOTE: Since Gauge and Apnea modes do not track tissue saturation, a 48-hour locking interval occurs between the time the last dive is made in Gauge or Apnea mode and a change to SCUBA or CCR mode is possible. Conversely, the HUD, once it has been dived in SCUBA or CCR mode, cannot be changed to Gauge or Apnea mode until the no-fly time has elapsed.

If you decide to change modes before the 48-hour interval ends, you will have to go to the desaturation reset menu and perform a manual desaturation reset. For more information on the manual desaturation reset function, go to chapter: Desat reset

2.3.1.2 Deco algorithm

Prof. Albert A. Bühlmann, a name most divers know well, wrote the algorithms that continue to form the basis of decompression calculations today.

Bühlmann created the Bühlmann ZH-L16C. For over 20 years, UWATEC has been developing this algorithm and constantly adapting it to be state of the art. The result is the ZH-L16 ADT MB PMG algorithm, which is the primary – or default – algorithm used in the HUD.

However, some divers prefer to return to the roots of Prof. Bühlmann’s thinking on calculating decompression, known as the Gradient Factors (GF) approach, which provides additional options for increased conservatism. Gradient Factors can be set from no conservatism at all (100/100) to any value in between. The ZH-L16C basic diving algorithm is used as a basis for this Gradient Factor approach.

The technical diving community, in particular, finds that the Gradient Factors approach best suits their diving needs. So in an effort to address the preferences of all

divers, the HUD offers both the traditional GF algorithm and the modern ZH-L16 ADT MB PMG algorithm.

NOTE: To learn more about Gradient Factors see the web articles “Clearing Up the Confusion” and “Understanding M-Values,” both by Erik Baker.

From the Dive Settings menu, by selecting Deco Algorithm and pressing-and-releasing the push-wheel you enter the algorithm menu.



Here you can select either algorithm.

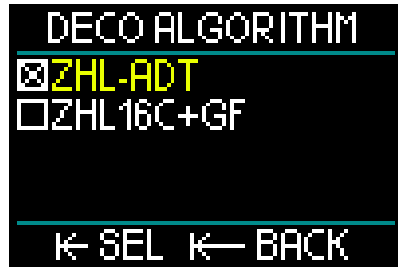

- ZHL-ADT is the Bühlmann ZH-L16 ADT MB PMG (the default setting).
- ZHL16C+GF is the Bühlmann ZH-L16C with the potential of additional conservatism using Gradient Factors.

As ZHL-ADT is the default algorithm, switching to the GF algorithm requires that you rotate the push-wheel to toggle to that algorithm selection.



A press-and-release of the push-wheel takes you to a separate confirmation display.



Another press-and-release confirms that the algorithm has been changed and returns you to the Dive Settings menu.

NOTE: Any current tissue saturation data has to be deleted before you switch the algorithm. Use the function desat reset.

If you selected the ZHL16C+GF algorithm you'll notice that the Dive Settings menu has changed to enable you to set the two Gradient Factors (in place of MB level, PDIS and tank reserve).



- GF Low is the numerical setting that represents the percentage of

the M-value (maximum value) that determines your first stop during a diving ascent. The GF Low should not be exceeded at any point during the stops.

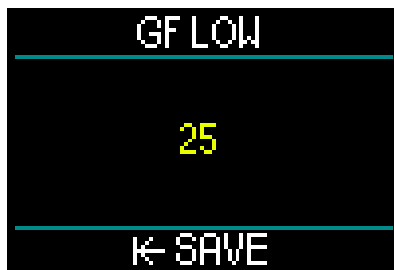

(Example of a GF Low setting)



- GF High is the numerical setting that represents the percentage of the M-value that should not be exceeded at any point prior to surfacing.

NOTE: The GF High defines the length of the last stops, with 100% being the maximum (no conservatism at all).



(Example of a GF High setting)

⚠ WARNING

Only divers with a thorough understanding of Gradient Factors and their M-values should attempt to set GF Low and GF High percentages or use the ZHL16C+GF algorithm.

2.3.1.3 MB level

From the Dive Settings menu, by selecting MB Level and pressing-and-releasing the push-wheel you enter the Microbubble Level selection screen.



Here you may select the preferred Microbubble (MB) level from 0 to 5 that you want to follow during your dives. Level 0 is the least conservative. Level 5 is the most conservative.

Rotating the push-wheel toggles you to your selection. A press-and-release of the push-wheel saves your selection and returns you to the Dive Setting menu screen.

Activating the MB level function is only possible when you're diving with the ZHL-ADT algorithm.

👉 *NOTE: For more about diving with Microbubble levels, see chapter: Diving with MB levels.*

2.3.1.4 PDIS



From the Dive Settings menu, by selecting PDIS and pressing-and-releasing the push-wheel you enter the Profile Dependent Intermediate Stops activation screen.



The HUD's Profile Dependent Intermediate Stops feature calculates an intermediate stop based on how much nitrogen uptake your body has endured, taking into account your current dive, previous dives, and breathing mixes. Enabling the PDIS feature is only possible when you're diving with the ZHL-ADT algorithm. A press-of the push-wheel saves your selection and returns you to the Dive Settings menu screen.

See chapter: **PDIS (Profile Dependent Intermediate Stop)** to learn more about this feature.

2.3.1.5 RBT tank reserve

From the Dive Settings menu, by selecting RBT Tank Reserve and pressing-and-releasing the push-wheel you enter the RBT Tank Reserve setting screen.



RBT (remaining bottom time) is the time you can spend at the current depth and still have enough gas supply to make a safe ascent and reach the surface with the tank reserve.

The RBT calculation is based on your current breathing rate, it accounts for any existing and upcoming decompression obligation. It also assumes an ascent at the ideal ascent rate (defined in chapter: Ascent rate).

Since RBT is based on your breathing pattern, the RBT calculation cannot be extended to more than one tank during a dive. Therefore, RBT cannot be shown if multiple gases are set in the gas table.

You can set your RBT tank reserve pressure by rotating the push-wheel. A press-and-release of the push-wheel saves your setting and returns you to the Dive Settings menu screen.

 **NOTE:** Setting a higher value for your tank reserve is more conservative but limits your diving time. Setting a lower value gives you more diving time but increases the risk of running out of gas supply before reaching the surface.

The RBT function can only be activated when you're diving with the ZHL-ADT algorithm

2.3.1.6 Safety stop



From the Dive Settings menu, by selecting Safety Stop and pressing-and-releasing the push-wheel you enter the screen for enabling or disabling the safety stop timer.

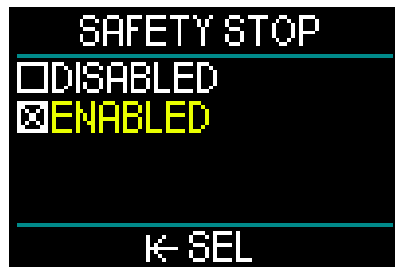

A press-and-release saves your selection and returns you to the Dive Setting menu screen. (See chapter: Safety stop timer to learn how this feature is used while diving.)

2.3.1.7 ppO₂ max



From the Dive Settings menu, by selecting ppO₂max and pressing-and-releasing the push-wheel you enter the screen for adjusting your ppO₂ max setting.

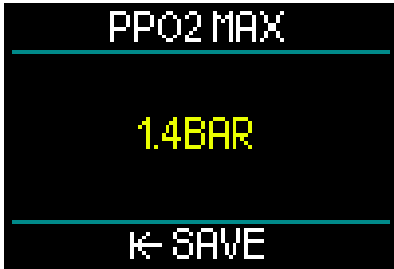

The ppO_2 max setting defines the limit for oxygen partial pressure. It is the same for all gases. The HUD offers ppO_2 max settings from 1.3bar to 1.6bar (1.4bar is the factory setting).

2.3.1.8 Alarms

From the Dive Settings menu, by selecting Alarms and pressing-and-releasing the push-wheel you enter the screen for setting alarms.



Alarms represent situations that require a diver's attention. It is up to you to decide which warning alarms you would like to have active.

The HUD Alarms menu lets you set alarms for maximum depth and maximum dive time.

When an alarm is activated a buzzer will beep and the critical value on the screen changes color to red.

Maximum dive depth alarm

By rotating the push-wheel the maximum depth warning value can be selected from 1-120m/3-394ft in 1m/3ft increments. To save the set value and activate the alarm press-and-release the push-wheel. To disable the maximum depth warning alarm, press-and-hold the push-wheel. Either

action will return you to the Dive Settings menu screen.



NOTE: When the alarm is on and set the top row will read MAX DEPTH 30M. When the alarm is turned off the top row will read simply MAX DEPTH.

Maximum dive time alarm

By rotating the push-wheel the maximum time warning value can be selected from 1 to 995 minutes in 1-minute increments. To save the set value and activate the alarm press-and-release the push-wheel. To disable the maximum time warning alarm, press-and-hold the push-wheel. Either action will return you to the Dive Settings menu screen.



NOTE: When the alarm is on and set the top row will read MAX TIME 60 MIN. When the alarm is turned off the top row will read simply MAX TIME.



From the Alarms menu screen, if the values are shown, that indicates the alarms are activated.

2.3.1.9 Sound



From the Dive Settings menu, by selecting Sound and pressing-and-releasing the push-wheel you enter the screen for enabling or disabling sounds.



When Sound/Enabled is selected, then alarms and warnings are active and audible. When Sound/Disabled is selected, then the HUD switches into an all-silent mode.

In order to go all-silent, the safety code (313) must be input. Once this occurs, no alarms or warning will emit an audible signal.

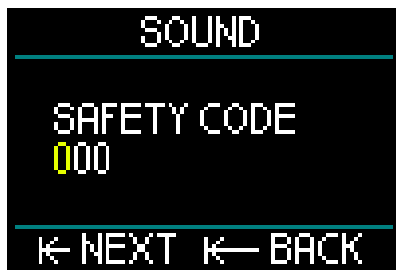

▲ WARNING

The sound OFF selection will disable all audible dive mode alarms and warnings. This is potentially dangerous.

2.3.2 Altimeter

The next category in the Setting menu is Altimeter. Here you can check your current elevation.

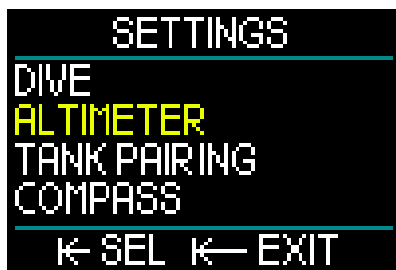

A press-and-release of the push-wheel and you enter the Altitude menu.



In the Altitude menu, the current altitude is calculated from the barometric pressure. The altitude can be adjusted when the current elevation is known. (Adjusting the altitude elevation will have no effect on your diving.)

NOTE: Barometric pressure is highly variable, changing with weather and elevation. The altitude displayed on your HUD is determined based on the current barometric pressure and is therefore a relative value.

2.3.3 Tank pairing

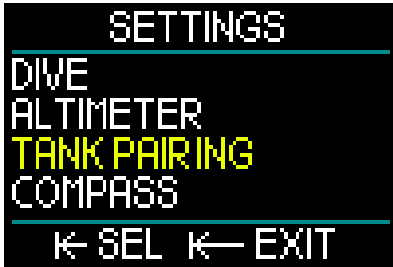

Next in Settings is Tank Pairing. A press-and-release of the push-wheel will put you into the menu where you can create the wireless connection between your Smart transmitter and your HUD.

For step-by-step details on tank pairing see chapter: **Mounting and pairing the high pressure transmitter**

2.3.4 Compass

The HUD comes with an easy-to-use tilt compensating digital compass that is displayed along the bottom of Surface and Dive screens.

Before using your HUD you'll need to calibrate the compass and, to maximize accuracy, set the declination for your location.

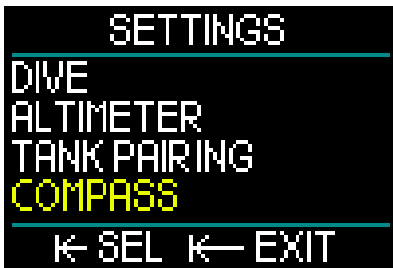

To do this, scroll down to Compass on the Settings menu and press-and-release the push-wheel.

Compass calibration

The first selection on the Compass menu screen is "Cal Compass," or calibration. A press-and-release of the push-wheel starts the calibration process.

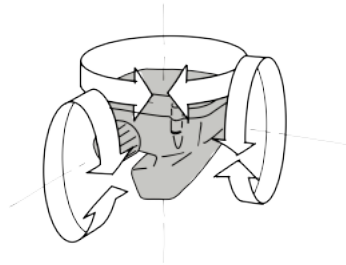

Slowly turn the HUD in random directions and around different center lines. The more different points that can be recorded, the better the calibration.

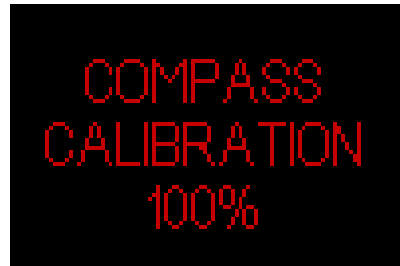

The percentage (%) displayed during calibration shows the progress of the process.

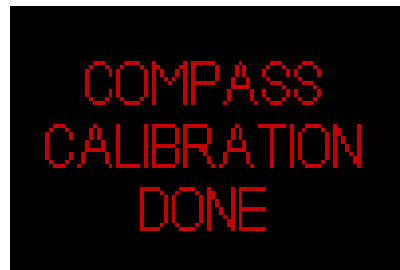

NOTE: The HUD's compass does not normally need recalibration. However, if you notice a significant permanent offset in compass direction, please perform the calibration procedure.

 **NOTE:** When calibrating or using the HUD compass, make sure you're not too close to items that can create magnetic field interference (radios, stereo speakers, flashlights, metal tools, etc.).

Declination

A compass points to the magnetic North Pole of the earth. The variation caused by your geographic position relative to the magnetic North Pole is corrected with a declination setting.

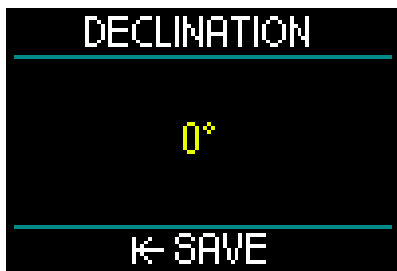

Your magnetic declination setting depends on your location on the earth. You can find your area's declination simply by doing a Google search. HUD lets you select a correction value from -90 degrees (West) to +90 degrees (East) in 1-degree increments. Once set, it won't have to be changed unless you travel.

2.3.5 GPS

The HUD's innovative onboard surface Global Positioning System (GPS) lets you easily find your way back to your starting point or to fixed locations in unfamiliar diving locales or when dealing with low-visibility conditions. Utilizing GPS and QZSS satellite tracking systems enables the HUD's surface GPS to be a highly accurate navigation aid worldwide.

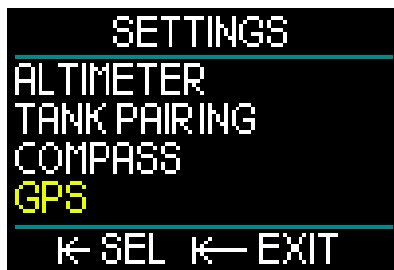

From the Settings menu, scroll down to GPS and press-and-release the push-wheel to enter the GPS menu's activation screen.

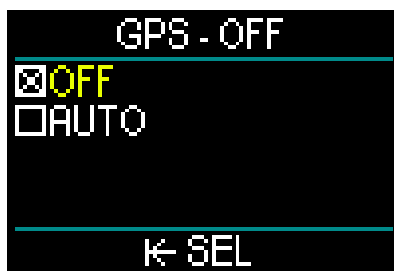

The GPS menu screen offers 2 settings: OFF and AUTO.

When set to OFF the HUD's GPS receiver is disabled. This setting is useful during those times when surface GPS functions are not required, or when you want to conserve battery power to extend the time between charges. In this mode the Settings screen shows the GPS as OFF.

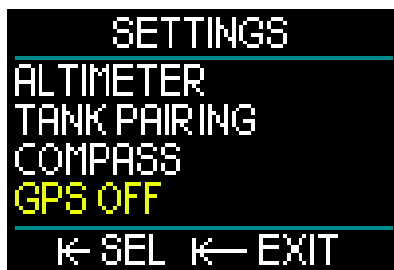

When AUTO is selected the GPS Sensor is activated and starts to work whenever the HUD is switched on and is on the surface. This allows you to find your home target after your dive as you're kicking back on the surface.



When in GPS AUTO mode, from the Surface screen, by rotating the push-wheel you can get the current time, date, as well as your GPS coordinates. Also displayed is the True Heading (TH) to the current set waypoint, and the Total Distance (TD) to that waypoint.



NOTE: after a period of time without a GPS signal it takes about 3 minutes for the GPS function to reacquire date, time and location data.

REMINDER: Having the GPS sensor activated decreases the battery charging level.

NOTE: To import waypoints to the Navigation menu, see chapter Adding GPS waypoints

NOTE: to use the GPS during diving at the surface see chapter: **Navigation**.

2.3.6 Display

The HUD lets you regulate the brightness of the OLED screen and choose between color schemes for viewing your dive data.

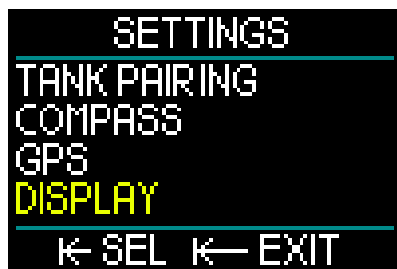

From the Settings menu, scroll down to Display and press-and-release the push-wheel.

2.3.6.1 Brightness



From the Display menu, select OLED Brightness and press-and-release the push-wheel.



By rotating the push-wheel you can select the screen brightness setting from 0 (dimmiest) to 10 (brightest) to suit your visual preferences.

However, keep in mind that when it comes to power consumption, the display is the

primary factor in determining battery life between charges. In other words, the level of brightness you select will determine how much time you will have before a recharge is required.

 **NOTE:** To extend battery life until your next recharge, reduce the brightness level. This setting can be changed on the surface and also while diving.

2.3.6.2 Color schemes



From the Display menu, scroll down to Color Schemes and press-and-release the push-wheel.

New Color Schemes will be available at www.scubapro.com

2.3.6.3 Power save mode

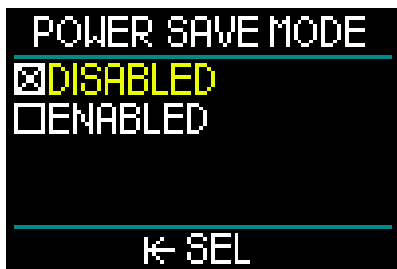

To conserve battery power during a dive you can enable the Power Save mode.

In Power Save mode the display shuts off after 30 seconds at the same depth. You can enable the display with a short press of the push-wheel at any time. This function can be enabled or disabled on the surface as well as during a dive.

2.3.7 System

The System menu is where you can set the basic parameters of your HUD dive computer.

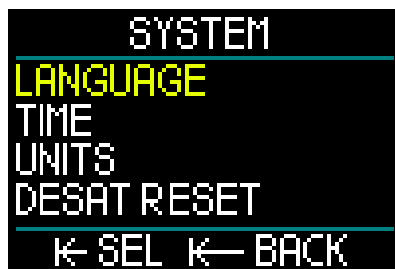

By rotating the push-wheel you can scroll to the following sub-menus. A push-and-release of the push-wheel lets you enter.

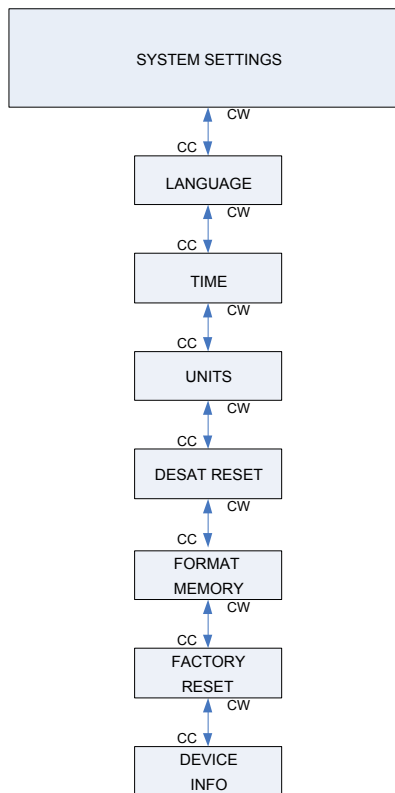

2.3.7.1 Language

For more information on selecting and setting your preferred language, see chapter: 1.10 Basic settings.

2.3.7.2 Time

For more information on setting Time and Date, Time Zone, Time from GPS and Time Format, see chapter: 1.10 Basic settings.

2.3.7.3 Units

For more information on setting metric or imperial units for Depth, Temperature, Pressure and Distance, see chapter: 1.10 Basic settings.

2.3.7.4 Desat reset

The HUD provides a function that allows you to reset your desaturation history.

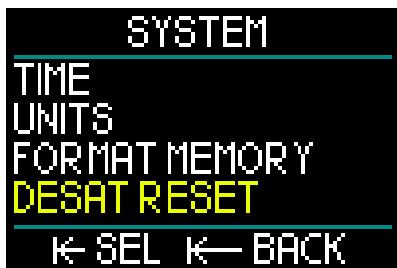

Any tissue saturation information from a recent dive can be reset to zero, allowing the HUD to treat the next dive as a non-repetitive dive. This function is useful when the HUD is going to be loaned to another diver who has not dived in the last 48 hours.

WARNING

Resetting desaturation will affect the calculations of the algorithm, which may lead to serious injury or death. Do not reset desaturation without a valid purpose.

NOTE: Some menu changes are not possible while the HUD is counting down desaturation. If you decide to reset desaturation, the safety code 313 must be used. This procedure prevents unwanted resetting, plus the desaturation reset will be stored to memory; in the next dive log the desaturation reset warning will be shown.

To reset desaturation, press-and-release the push-wheel to enter the reset desaturation menu screen.



Input the first number of the safety code, followed by a press-and-release, repeat for the second number, and then the third.

When the safety code is correctly entered and confirmed with a press-and-release of the push-wheel, the desaturation reset is complete and the following screen will appear.



NOTE: After a desaturation reset the change between Scuba, Gauge, Apnea and CCR modes are possible immediately. However, since the Gauge and Apnea modes are not tracking your tissue nitrogen loading, it is recommended that you maintain the initial intervals between mode changes.

⚠ WARNING

Diving after a desaturation reset is extremely dangerous and is very likely to cause serious injury or death. Do not reset the desaturation unless you have a valid reason for doing so.

NOTE: An automatic low battery switch-off will not reset the desaturation. The HUD stores tissue saturation information in a non-volatile memory. During the time the computer is without power the desaturation calculation is on hold. During recharging, the display will light up and the desaturation calculation will resume (at a more conservative rate) as soon as a sufficient level of charge has been reached. But the desaturation time that occurred during the power loss will be lost. This will be indicated when the no-fly time (47H) appears on the screen in white. If you are sure that the no-fly time is not valid anymore because the period of time that has passed is longer than the no-fly time shown before the power loss, then after recharging the HUD you can reset the desaturation which will zero out the no-fly counter.

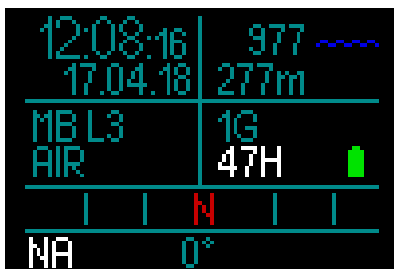

2.3.7.5 Format memory

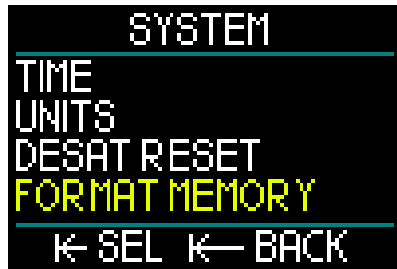

This function allows you to delete the logbook and all compass and GPS waypoints. However, all settings, time and saturation data (if any) remain. Press-and-release the push-wheel to access the Format Memory menu

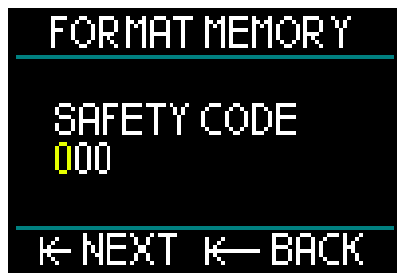

First you need to enter the safety code (313). This requirement prevents unintentionally reverting to logbook.

After inputting the correct safety code the following screen appears.



If the memory formatting is successful, this will be quickly followed by the following screen.



☞ *NOTE: If HUD communication is interrupted during the flash memory write process, or if the HUD's battery power is exhausted while the flash is being used, the memory content may become corrupted. In such an event you can also use this format memory function.*

☞ *NOTE: After completing the Format Memory function, an empty logbook, accessed from the Main menu, will be indicated by the following symbol on the logbook screen.*



WARNING

Do not use the HUD if the flash disk becomes corrupted. The HUD may not operate correctly when flash memory access is not available. False operations may display faulty information. During a dive this may lead to serious injury or death.

☞ *NOTE: To prevent flash disk corruption, 1) use the Safe Remove and Eject Media function, and 2) keep the HUD battery charged to prevent unintended resets.*

2.3.7.6 Factory reset

This menu allows you to revert all settings in all menus of the computer back to the original factory settings. In order to do this, you need to enter the safety code (313).

This prevents unintentionally reverting all settings.

2.3.7.7 Device info

This menu displays the HUD's software version, the hardware version and the device ID number.



2.4 Dive planner

The HUD's dive planner can be accessed from the Main menu.



With the dive planner you can plan your next dive based on your body's nitrogen saturation. It will also help you learn how your HUD is functioning during the dive.

The planner can simulate your dives according to your different depth levels. The simulation runs with an acceleration of 10. So 6 seconds of simulator time correspond to 1 minute of dive time.

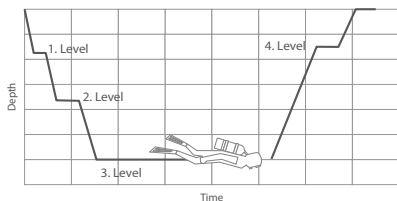

The dive planner makes use of the following information:

1. Your selected algorithm.
2. Your selected gas from the gas table (this can be changed during the simulation).
3. Your selected microbubble level (also adjustable during the simulation).
4. Your saturation status at the time the planner is activated.
5. A constant water temperature of 15°C/59°F.
6. The altitude.
7. A descent speed of 20m (66ft)/min.
8. An ascent speed of 10m (33ft)/min.

NOTE: When the HUD is in Gauge or Apnea mode the dive planner is disabled.

NOTE: if the power cable is connected the dive planner is disabled

NOTE: Any adjustments or changes made during a simulation are automatically deleted at the end of the simulation, with the exception of the OLED screen brightness and any change in the power save mode.

From the Main menu select Dive Planner and press-and-release the push-wheel,



The dive planner opens in the first level. Select NEXT LEVEL, and press-and-release the push-wheel.

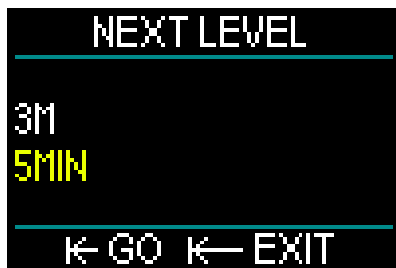

Select your dive depth and the dive time.

- Depth can be selected from 3-120m (increment of 1m).
- Time can be selected from 1-60min (increment of 1 min).

With depth and time selected, press-and-release GO and the simulation begins.

The HUD simulates a 20m/min descent to the entered depth and remains at this depth until the time is finished.

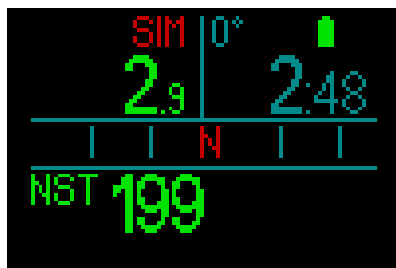

The red SIM at the top of the display shows you that you are in simulation mode.



When you reach the end of your simulation time you can either proceed to the next level of depth and time or stop the simulation.

If the simulation time has not yet expired you don't have the option of going to the next level – you can only stop the dive planner (with a press-and-release of the push-wheel, which returns you to the Main menu).



After a simulation ends, if no action is taken for 1 minute, the dive planner automatically reverts to the Surface screen.

Before 1 minute elapses you can add additional simulation levels by repeating the same procedure. There is no restriction on the number of levels you can program.

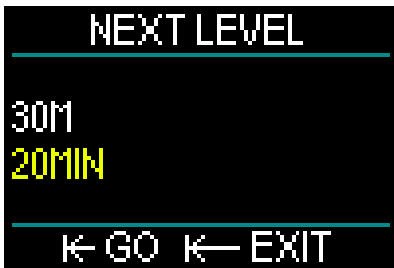

All the information you would see during an actual dive is displayed during the

simulation. You can also use the HUD the same way you would during an actual dive. For example, you can switch gases, change microbubble levels, adjust display settings and toggle through the different screens.

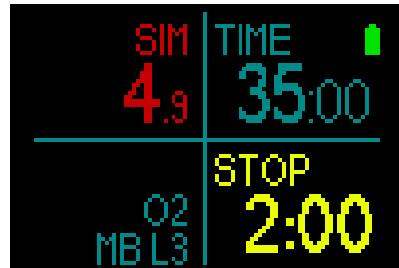
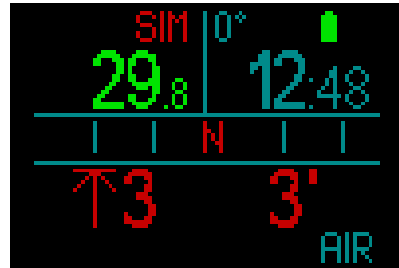

If you plan a dive with remaining saturation in your body and on your HUD, the planner will calculate the dive based on your current status, starting from the moment you activate the planner.

The longer you stay on the surface the more time your body has to desaturate, so make sure to repeat the dive planner directly before your dive to get the most updated values.

2.5 Logbook

The HUD features a 2GB storage capacity and can hold more than 10,000 hours of dive data.



From the Main menu, rotate the push-wheel to toggle down to Logbook, then press-and-release.

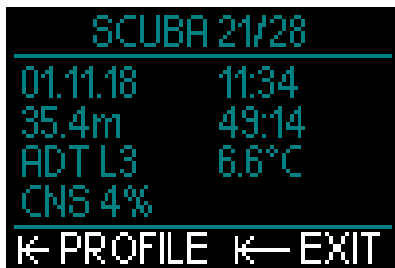

This brings you to the first page of your logbook. For easy reference, each logged dive is numbered, starting with your most recent dive.

The first page shows Date, Time, Depth, Total Dive Time, the Deco Algorithm with either MB Level or the Gradient Factor, and CNS saturation.

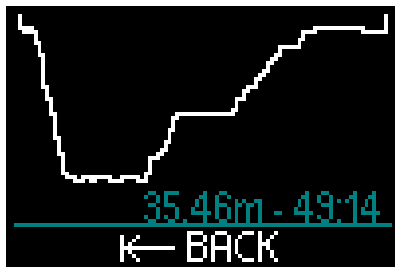

A press-and-release of the push-wheel takes you to the Profile screen, outlining the profile of the dive along with depth and total dive time. A press-and-hold of the push-wheel lets you exit the Profile screen.

Apnea dives

The HUD organizes the Apnea dive log by grouping the individual immersions to a dive session. Included: date, time, maximum depth, the total time of the dive session including any surface intervals, and the temperature.



Use the LogTRAK software to get a detailed look into your profile and to analyze the individual immersions.

Gauge dives

 **NOTE:** If a dive is done in Gauge mode, it is indicated on this page. The Gauge mode contains less information than what's offered in SCUBA mode; therefore, some lines will remain blank in the logbook. Below is an example of a Gauge mode dive and the profile.

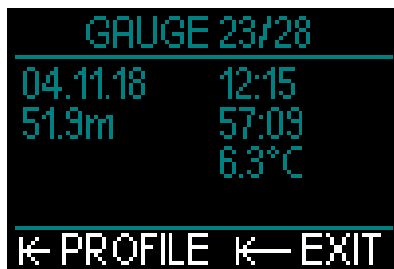

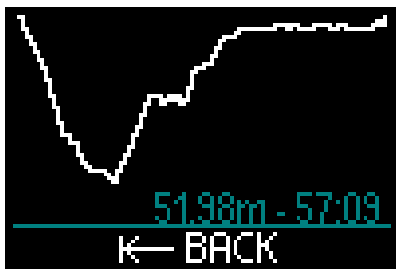

CCR dives

The HUD organizes a CCR dive log on 2 pages. The first page shows Date, Time, Depth, Total Dive Time, the selected algorithm and MB level, Water Temperature and CNS saturation. On the second page you have the profile of the CCR dive.

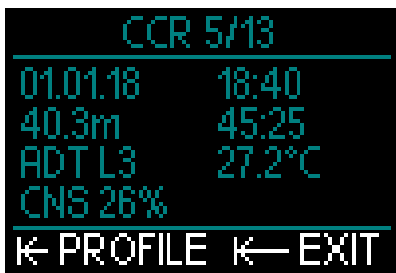

2.6 Communication

The HUD provides a choice of 3 modes for connecting to a desktop, laptop or handheld device when you want to download dive data or upload firmware updates. For more information on interfaces for the HUD, see chapter: Interfaces for the HUD and an Introduction to LogTRAK.

3. DIVING WITH THE HUD

The HUD is a full-featured and highly versatile air integrated dive computer. Its innovative mask-mounted display, designed with precision near-eye optics, is ultra-convenient and offers superior hands-free readability, and its single push-wheel control makes for an incredibly intuitive user experience as you scroll through screens and press to select.

With its choice of 2 algorithms, multiple gas mixes and advanced CCR functionality, the HUD provides decompression calculations for all levels of diving, from casual recreational dives to complex technical dives. It also provides ascent rate calculations and warnings, and its huge memory provides a logbook capable of holding more than 10,000 hours of dive profiles.

During a dive the HUD displays information like depth, dive time, decompression status, water temperature, compass direction, and so much more, while on the surface after a dive, no-fly time, surface interval and prohibited altitude is shown.

⚠ WARNING

- Before each dive check the battery power and recharge the battery as needed.
- Always recharge the battery when the HUD has not been used for a long period of time.
- Low temperatures can affect battery performance. Pay special attention to the battery's charge level during cold-water dives.

⚠ WARNING

Do not start a dive if the low battery warning is displayed on the Surface screen. The computer may fail to function during the dive and this could lead to serious injury or death.

⚠ WARNING

Before each dive, verify that all HUD settings are correct.

3.1 Dive mode at surface

3.1.1 Recreational (factory setting)

If you have not been diving with your HUD for a while (no desaturation remaining) the start screen may appear as shown below:

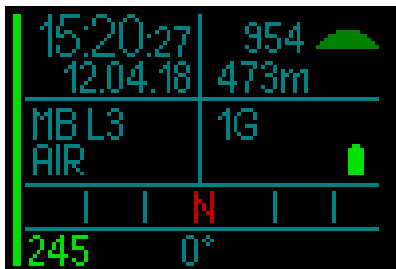

However, in SCUBA mode following a dive, the display may appear as follows:



The current altitude is indicated in the upper right hand corner, along with a symbol.

The no-fly time is shown in red. Above that, the allowable maximum altitude (which the HUD has computed to be incompatible with your current nitrogen saturation levels) is also shown in red.

3.1.2 Multi-gas (Nitrox)

If more than 1 gas is set in the gas table, the multi-gas mode is automatically enabled. The number of preset gases are displayed in the lower-right data box.

For example, below you have 2 gas mixes (2G) preset on a screen showing no recent dives.

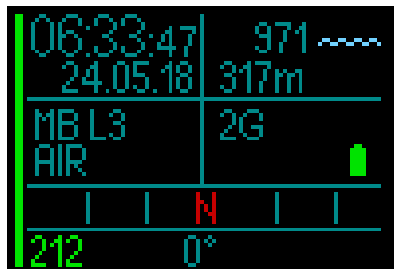

NOTE: The calculations that occur during a dive always include all preset gases.

3.1.3 Trimix

If you add the helium (He) fraction in the gas table all calculations are done based on your settings.

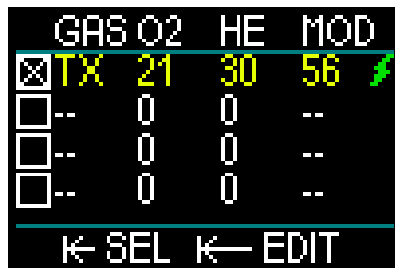

The fraction you select is displayed in the screen's lower-left data box together with the chosen algorithm (MB is the symbol for the ADT algorithm; GF is the symbol for the GF algorithm).

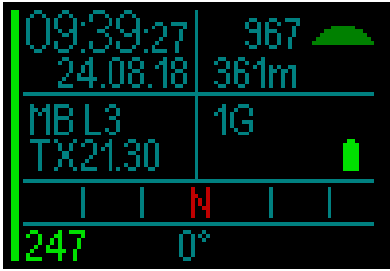

3.1.4 CCR

In CCR mode the display shows the CCR, setpoint 1 and the diluent in the lower left data box. Below that and to the left the pressure of the preset tank is shown.

In the lower right data box the algorithm setting is shown with MB for the ADT algorithm and the GF for the GF algorithm.

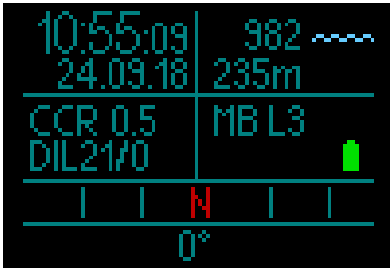

3.1.5 No-fly counter

After a dive the HUD shows the no-fly time and the forbidden altitude ceiling in red. After desaturation is complete this counter disappears.



3.2 Dive display information

Upon immersion, the HUD will automatically start to monitor the dive regardless of what state it was in prior to the immersion.

The HUD automatically switches on as soon as you exceed a depth of 0.8m/3ft.

Since the interval to measure ambient pressure is 10 seconds, in a worse case the HUD will activate no more than 10 seconds after the dive has started. This has no impact on the measured depth.

NOTE: If you would prefer to avoid this delay, simply make sure you switch the HUD on before entering the water.

WARNING

If a yellow exclamation mark appears next to the ambient pressure reading, this means the HUD has an old ambient pressure measurement stored and needs an update. The update occurs automatically and takes only about a minute, at which time the ambient pressure measurement adjusts and the exclamation mark disappears. Without a current ambient pressure measurement the HUD's Dive mode will not function, so before attempting a dive make sure your ambient pressure measurement is current.

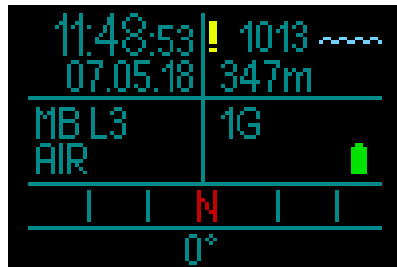

Details on the information displayed on the HUD screen in Dive mode can be found in the following sections.

Surface screen just before the dive:

1 Gas (air) is set; Microbubble setting of L3; tank pressure of 231 bar; fully charged battery.

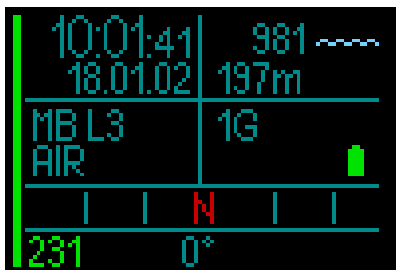

And now the dive begins.

3.2.1 Standard display

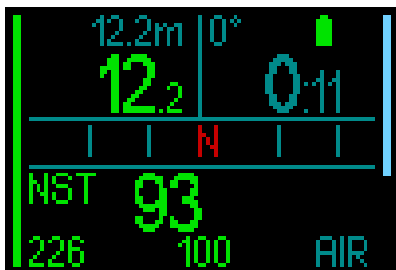

The Standard dive display shows the following information:

Top row, left data box:

- Max Depth
- Current Depth.

Top row, right data box:

- Compass Bearing & Battery Status
- Dive Time.

Middle row:

- Compass, showing the 8 cardinal and intercardinal directions (N, NE, E, SE, S, SW, W, NW) with graduation marks every 15°.

Bottom row (left to right):

- No Stop Time.
- Tank pressure, Remaining Bottom Time, Current Gas Mix.

The bar graph running up the left side of the screen is a graphical representation of the current tank's fill level.

- Full Bar/Green = 200 bar
- Partial Bar/Green = over 110 bar
- Partial Bar/Yellow = 50 to 110 bar
- Partial Bar Red = 25 to 50 bar
- Red Bar (blinking) = less than 25 bar
- A Blue bar starting from the top represents descent speed.

- Green, Yellow and Red bars starting from the bottom represent ascent speed.

For more information about Ascent speed see chapter: **Warning Ascent rate.**

Depth. The depth is given in 10cm resolution in metric mode. When displayed in feet, the resolution is always 1ft. At a depth shallower than 0.8m/3ft, the display shows ---. The HUD's maximum possible operating depth is 120m/394ft.

After a depth of 99.9m/328ft the HUD displays depth in full meters until 120m/394ft.

NOTE: Keep in mind that your HUD is positioned at head level, so there will invariably be differences in depth readings compared to a computer that's worn on a wrist.

Dive time. The dive time is displayed in minutes:seconds. If during the dive you ascend to the surface, the time spent on the surface will only be counted as dive time if you descend again below 0.8m/3ft within 3 minutes. This allows for brief periods of orientation on the surface. While on the surface, the time will not show as progressing but it is running in the background. As soon as you submerge, the time will resume, including the time spent on the surface.

If you spend more than 3 minutes at depths shallower than 0.8m/3ft, the dive will be considered ended, the logbook will close and any subsequent immersion would cause the dive time to start again from zero.

After a dive time of 99:59 the display shows the minutes only. Maximum displayed time is 999 minutes. For dives longer than that, the dive time starts again from 0 minutes.

Only dives longer than 2 minutes are stored in the logbook.

No-stop time. Calculated in real time and updated every 4 seconds. The maximum displayed no-stop time is 199 minutes.

RBT:

RBT (Remaining Bottom Time) is the amount of time you can spend at the current depth and still have enough gas supply to make a safe ascent and reach the surface with the tank reserve. The RBT calculation is based on your current breathing rate, and it accounts for any existing and upcoming decompression obligation as well as for any temperature gradient in the water. It assumes an ascent at the ideal ascent rate (defined in chapter: Ascent rate).

NOTE: In order for RBT to be displayed, the air integration function must be activated using a transmitter properly paired to the HUD.

NOTE: For RBT to be displayed only one gas can be set.

! WARNING

During all dives, perform a safety stop between 3 and 5 meters (10 and 15 feet) for 3 to 5 minutes, even if no decompression stop is required.

NOTE: The display is totally off when the power save mode becomes active (only one battery segment is left) and by pressing the push wheel the display is illuminated for 10 seconds.

3.2.2 Dive display “lite”

If during a dive you decide that you’d prefer a more basic screen display, by rotating the push-wheel you can select a more simple display that shows only depth, dive time, tank pressure (if the transmitter is paired) and no-stop time.

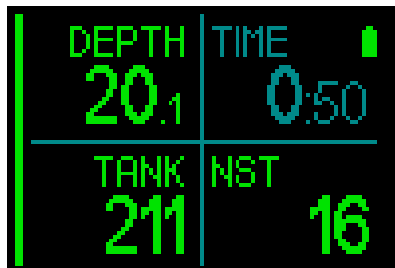

3.2.3 Dive profile

By continuing to rotate the push-wheel you can also choose a dive profile screen. On this screen, along with the graphical dive profile, you get (from left) current depth, temperature and dive time across the top of the screen, and average depth, CNS% and max depth across the bottom of the screen.

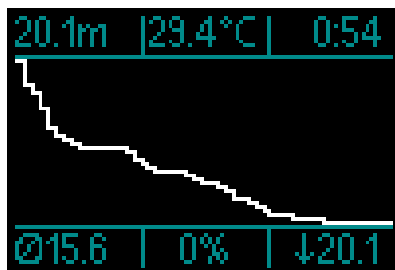

Temperature. The HUD displays water temperature during the dive and air temperature while on the surface.

3.2.4 Navigation

If the Navigation function has been pre-selected, then you can turn directly to the navigation screen which provides information on the direction you need to travel while at depth.



If the Navigation function was not pre-selected, you can activate it by pressing the push-wheel, choosing the Navigation menu, then selecting either the compass or the GPS coordinates which you have set in advance. (see chapter: Navigation)

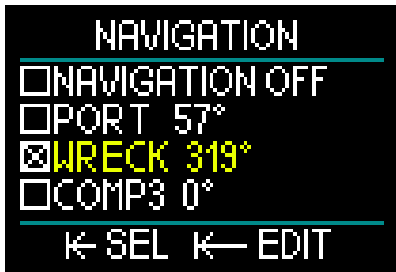

The HUD's GPS functions only at the surface. However, it can be used while in Dive Mode if you need to briefly return to the surface to orient yourself.

The HUD allows you to spend up to 3 minutes on the surface during a dive before ending that dive. This means you can surface, switch your HUD to GPS mode, confirm your position, and then continue your dive.



Applying this scenario to the above screen, upon reaching the surface and switching to GPS mode you would be provided with the following information:

Top of screen:

- "--" (no depth); "44:20" (the current dive time).

Middle of screen:

- "Arrow" (indicates the direction you have to move to come to your waypoint course).
- "0" (your current course).
- i.e., you have to travel to the right until "0" increases to "125," which is the waypoint heading. At that point, 2 arrows will appear, indicating that you are on course.
- "37.03" (the distance to the waypoint).
- "125" (the waypoint heading).
- "GPS" (indicates that the GPS signal is activated / time since the latest GPS signal).

Bottom of screen:

- "Zurichsee" (the name of the waypoint).

 *NOTE: the GPS works only at the surface.*

3.2.5 Deco stop table



By rotating the push-wheel you can also get a display showing all deco stops, including the PDIS stop.

Deco stops are colored in white. The PDIS stop is colored in blue. These stops don't include ascent time.

In addition to deco and PDIS stop info, the screen's top row displays (from left) current depth, local time and dive time, and running down the right side of the screen is the ascent/descent speed bar.

3.3 Alarms and warnings during diving

The HUD can alert you to potentially dangerous situations via warnings and alarms. You can modify the warning and alarm settings in the menus or via a PC interface.

General warnings are shown in yellow, while alarms appear in solid red and/or blinking red. Additionally, audible signals are available when the Sound function is enabled.

WARNING

- When in Gauge mode, all warnings and all alarms are OFF.
- When the HUD is set to SOUND OFF mode, all audible alarms and warnings are switched off.

The HUD's available warnings and alarms follow:

3.3.1 Maximum depth

Maximum depth will trigger a warning. See chapter: **Maximum dive depth warning** to learn how to set the warning depth.

Upon exceeding the maximum depth limit for the first time, the screen's depth will start to blink. This will continue for 30 seconds without changing color. At the same time, an audible alarm will beep for 2 minutes.

NOTE: If the maximum depth limit is exceeded a second time, these warnings will not be repeated.

3.3.2 Dive time

See chapter: **Maximum dive time warning** to learn how to set this warning time.

When the pre-set dive time is reached, the dive time will start to blink for 30 seconds, and an audible alarm will beep for 2 minutes.

3.3.3 No-stop time

If you wish to avoid unintentionally performing a decompression dive, the HUD will activate a warning when the no-stop time reaches 2 minutes.

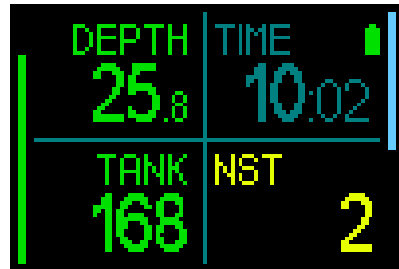

This applies to both L0 no-stop and MB no-stop time (see chapter: Diving with MB levels for more information on MB level diving). This warning gives you the opportunity to start ascending before incurring a decompression stop obligation. If the no-stop time reaches 0 minutes the color changes to red.

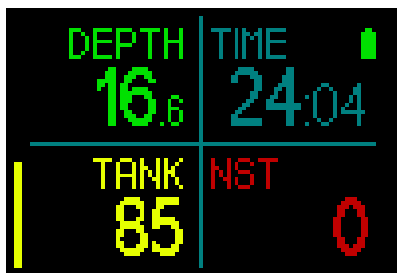

3.3.4 CNS O₂

The HUD tracks your oxygen uptake via the CNS O₂ clock. If the calculated value of CNS O₂ reaches 100%, the HUD will alert you with the red blinking CNS value.

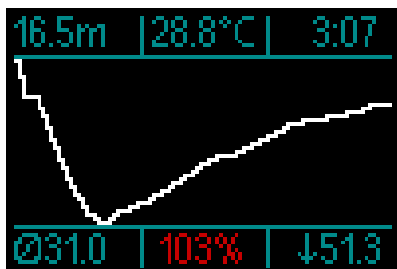

3.3.5 Safety stop timer

If a minimum depth of 10m/30ft has been reached during the dive, at a depth of 5m/15ft the safety stop timer will automatically start a countdown. If you go below 6.5m/20ft, the timer will disappear and the no-stop time is shown again. Upon returning to 5m/15ft, the timer will start again automatically.

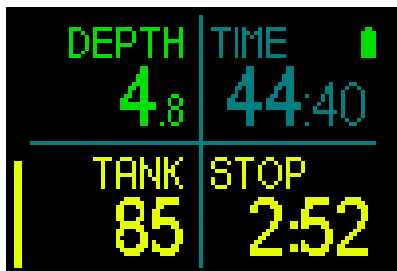

3.3.6 RBT

In order to give you sufficient warning that your gas supply may be running low, the HUD will warn you when the RBT (remaining bottom time) drops to 11 minutes. See chapter: **RBT in display information** for more information on RBT.

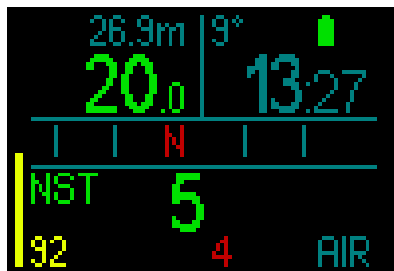

When RBT reaches 11 minutes, the RBT number changes color to yellow. At 6 minutes the RBT number changes to red.

When 0 minutes is reached the RBT starts flashing red: the HUD has computed that if you start your ascent now and ascend at the ideal ascent rate, you will arrive at the surface with just the tank reserve, and any further delay increases the risk that you will run out of your gas supply before reaching the surface.

⚠ WARNING

If the RBT drops to 6 minutes or less, you may not have enough gas supply to complete a safe ascent. Start ascending when you see this alarm.

3.3.7 Ascent rate

As you ascend during a dive, the pressure surrounding you decreases. If you ascend too quickly, the ensuing pressure reduction could lead to microbubble formation. If you ascend too slowly, the continued exposure to high ambient pressure means that you will continue loading some or all of your tissues with nitrogen. Consequently, there is an ideal ascent rate that is slow enough to minimize microbubble formation yet fast enough to minimize the effect of continued loading on your tissues.

The pressure reduction that the body can tolerate without significant microbubble

formation is higher at depth than it is in the shallows: The key factor is not the pressure drop by itself, but rather the ratio of the pressure drop relative to the ambient pressure. This means that the ideal ascent rate at depth is higher than it is in the shallows.

Along these lines, the HUD employs a variable ideal ascent rate. Its value ranges from 3 to 10m/min (10 to 33ft/min) and the actual breakdown by depth range is listed in the table below.

DEPTH		ASC SPEED	
m	ft	m/min	ft/min
0	0	3	10
2.5	8	5.5	18
6	20	7	23
12	40	7.7	25
18	60	8.2	27
23	75	8.6	28
31	101	8.9	29
35	115	9.1	30
39	128	9.4	31
44	144	9.6	32
50	164	9.8	32
120	394	10	33

If the ascent rate is greater than 110% of the ideal value, the ascent speed bar graph turns yellow.

For ascent rates higher than 140%, the ascent speed bar graph changes to red.

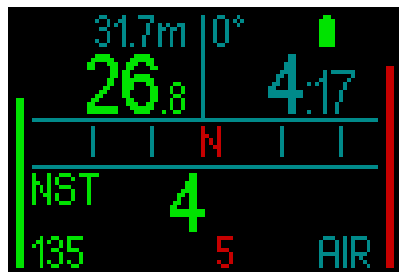

The HUD also provides an audible alarm for ascent rates exceeding 110%: the intensity of the alarm increases in direct proportion

to the degree that the ideal ascent rate is exceeded.

In the event of a too-fast ascent, the HUD may require a decompression stop even within the no-stop phase because of the danger of microbubble formation.

From great depths a slow ascent may cause heightened saturation of tissues and an extension of both decompression duration and total ascent time. At shallow depths, a slow ascent may shorten the decompression duration.

WARNING

The ideal ascent rate must not be exceeded at any time, since this could lead to microbubbles in the arterial circulation which could cause serious injury or death.

The alarm persists for as long as the ascent rate is 110% or more of the ideal ascent rate.

3.3.8 MOD/ppO₂

WARNING

- The MOD should not be exceeded. Disregarding the alarm can lead to oxygen poisoning.
- Exceeding a ppO₂ of 1.6bar can lead to sudden convulsions resulting in serious injury or death.

If you get into a critical area of the MOD (meaning that your current ppO₂ is higher than your MAX ppO₂ minus 0.2bar, but smaller than your MAX ppO₂) the depth changes color to yellow.

If your current ppO₂ is higher than your MAX ppO₂ but still smaller than your MAX ppO₂ plus 0.2 bar, the depth is shown in red.

The depth starts blinking in red if your current ppO₂ is higher than your MAXppO₂ plus 0.2 bar.

The beeping will continue for as long as you stay deeper than the MOD.

3.3.9 Entering decompression

The HUD will activate a warning when the first mandatory decompression stop appears. (Decompression stops will differ depending on the MB level setting. See chapter: Diving with MB levels)

This alerts the diver to the fact that a direct ascent to the surface is no longer possible. This warning applies to dives with the HUD set to LO-L5.

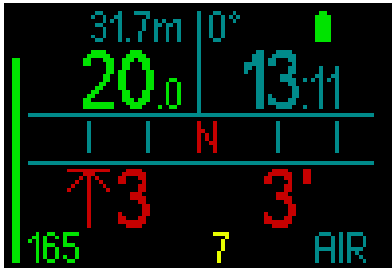

Decompression information. When the HUD calculates the need for a mandatory decompression stop, it shows you how deep your deepest stop is (lower left side of the screen, showing an arrow alongside 3 meters in red). Also, it gives you the total ascent time (3 minutes, shown on the lower right).

NOTE: After a total ascent time of 200 minutes, the display will show “---”.

A summary of all deco stops required for a dive can be found on the HUD's Deco table screen. For more information, see chapter: 3.2.5. Deco table.

When diving with an MB level higher than L0 and faced with a potential deco stop, if you ascend for 3 min more than 0.5m / 2ft above the deepest required MB level stop, the HUD reduces your MB level to the next possible level. The lite display will show the new active MB level (in red under the current gas).

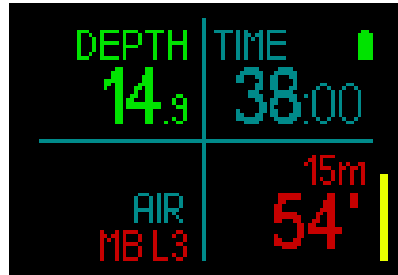

WARNING

Violating a mandatory decompression obligation may result in serious injury or death.

If, when faced with a decompression situation, you ignore a required deco stop, the HUD will show SOS at the surface and will store this information in the logbook.

3.4 Diving with MB levels

Microbubbles (MB) are tiny bubbles that can build up inside a diver's body during any dive and normally dissipate naturally during an ascent and on the surface after a dive. Dives conducted within no-stop times and the observance of decompression stops do not prevent the formation of microbubbles in the venous blood circulation.

Dangerous microbubbles are those migrating into the arterial circulation. The reasons for the migration from the venous blood circulation to the arterial circulation can be because of a build-up of microbubbles collecting in the lungs. SCUBAPRO has equipped the HUD with technology to help protect divers from these microbubbles.

With the HUD you can choose – according to your specific needs – a MB level that will provide a level of protection from microbubbles. Diving with MB levels includes additional ascent stops which slow the ascent process, giving the body more time to desaturate. This works contrary to the formation of microbubbles and may increase safety.

The HUD features 6 microbubble levels (L0-L5). Level L0 corresponds to SCUBAPRO's well-known decompression model ZH-L16 ADT and does not require additional stops due to microbubble formation. Levels L1 to L5 offer additional protection from microbubble formation, with level L5 offering the highest level and most protection.

Similar to the display of information during decompression dives or dives within no-stop time, the HUD displays the depth and duration of the first level stop as well as the total time of ascent as soon as the MB no-stop time has run out. As the MB no-stop time is shorter than the ordinary no-stop time, you will be required to perform a stop sooner than a diver using level L0.

If you ignore a required stop, the HUD will simply step down to a lower MB level. In other words, if you choose level L4 prior to the dive, and during the dive you ignore the L4's recommended stops, the HUD will automatically adjust the setting to level L3 or lower.

3.4.1 Comparison of dives with MB level L0 and MB level L5

When two HUD dive computers are used simultaneously, with one unit set to a MB level of L5 and the other to a MB level of L0, the no-stop time for the L5 unit will be shortened and more stops will be required before the L5 diver has the same obligation of a decompression stop as the L0 diver. These additional stops help dissipate microbubbles.

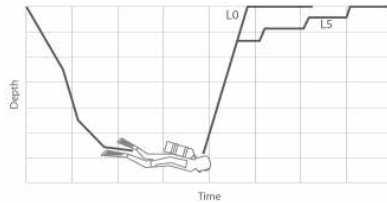

Changing the MB level during diving.

The HUD gives you the ability to change the MB level during a dive. Once the change is made, the HUD's decompression schedule will automatically adjust to the new MB setting.

Switching the MB level at depth works the same way as setting the MB level on the surface. For information on setting the MB level see chapter: 2.2.1.3. MB Level.

3.4.2 **PDIS (Profile Dependent Intermediate Stop)**

Introduction to PDIS

The main purpose of a dive computer is to track your nitrogen uptake and recommend a safe ascent procedure. Diving within the so called no-stop limits means that at the end of the dive you can ascend directly to the surface, albeit at a safe ascent rate, while for dives outside of the no-stop limit (so-called decompression dives), you must perform stops at certain depths and allow time for excess nitrogen to be expelled from your body before finishing the dive and re-surfacing.

In both cases, it can be beneficial to stop for a few minutes at an intermediate depth between the maximum attained depth during the dive and the surface or, in case of a decompression dive, the first (deepest) decompression stop.

An intermediate stop of this kind is beneficial as soon as the ambient pressure at that depth is low enough to ensure that your body is predominantly off-gassing nitrogen, even if under a very small pressure gradient. In such a situation, you can still cruise along the reef and enjoy the dive while your body gets a chance to slowly release nitrogen.

In recent times, so called “deep” stops have been introduced in some dive computers and tables, defined as half the distance from the dive’s maximum depth and the surface (or the lowest decompression stop). Spending 2 or 15 minutes at 30m/100ft would result in the same deep stop at 15m/50ft.

With PDIS, as the name suggests, the HUD interprets your dive profile and suggests an intermediate stop that is a function of your nitrogen uptake so far. The PDI stop will therefore change through the course of the dive to reflect the continuously changing situation in your body. Along the same lines, PDIS will account for the accumulated nitrogen from previous dives; hence, PDIS is also repetitive-dive dependent. Conventional deep stops completely ignore these facts.

The following figure quantifies the extent of PDIS and illustrates its dependence on cumulative nitrogen uptake for 2 sample

dive profiles. This figure also demonstrates the conceptual difference between PDIS and the rather rudimentary “deep” stops.

Specifically, the figure compares 2 dive profiles to a maximum depth of 40m/132ft that are otherwise very different.

Profile 1 stays at 40m/132ft for 7 minutes, then ascends to 30m/100ft for 3 minutes, followed by 12 minutes at 20m/65ft. Profile 2 stays less than 2 minutes at 40m/132ft, then ascends to 21m/69ft and stays there for 33 minutes. Both dive profiles are no-stop dives to the limit of entering decompression.

The solid line represents the PDIS depth as displayed on the computer screen during the course of the dive for profile 1, the broken line represents the PDIS depth as displayed on the computer screen during the course of profile 2. One can see that the displayed PDIS depth increases as more nitrogen is accumulated in the body, but does so very differently in the 2 dives due to the different exposure in the 2 profiles. The PDI stop is carried out at 25 minutes for profile 1 and at 37 minutes for profile 2, followed by the safety stop at 5m/15ft.

The line made up of small solid dots, on the other hand, represents the depth that would be displayed by a computer following the conventional deep stop method, and it would be the same for the 2 dive profiles. Deep stops completely ignore any facts about the dives themselves aside from max depth.

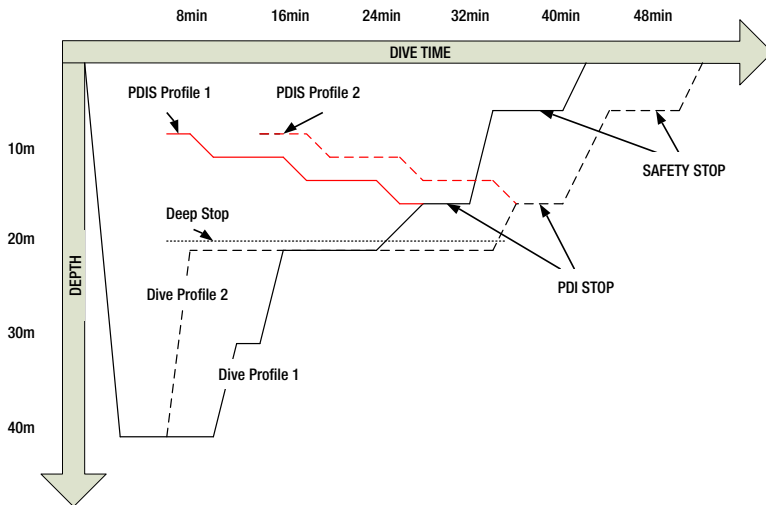

How does PDIS work?

The mathematical decompression model in the HUD, called ZH-L16 ADT MB PMG, tracks your decompression status by dividing your body into 16 so-called compartments and mathematically following the uptake and release of nitrogen in each with the appropriate laws of physics. The various compartments simulate parts of your body such as central nervous system, muscles, bones, skin and so on.

The depth of the PDI is calculated as that at which the leading compartment for the decompression calculation switches from on-gassing to off-gassing, and the diver is advised to perform a 2-minute stop above the displayed depth (this is the opposite of a decompression stop, where you are asked to remain just beneath the displayed depth). During this intermediate stop, the body is not taking up any more nitrogen in the leading compartment, but rather releasing nitrogen (though under a very small pressure gradient). This, combined with the relatively high ambient pressure, inhibits bubble growth.

It should be noted that the 4 fastest compartments, up to 10-minute half-times,

respectively, are not considered for the determination of the PDI stop depth. This is due to the fact that these compartments are only “leading” for very short dives, for which an intermediate stop is not required at all.

NOTE: The PDI stop is not a mandatory stop, and it is NOT a substitute for the 3- to 5-minute safety stop at 5m/15ft.

WARNING

Even when performing a PDI stop, you still MUST perform a safety stop at 5m/15ft for 3 to 5 minutes. Performing a 3- to 5-minute stop at 5m/15ft at the end of any dive remains the best thing you can do for yourself!

Special considerations when diving with more than one gas mixture (2G)

Switching to a higher oxygen concentration mix during the dive influences the PDI stop. This needs to be accounted for, in line with the predictive nature of multi-gas handling in ZH-L16 ADT MB PMG.

When diving with more than one gas mixture, the HUD displays the PDIS depth according to the following rules:

- If the PDI stop calculated for the bottom mix (gas 1) is deeper than the switch depth, then this calculated value is displayed.
- If the PDI stop calculated for gas 1 is shallower than the switch depth to gas 2, then the displayed PDI stop is a function of gas 2.

In case of a missed gas switch, the HUD reverts to the PDI stop for the actively breathed mix.

Diving with PDIS

 **NOTE:** To use the PDIS feature, you must enable PDIS (see chapter: PDIS.).

When the calculated PDI stop is deeper than 8m/25ft, the HUD shows it on the display and continues to do so until you reach the displayed depth during an ascent. The displayed value changes during the dive as the HUD tracks the uptake of nitrogen in the 16 compartments and updates the PDIS depth accordingly to reflect the optimum at all times.

The PDIS depth is shown in blue.

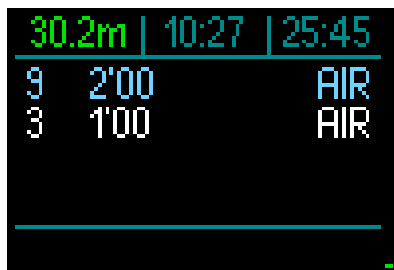
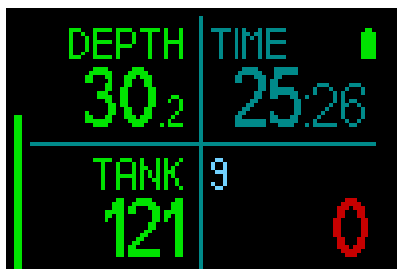
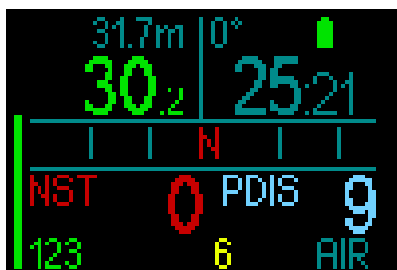

During a no-stop dive, as soon as you reach that depth during an ascent, a 2-minute countdown will appear.

In the deco table the counter appears in any case.

You can have one of these 3 situations.

- You have spent 2 minutes within 3m/10ft above the indicated depth. The countdown timer disappears and the deco table shows the PDIS stop in yellow to say that the PDIS has been performed.
- You have descended more than 0.5m/2ft below the PDIS. The countdown timer disappears and will reappear again, starting at 2 minutes, the next time you ascend to the PDIS depth.
- You have ascended more than 3m/10ft above the PDIS. The PDIS value and countdown timer disappear and in the deco table the PDIS stop disappears which indicates that PDIS has not been performed.

 **NOTE:** The HUD issues no warnings relating to a missed PDI stop.

When diving with MB levels, PDIS follows the same rules as described above. MB levels, however, introduce stops earlier and deeper than the L0 base algorithm. As such, the PDIS display may be delayed and, for certain dives, it may not be displayed at all. This, for example, would be the case for a shallow dive with air (21% oxygen) and a MB level L5.

3.5 Altitude diving

3.5.1 Altitude warning after a dive

Climbing to altitude is similar to starting an ascent from a dive: you expose your body to a lower partial pressure of nitrogen and you start off-gassing. After a dive, given the higher nitrogen loading in your body, even reaching an otherwise negligible altitude can potentially cause decompression sickness. Consequently, the HUD constantly monitors the ambient pressure and uses it to evaluate your nitrogen loading and off-gassing. If the HUD notices a drop in ambient pressure not compatible with your current nitrogen loading, it will activate a warning (altitude starts blinking in blue) to alert you of a potentially dangerous situation.

The HUD counts down remaining saturation and indicates this on the Surface screen with the no-fly time until the available saturation is no longer dangerous during a flight or when crossing over a mountain pass.



The allowable altitude (beyond which the HUD has computed to be incompatible with your current nitrogen saturation levels) is displayed above the no-fly time in red.

The current altitude can be checked in the menu. See chapter: Settings / Altimeter.

Altitude and the decompression algorithm

Atmospheric pressure is a function of altitude and of weather conditions. This is an important aspect to consider for diving, because the atmospheric pressure surrounding you has an influence on the on-gassing and off-gassing of nitrogen. Above a certain altitude, the decompression algorithm has to change to account for

the effect of the change in atmospheric pressure.

The HUD measures the atmospheric pressure and calculates saturation and off-gassing on the surface as well as when diving.

WARNING

At an altitude of around 4000m/13,300ft the HUD will not allow you to start a dive.

NOTE: You can check your elevation by activating the altitude meter. Refer to chapter: Altimeter to learn how to do so.

NOTE: The HUD deals with altitude automatically. It monitors the atmospheric pressure every 60 seconds and if it detects a sufficient drop in pressure, it indicates the new altitude range and, if applicable, the prohibited altitude range. It also indicates the no-fly time which, in this case, is an adaptation time to the new ambient pressure. If a dive is started during this adaptation time, the HUD considers it a repetitive dive since the body has residual nitrogen.

3.5.2 Prohibited altitude

Going to altitude, as well as flying after diving, exposes your body to a reduced ambient pressure. In a manner similar to no-fly time, the HUD advises you of the safe altitudes you can reach after a dive, and those which are not safe. If you have to drive over a mountain pass to return home after a dive, this information can be quite important.

Decompression dives in mountain lakes over 4000m/13300ft

If atmospheric pressure is below 610mbar (altitude higher than 4000m/13300ft), no decompression calculation is carried out by the HUD, and it will not start in Dive mode. In addition, the dive planner is not available in this altitude.

3.6 Diving with nitrox

Nitrox is the term used to describe breathing gases made of oxygen-nitrogen mixes with the oxygen percentage higher than 21% (air). Because nitrox contains less nitrogen than air, there is less nitrogen loading on the diver's body at the same depth as compared to breathing air.

However, the increase in oxygen concentration in nitrox implies an increase in oxygen partial pressure in the breathing mix at the same depth. At higher than atmospheric partial pressures, oxygen can have toxic effects on the human body. These can be grouped into 2 categories:

1. Sudden effects due to oxygen partial pressure over 1.4bar. These are not related to the length of the exposure to high oxygen partial pressure. Sudden effects can vary and depend on the exact level of partial pressure they happen at. It is commonly accepted that partial pressures up to 1.4bar are tolerable during the active part of the dive, and maximum oxygen partial pressures up to 1.6bar during the decompression.

2. Long exposure effects to oxygen partial pressures over 0.5bar due to repeated and/or long dives. These can affect the central nervous system and cause damage to lungs or to other vital organs. Long exposures can be divided between more severe Central Nervous System effects and less dangerous long-term Pulmonary Toxicity effects.

The HUD treats high ppO_2 and long exposure effects in the following ways:

- Against sudden effects. The HUD has an MOD alarm set for a user-defined ppO_2 max. As you enter the oxygen concentration for the dive, the HUD shows you the corresponding MOD for the defined ppO_2 max in the 4th column of the gas table.

	GAS	O2	HE	MOD	
<input checked="" type="checkbox"/>	AIR	21	0	56	↗
<input type="checkbox"/>	NX	50	0	18	↗
<input type="checkbox"/>	O2	100	0	6	↗
<input type="checkbox"/>	--	0	0	--	

← SEL ← EDIT

The default value of ppO_2 max from the factory is 1.4bar. This can be adjusted to your preference between 1.3 and 1.6bar. Please refer to chapter: ppO_2 max for more information on how to change this setting.

- Against long exposure effects. The HUD "tracks" the exposure by means of the CNS O_2 clock. At levels of 100% and higher there is risk of long exposure effects and, consequently, the HUD will activate an alarm when this level of CNS O_2 is reached. Note that the CNS O_2 clock is independent of the value of ppO_2 max set by the user.

The CNS O_2 clock increases when the oxygen partial pressure is higher than 0.5bar, and decreases when the oxygen partial pressure is lower than 0.5bar. Hence, while on the surface breathing air you will always be decreasing the CNS O_2 clock. During the dive, the depth at which 0.5bar is reached for various mixes is as follows:

Air:	13m/43ft
32%:	6m/20ft
36%:	4m/13ft

3.6.1 Technical diving

You should be properly trained and certified by a recognized agency in technical diving before using the HUD for technical diving. Decompression diving, diving with high oxygen percentage blends, multi-gas diving and mixed gas diving all require skills and demand a level of diving know-how that only specific training and education can provide. A dive computer is an electronic instrument that cannot make decisions for you and cannot take all parameters into account during a dive.

In technical diving a dive computer is not the primary instrument to follow during the dive. Before the dive you must make a plan, and then follow it during the dive. If your plan and your computer show different schedules, always follow the more conservative one.

WARNING

Both the HUD Trimix model and trimix diving are developed for healthy, physically fit, advanced divers. You should have regular medical check-ups with a specialized physician, confirming your physical aptitude for diving. This is even more important for technical diving.

Patience is a very important characteristic to maintain when conducting complex dives. It is necessary to build your personal depth limit and decompression amount based on your real diving experience and then increase little by little as you gain experience.

The HUD is not designed for commercial diving. Special procedures such as surface supplied gas, diving in a heated suit, decompressing in a chamber or bell and long, high workload dives may cause an algorithm to calculate incorrectly or even disturb the operation of the HUD dive computer.

Never dive without a backup instrument. It is imperative to always have backup instruments for depth, time and tank pressure, as well as a dive table with you while diving.

Plan your dives in advance and cross check your plan with another commercial planner program or table. Your dive plan should always include reserve gas amounts sufficient to handle emergencies and/or delays. Always make bailout tables for the dive.

Technical diving is not for everyone. Decompression diving, especially with helium mixes, will always have a higher inherent potential for an accident, which could lead to permanent injury and death. The risk may be higher due to differences in an individual's physical condition, environmental conditions, human errors, etc. If you are not willing to take the risk, don't dive!

3.6.2 Diving with multiple gas mixtures

The HUD is equipped with the ZH-L16 ADT MB PMG algorithm. PMG stands for Predictive Multi-gas, meaning that when you program more than one gas mixture, the HUD will predict the switch to the higher oxygen concentration gas at the depth that you specified and alert you at all times with a comprehensive decompression schedule of all the gas mixtures that you programmed.

In other words, you get full credit at any point during the dive for all the extra gas mixtures that you are carrying with you.

⚠ WARNING

VERY IMPORTANT!

⚠ Diving with multiple gas mixtures represents a much higher risk than diving with a single gas mixture, and mistakes by the diver may lead to serious injury or death.

⚠ During dives with multiple gas mixtures, always make sure you are breathing from the tank that you intend to use. Breathing from a high oxygen concentration mix at the wrong depth can kill you.

⚠ Mark all of your regulators and tanks so that you cannot confuse them under any circumstances.

⚠ Before each dive and after changing a tank, ensure that each gas mixture is set to the correct value for the corresponding tank.

⚠ Set only gas mixes which you take with you and plan to use.

⚠ Get the proper training and certifications to make multi-gas dives prior to making them by yourself.

The HUD enables you to use up to 8 gas mixtures during the dive.

- The ppO_2 max is the same for all preset gases.
- The MOD for tanks 2 through 8 are the switch depths for those gases. This is what the HUD uses for its calculations, warnings and suggested switch points.

👉 NOTE: Start breathing from the tank with the new gas mixture before confirming a switch.

⚠ WARNING

Always make sure you are switching to the intended gas. Failure to do so may result in serious injury or death.

The following chapters about gas switching are shown with 2 gas mixtures enabled. However, more than two mixes enabled work similarly.

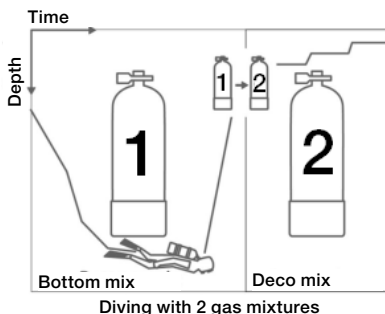

Switching gas mixture during the dive

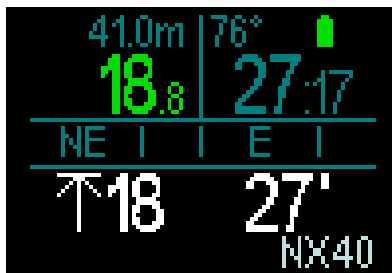

During the ascent phase, when you reach a depth corresponding to the MOD of a gas other than the one you are currently using, the HUD will suggest that you perform the switch. The proposed gas flashes white in the lower right corner. You have 20 seconds to respond to this message and make the switch; otherwise, the HUD will stop suggesting a gas switch and recalculate your decompression obligations and TAT. If you want to use the gas later you will have to activate it manually.

To confirm the gas switch, press-and-hold the push-wheel. After the switch is confirmed, the new gas is displayed in the lower right corner.

Switching back to a gas mixture with lower oxygen concentration

There may be situations where you have to switch back to a tank with lower oxygen concentration. This can happen, for instance, if you want to descend again below the MOD of the higher oxygen concentration gas, or if you have run out of gas during decompression. At this point you can manually initiate the gas switch by accessing the gas table and selecting the gas you prefer.

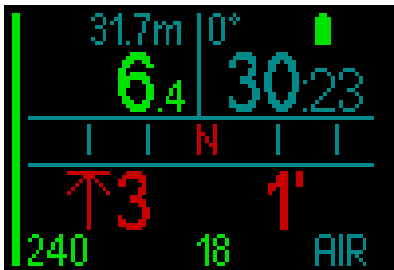
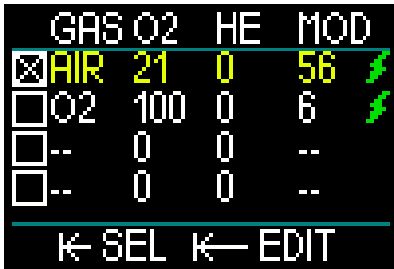

Submerging below the MOD after a gas switch.

If, after switching to gas 2, you inadvertently drop again below the MOD for that mixture, the MOD alarm (depth value shown in red and blinking) will immediately be activated. In this case, you would either switch back to gas 1 or ascend above the MOD for gas 2.

Adding an unplanned gas

In the case of an emergency, it could happen that you would need to use a gas from your buddy or an additional stage tank. The HUD provides the option to add this gas to the last line of your gas table during a dive. It is marked in green.



After adding this gas the deco schedule will be updated immediately.

⚠ WARNING

NEVER set a gas mix or breathe a gas mix that you have not mixed or checked yourself. Breathing an incorrect gas mixture can be lethal!

👉 NOTE: During diving you cannot pair this gas.

3.6.3 Diving with trimix

WARNING

VERY IMPORTANT!

△ When breathing compressed air or EAN nitrox during a dive, the diver accepts a certain level of risk. When breathing a trimix gas or other gas mixes during a dive, the risk level increases.

△ We have used all relevant data and the most recent hyperbaric research on trimix diving to bring the risk level of our trimix algorithm to the lowest possible acceptable level. Nevertheless, we can in no way guarantee that breathing nitrox, trimix, mixed gases or compressed air during a dive using our trimix algorithm will eliminate or prevent the risk of serious injury or death from decompression sickness, oxygen toxicity or some other inherent risk.

△ The trimix diver using our trimix algorithm on our dive computers should be aware of the risk level and be willing to accept that personal risk and bear the full legal responsibility of such risks. If the diver is not willing to accept those risks, including serious injury or death, then he or she should not dive with our Trimix mode.

△ Never risk your life on only one source of information. Eventually, every computer has the potential to fail, so do not depend exclusively upon it and always have a plan for how to handle failures. Use a redundant dive computer, carry backup tables and depth/time instrumentation. If you make riskier dives, obtain the proper training from a recognized agency to gain the required technical skills and experience needed for this type of diving. Computer technology is never a substitute for knowledge and training

WARNING

Before performing trimix dives with the HUD you should practice no-stop recreational diving to become accustomed to the interface and functions of the dive computer.

Maximum Operating Depth

The Maximum Operating Depth (MOD) is calculated from the oxygen content in the gas mix. The ppO_2 that is selected by the user is divided by the oxygen fraction. The result will be pressure, which is converted to depth. The maximum MOD is valid for

all gases (except gas mixes with an oxygen content higher than 80%. This gases always have a ppO_2 of 1.6bar).

When diving with trimix, please also take care regarding the Minimum Operating Depth. Your gas mix should always have enough oxygen to safely relate to the current depth.

WARNING

Altitude diving with hypoxic mixes requires proper acclimatization. Adaptation to lower ppO_2 levels is a slow process requiring your body to produce more red blood cells. The adaptation time is personal and cannot be directly calculated. Desaturation due to pressure drop when arriving at altitude is another factor (see chapters: Altimeter and Altitude diving).

Gas selection

In technical diving, especially with trimix blends, the decompression efficiency becomes extremely important. Gas mixes with high helium content and low oxygen content are not well-suited for decompression.

For example, where two decompression mixes are, in most cases, enough when air or nitrox is used as a bottom gas, in the case of trimix, optimal off-gassing requires more decompression mixes.

So, the HUD's PMG algorithm is a critical component to a diver's ability to take full advantage of the benefits of trimix diving.

Tank 1 is always the starting gas from the surface. When you have set more than one tank, you may change gases during the dive manually, or when the HUD suggests it.

The minimum O_2 setting for tank T1 is 18%. This is due to the limitation that a dive must begin with gas 1. To ensure an adequate supply of oxygen to the body, the gas used at the beginning of the dive must contain enough oxygen (you can use a travel mix or one of the decompression gases) as is required for Tank 1.

⚠ WARNING

Heavy work while at the surface or at shallow depths while breathing with less than a 21% oxygen fraction may cause a loss of consciousness and lead to drowning.

The minimum O₂ setting for tanks other than tank 1 is 8%.

⚠ WARNING

Low oxygen fraction settings may allow greater MOD values. The dive computer cannot evaluate your skills, experience or condition to dive the MOD which is showing. Dive only at depths that your certification allows.

The HUD calculates the maximum possible helium fraction by subtracting the oxygen fraction from 100%.

⚠ WARNING

Helium reduces the narcotic effect of the mix, but does not remove it. At great depths, helium may also cause an effect called “helium tremors” or HPNS (High Pressure Nervous Syndrome).

The gas summary table is practical when handling multiple gas mixtures. It can be accessed during a pre-dive check as well as any time during the dive.

👉 **NOTE:** *The Smart transmitter communicates the pressure signal frequently only from the actively used tank. When the tank is not used within 5 minutes, the transmitter goes into a power save mode and the pressure update to the gas graph may take longer.*

PDIS for both N₂ and He

The Profile Dependent Intermediate Stop (PDIS), as described in the chapter: **PDIS (Profile Dependent Intermediate Stop)**, has been extended to both nitrogen and helium gases. The optimal off-gassing depth will be indicated when PDIS is enabled. PDI stops are not obligatory, but will potentially assist in reducing possible bubble formation.

3.6.4 CCR mode

The CCR (Closed Circuit Rebreather) system is probably older than the Open Circuit Scuba system because the basic operating principle with manual control didn't require a highly reliable regulator system.

The CCR system also uses the gas more efficiently than an open loop system, because the oxygen is added to the breathing loop only as needed. Respectively, the carbon dioxide generated by the body is bound to calc at the scrubber. As a side effect the CCR system is nearly bubble-free, which can be beneficial when engaged in photography or observing fish under water.

In the CCR system the breathing gas ppO₂ (partial pressure of the oxygen) is kept constant. The CCR system itself takes care of this. Compared to an open loop system the constant ppO₂ converts to a variable nitrox mix at different depths.

For example, a ppO₂ setting of 1.0bar is comparable to an open loop 50% nitrox mix at a depth of 10m/33ft in salt water.

⚠ WARNING

All rebreathers require unit specific education before using them. Get the proper certifications and follow manufacturer recommendations and procedures when diving with a rebreather unit. Deviations may lead to severe injury or death. Rebreathers use multiple gases, bailout procedures which are equal to gas switching, and many technical diving techniques. Therefore, all considerations and warnings of the previous chapters apply to rebreather diving.

3.6.4.1 Enabling the CCR mode

To access the HUD's CCR mode, from the Main menu scroll to Settings and press-and-release the push-wheel. From there select Dive – press-and-release, then Modes – press-and-release, which takes you to the screen below.

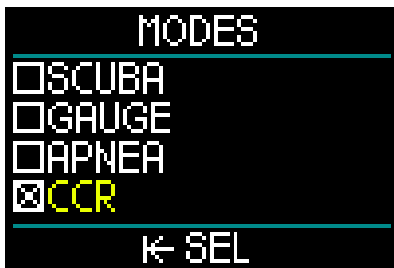

Scroll down to select CCR and press-and-release. This will return you to the Dive screen.

At this point, if you press-and-hold the push-wheel twice you will return first to the Settings screen, and then back to the Main menu.

Here you will notice that, with the CCR mode activated, like it is now, an additional CCR setting appears at the top of the Main menu screen.

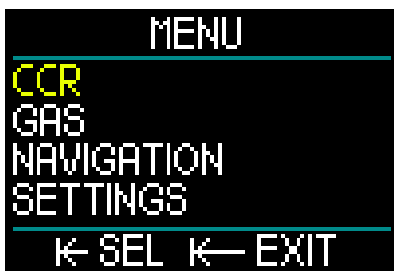

By selecting CCR and press-and-releasing the push-wheel, you enter the CCR settings sub-menu.



In this sub-menu you can preset your setpoints (which are also editable during diving) and you can choose if you want to start with setpoint 1, setpoint 2 or a bailout gas.



The first setpoint (SP1) is selectable from 0.3 to 0.95 bar.



This screen shows a sample of a setpoint 2 setting. The setpoint 2 is selectable from 1.0 to 1.6 bar.

This sub-menu is available while diving and you can use it to switch to the bailout gas at any time and in any situation.

You will find a summary of your CCR settings displayed in the lower-left data box on the Surface screen.

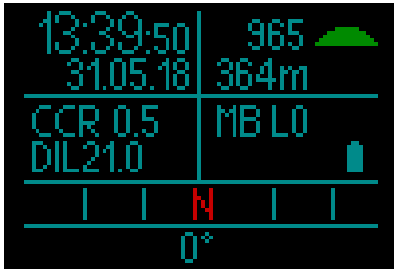

☞ **NOTE:** if the GF algorithm has been chosen you will find this data in place of the Microbubble (MB) data on the Surface screen.

The pairing to your diluent and oxygen of the CCR system is similar to pairing the gas of an Open Circuit system. For more information, see chapter: Mounting and Pairing the High pressure transmitter.

	GAS	O2	HE	MOD
<input type="checkbox"/>	OXY	100	0	--
<input type="checkbox"/>	DIL	21	0	13
<input checked="" type="checkbox"/>	AIR	21	0	56
<input type="checkbox"/>	--	0	0	--

← SEL

☞ **NOTE:** The gas table, while in activated CCR mode (shown above), is similar in appearance to the SCUBA mode, only instead of setting your gas you set your oxygen and your diluent. The gases starting on row 3 are your bailout gases.

Switching the setpoint (SP).

To switch from SP1 to SP2 or to OC, press-and-hold the push-wheel during diving.

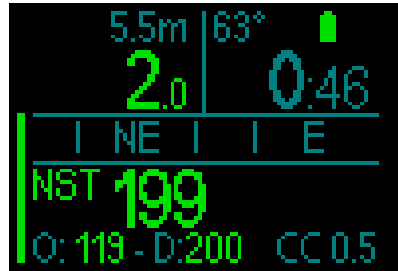

Example of screen display with SP1 shown on bottom row/right and oxygen/diluent on bottom row/left.

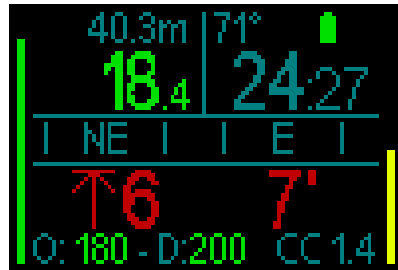

Example of screen display with SP2 shown on bottom row/right and oxygen/diluent on bottom row/left.

Using a bailout gas

To use a bailout gas you first have to set the gas table.

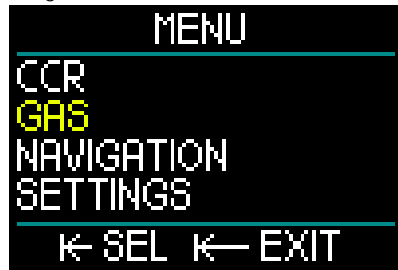

Once the gas table is set with OC gases, now you can switch during a CCR dive to OC, at which time the first OC gas listed on the gas table will be activated. Usage is identical to SCUBA mode.

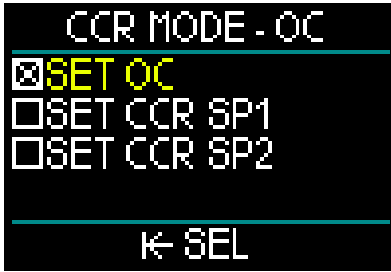

Starting with the switch to OC, all preset OC gases are included in the decompression schedule and the best breathing gas will be suggested.

NOTE: Always prepare the gas table in advance with your bailout gases.

NOTE: For a quick switch to your preset bailout gas you can use the press-and-hold function of the push-wheel while diving

How to use the setpoints

The dive start setpoint (SP1) has a selectable range from 0.3bar up to 0.95bar ppO₂. The bottom setpoint (SP2) has a range from 1.0bar up to 1.6bar ppO₂ and this is switched normally active on the way to the bottom, or when the bottom depth is reached.

The SP switch depth is suggested by the dive computer the same way the gas switches are suggested in open circuit mode (predictive gas switching).

The switch points are determined by the equivalent oxygen contents in open circuit mode. So, on the way down the switch point is reached when the equivalent content of the gas at that depth reaches the diluent O₂ level.

For example, with a SP1 of 0.5bar of the air diluent the depth would be approximately 13.8m/45.3ft in salt water.

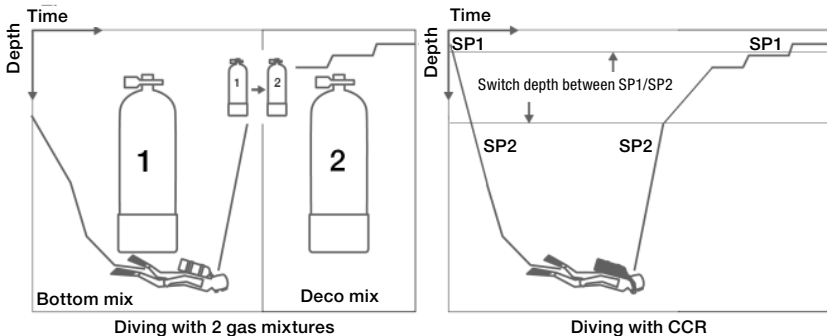

To switch between the setpoints and OC press-and-hold the push-wheel during the dive.

3.7 Gauge mode

When the HUD is set to Gauge mode, it will only monitor depth, time, and temperature, and will not carry out any decompression calculations. You can only switch to Gauge mode if the computer is completely desaturated. All audible and visual warnings and alarms, other than the low battery, tank reserve, max depth and max dive time, are turned off.

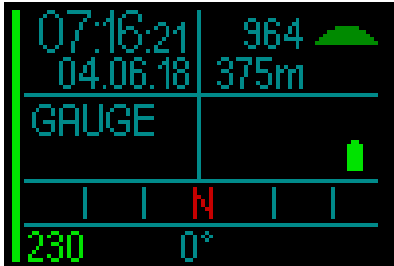

⚠ WARNING

Dives in Gauge mode are performed at your own risk. After a dive in Gauge mode you must wait at least 48 hours before diving using a decompression computer.

During a dive there are 2 displays available: the standard display, and the profile.

In addition to the gas pressure bar on the left side of the screen, you have the ascent rate bar shown on the right side.



By rotating the push-wheel you switch to the profile display.

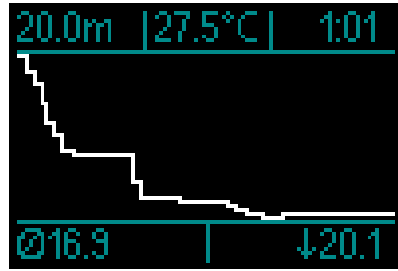

While diving you can access the Navigation menu to use the compass, or the GPS after surfacing.

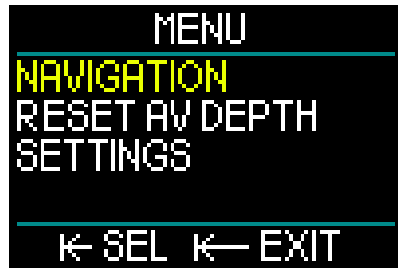

During a dive in Gauge mode, the HUD displays the average depth in the corner at the top of the left side. This can be reset by entering the Settings menu and selecting Reset Av Depth.



During the dive you also have access to the following Settings' Display menu.



When on the surface in Gauge mode, the HUD will not show no-fly time or maximum allowable altitude. It will, however, display a surface interval up to 24 hours and a 48-hour lock time. This lock time is also the time during which you cannot switch back to computer mode.

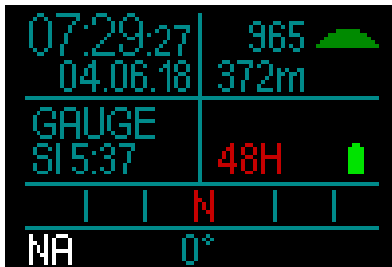

3.8 Apnea mode

The HUD features an advanced Apnea mode, with an apnea dive display that spotlights the most important information an apnea diver needs.



Apnea screen showing maximum depth, average depth and time.

The HUD measures the depth in Apnea mode every 0.25 seconds to ensure the precise maximum depth. In the logbook the data is saved in 1-second intervals.

As with Gauge mode, in Apnea mode the HUD doesn't carry out any decompression calculations. You can only switch to Apnea mode if the computer is completely desaturated.

 *NOTE: please keep in mind that the HUD starts displaying the depth at 0.8m/3ft.*

Also as with Gauge mode, when in Apnea mode, by rotating the push-wheel you can switch from the standard apnea screen to the profile display.

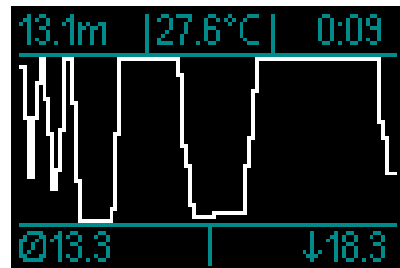

At the surface a counter starts to measure the time you stay on the surface.



After 15 minutes at the surface the session is finished and a log will be created. The next immersion will be stored in the next log.

During the dive the Navigation and Settings menus are always accessible.

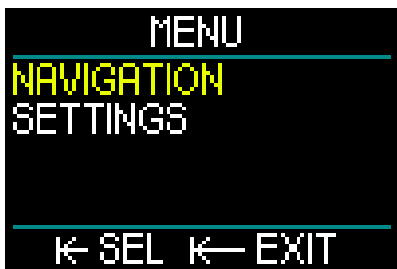

3.9 Navy mode

The Navy mode is designed specifically for combat swimmer operations. It is similar to Gauge mode in that it will only monitor depth, time, and temperature, and it will not carry out any decompression calculations. Navy mode differs from Gauge mode primarily in its mode of operation, its color settings and its screens.

To access the HUD's Navy mode, first press-and-release the push-wheel to turn the unit on. From the Surface screen, a press-and-release of the push-wheel takes you to the Main menu. Scroll down to Settings and press-and-release the push-wheel. From there select Dive – press-and-release, then Modes – press-and-release, which takes you to the screen below.

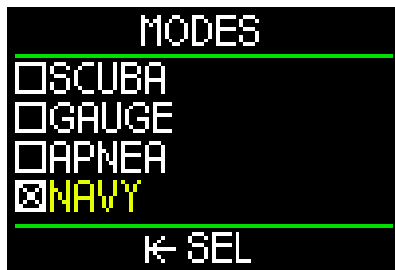

NOTE: When activating the Navy mode the lines on the screen will change colors based on the chosen Navy color (green, in the above case. You can find more information on Navy mode screen colors in chapter: 3.9.3.2 Display settings).

3.9.1 Operation – Switch screens

Once you've set your HUD to Navy mode, any time you turn on your HUD you will automatically enter the Navy dive screen, as seen below.

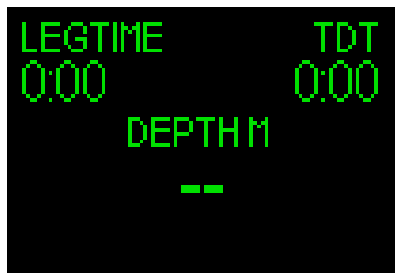

To cycle between the dive screen and other screens in Navy mode, press-and-hold the push-wheel. When you reach the screen you want to select, release the push-wheel.

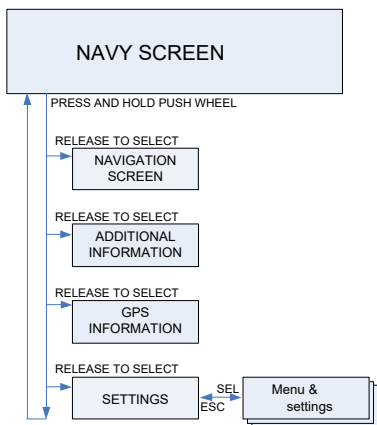

To select your Navy mode settings, repeat a press-and-hold of the push-wheel until the following Setting screen is displayed, then release the push-wheel.

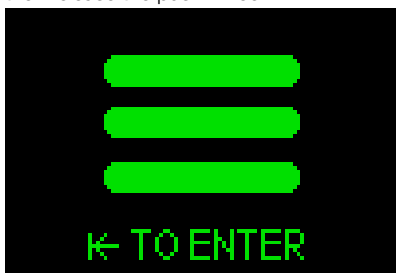

From here, a press-and-release of the push-wheel will take you into the Menu screen.

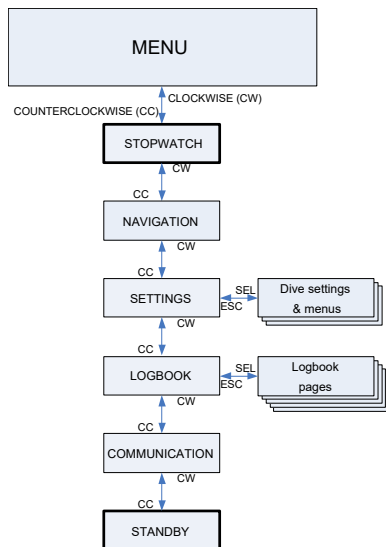

On the Menu screen, scroll down to Settings and press-and-release the push-wheel.

3.9.2 Settings

The Navy mode Settings menu offers the following categories, pages and settings:

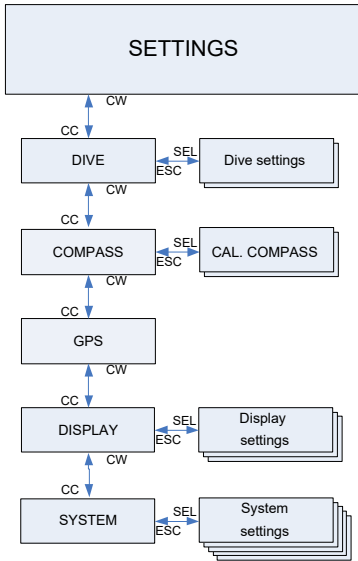

3.9.2.1 Dive settings

The Navy mode Dive settings menu offers the following categories, pages and settings:

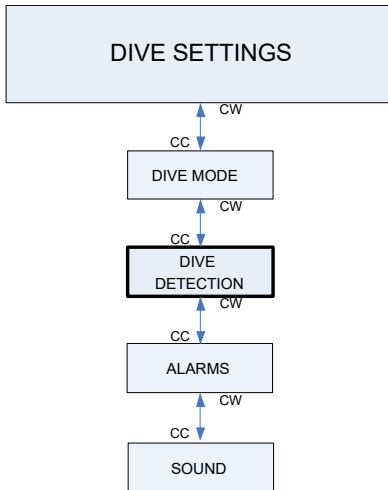

To change Dive mode, Alarms or Sound settings, see chapter 2.3.1 Dive settings.



The Dive Detection setting gives you the choice of automatic or manual activation.



When set to AUTO, your HUD will turn on automatically when its pressure sensor detects water pressure.

The MANUAL setting requires that you press-and-release the push-wheel to turn the unit on. This feature enables you to avoid any unexpected or unwanted light emission from the screen when entering the water.

NOTE: The MANUAL setting will not start the unit automatically.

To change Compass and GPS settings, see chapter: 2.3 Settings

3.9.2.2 Display settings

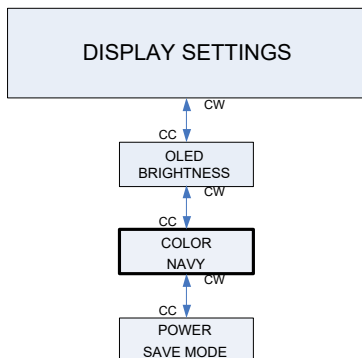

For more information on OLED brightness and the Power Save mode, see chapter: 2.3.6 Display.

The HUD's Navy mode provides a variety of colors to choose from: blue, green, red, white, yellow and pink.

You can immediately see how the color you select will look by looking at the lines on the display, like on the following screen.



By choosing the correct color and OLED brightness you are able to manage the light emitting from the HUD's screen.

3.9.3 Diving in Navy mode

In Navy mode there is no Surface screen, so after switching on the HUD the following Navy dive screen (bottom timer) appears and is automatically activated.



The Legtime, shown in the upper-left corner of the screen above, works like a stopwatch, displaying Min:Sec. With a press-and-release of the push-wheel you can start the Legtimer or reset it.

The TDT (total dive time) in the upper right corner starts to count when entering the water or after you have switched on the HUD while diving.

The depth in center-screen displays your current depth.

A press-and-hold of the push-wheel switches the display to the Navigation screen.

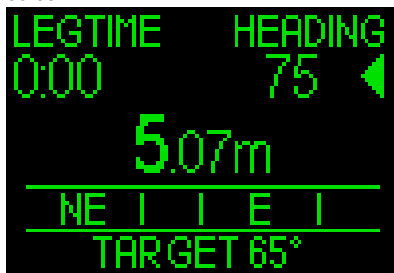

This screen provides compass direction and pre-adjusted bearings (or GPS waypoints when on the surface).

For example, the above screen shows a preset compass bearing (target) of 65°. Your current heading is 75°. So to maintain your bearing course you would need to turn to the right to come to the direction you have set.

By rotating the push-wheel you can switch between preset compass bearings and GPS waypoints.



When in GPS mode a lightning bolt icon will appear on the right side of the screen, just above the compass, indicating that the GPS connection is active.

The compass direction reads the same in GPS mode as in Compass mode.

The distance to your waypoint is shown after the waypoint name (in the above example – ZURICHSEE).

To set a waypoint see chapter: 5.2.4. Adding GPS waypoints.

By pressing-and-holding the push-wheel you will enter an additional screen providing local time, max depth, temperature and battery status.

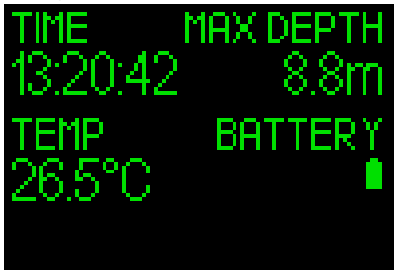

Another press-and-hold of the push-wheel takes you to the following GPS summary screen.



NOTE: the GPS works only at the surface.

NOTE: The Settings menu can be entered only when on the surface.

3.9.4 Operation – Switch off

To switch off your HUD while in Navy mode you can use the STANDBY function found on the Menu screen, or wait 5 minutes and it will shut off automatically.

4. HUD ACCESSORIES

4.1 Safety lanyard

The HUD's casing provides a small hole for attaching a lanyard. This enables you to create a backup attachment to your mask to prevent losing your HUD in the event of an unforeseen situation.



4.2 Additional mask mounts

On some masks the HUD's standard mount doesn't fit. For these masks there are optional mounts available. For more information, go to www.scubapro.com



4.3 Wireless high-pressure transmitter

The HUD supports wireless tank pressure using Smart series transmitters. Your HUD can monitor up to 8 transmitters.

Additional transmitters can be purchased separately from your authorized SCUBAPRO dealer.



 **NOTE:** There are 3 generations of Smart transmitters: Smart, Smart+ (longer distance) and Smart+ LED. The HUD is compatible with all of these versions.

4.4 Bluetooth USB stick

PCs with Bluetooth versions lower than 4.0 require a generic Bluetooth dongle 4.0 or higher in combination with a Windows operating system 8 or higher.

With older operating systems a BlueGiga type dongle is required.



 **NOTE:** Laptops with an old internal Bluetooth module (lower than 4.0) will require an external generic USB Bluetooth stick.

5. INTERFACES FOR THE HUD AND AN INTRODUCTION TO LOGTRAK

5.1 Establishing communication

The HUD provides a choice of 3 modes for connecting to a desktop, laptop or handheld device when you want to download dive data or upload firmware updates.

From the Main menu, rotate the push-wheel to toggle down to Communication, then press-and-release.

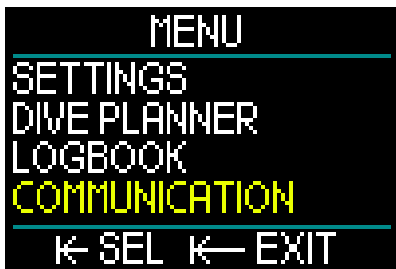

In the Communication menu screen you can choose from:

- DISK MODE
- LOG MODE
- BLUETOOTH MODE

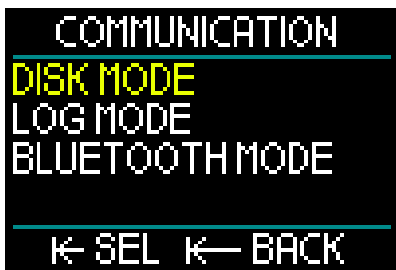

When selecting Disk mode, a press-and-release of the push-wheel will take you to the following screen:



Disk mode is a mode you would use with the USB connection.

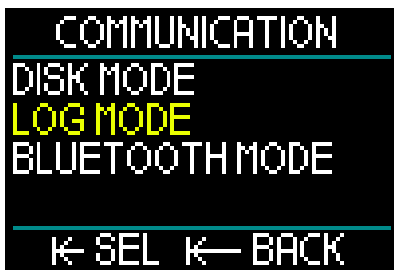

When Log mode is selected, a press-and-release of the push-wheel will take you to the following screen:

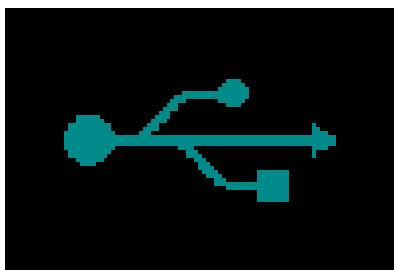

Log mode is another mode you would use with the USB connection.



When selecting Bluetooth mode, a press-and-release of the push-wheel will take you to the following screen:



At this point the HUD is ready for Bluetooth communication. Bluetooth is active only when this screen is displayed.

To achieve a Bluetooth connection, set the device you want your HUD to communicate with (e.g. an Apple or Android handheld device) to “scanning” mode.

The first time you do this will require inputting a safety code to ensure safe communication. The safety code is located on the screen below the Bluetooth symbol.

Once the code is accepted by the device you want to connect to, the link is then ready for communication, and the following display is shown on the HUD’s screen.



5.2 Interfacing with a PC/ Mac or handheld device

To connect the USB cable for interfacing with a personal computer, first plug the power/USB cable into your HUD as shown in the picture below.



Now plug the other end of the cable into a USB port in your personal computer, and you’re ready to start the interface process.

⚠ WARNING

Clean the contacts of your HUD before connecting.

⚠ WARNING

Always connect the HUD in a dry and clean environment.

5.2.1 Disk mode

Disk Mode allows you access to the HUD’s memory. In the following picture you can see the file structure of the HUD.

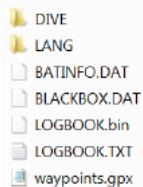

⚠ WARNING

Do not erase any of the system files from your HUD! Removing system folders will lead to a malfunctioning HUD. Diving with a HUD is not safe if data has been removed.

5.2.2 Updating your HUD

To perform a software update, first go to www.scubapro.com and click on the Resources tab. On the drop-down menu select Manuals & Software. From there scroll down the software list to find “HUDUpgrade.bin.”

Next, connect your HUD via USB to your personal computer and copy the file “HUDUpgrade.bin,” which is provided at www.scubapro.com, directly to your HUD.

Disconnect the HUD from your PC/MAC with the functionality of Safe Remove and Eject Media.

Shut off and then restart the HUD with a press-and-release of the push-wheel.

For about 30 seconds the display will remain black while the update is being performed in the background.

At this point the HUD will undergo a quick series of internal tests. After that, the start screen will appear, indicating that the software has been updated.

5.2.3 Updating languages

The HUD is delivered with the system language in English only. However, other languages are available at www.scubapro.com.

Add your preferred language to the folder LANG. After that, the added language is displayed in the language menu and can be activated.

5.2.4 Adding GPS waypoints

The HUD uses a GPX file. These can be generated by different route planners (freeware or licensed software). Partially, the software creates a KML file (e.g., Google maps). With the help of free conversion programs, these can also be converted into a GPX file.

Rename your GPX file to “waypoints.gpx” and replace it in your HUD.

Turn off and then restart the HUD. The new waypoints are now visible in the navigation menu under the Compass entries.

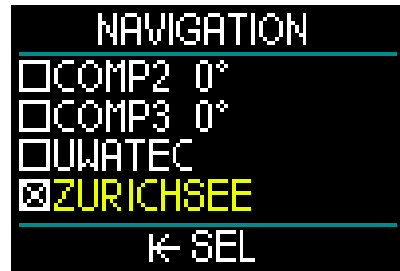

Sometimes the converters write extra information into the GPX file, which causes the HUD to no longer recognize it. If you have any problems, check with an editor tool to make sure that the name of the waypoint is written: <name>Zurichsee</name>

5.2.5 LOG and Bluetooth modes

LogTRAK is the software that allows the HUD to communicate with various operating systems. LogTRAK is available for Windows, Mac, Android and iOS. In the following section, Windows and Mac versions of LogTRAK are represented. Android and iPhone/iPad versions of LogTRAK operate similarly but do not have all of the features offered in the PC/Mac versions.

The communication to Logtrak on your PC/Mac can be established with Bluetooth or with the USB connection.

For a Bluetooth connection use the connection for Bluetooth low energy.

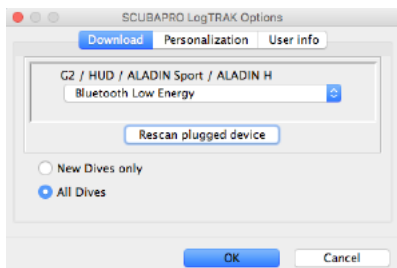

NOTE: the HUD has a timeout of 15 minutes for a non-active Bluetooth connection. After this interval the HUD will disable Bluetooth and shut down.

5.2.6 Connecting the HUD with LogTRAK

To start the communication using USB:

1. Connect to your HUD with the USB cable.
2. Use the Log Mode to establish the connection from the HUD.
3. Launch LogTRAK.
4. Check that the HUD is detected by LogTRAK.

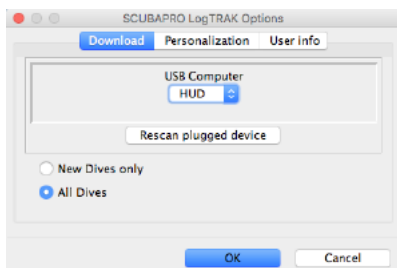

Extras -> Options -> download

If it is not automatically detected, run the "Rescan plugged device."

5.2.7 Download dive profiles

From LogTRAK, by selecting Dive -> Download Dives you can transfer the HUD Logbook to your PC/Mac.

There are 3 main views, each showing a specific part of your dive logs:

1. Profile, showing the graphical data of the dive.

2. Details about the dive, where you can edit, for example, the equipment and tank information.
3. Location, which shows your dive site on the world map.

The selection tabs for views are found along the left side of the main window.

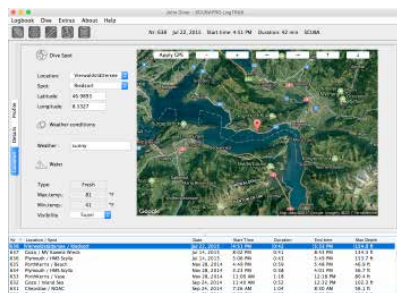
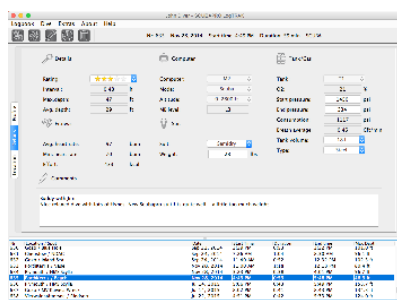
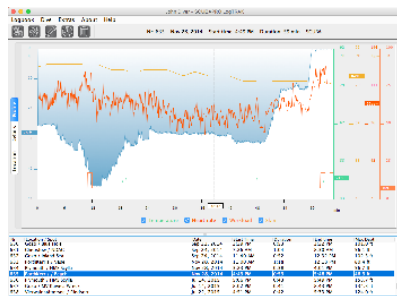

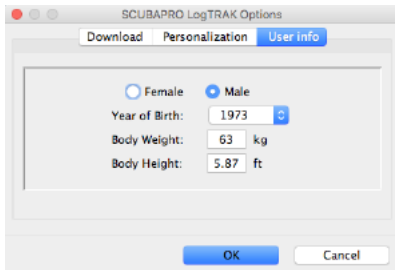

5.2.8 Reading computer information

By selecting Extras -> Read dive computer settings, you can find general computer information for your HUD.

By activating the box, using PC-Time and pressing "write" you can easily update your time and date.

Warnings and personal settings cannot be set with a PC, but are accessible with an Android device.

Setting units in LogTRAK:

You can set your units in your HUD or on your PC by using the following LogTRAK personalization section.

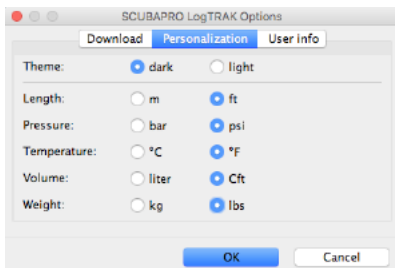

6. TAKING CARE OF YOUR HUD

6.1 Technical information

Operating altitude:

- Sea level to approximately 4000m/13300ft.

Max operating depth:

- 120m/394ft; resolution is 0.1m until 99.9m, and 1m at depths deeper than 100m. Resolution in feet is always 1ft. Accuracy is within 2% $\pm 0.2m/1ft$.

Decompression calculation:

- Range: 0.8m to 120m / 3ft to 394ft.

Clock:

- Quartz clock; time, date, dive time displays up to 99 minutes and 59 seconds, and in minute steps up to 999 minutes.

Oxygen concentration:

- Adjustable between 8% and 100%.

Helium concentration:

- Adjustable between 0% and 92%.

Operating temperature:

- -10C to +50C / 14F to 122F.

Power supply:

- Li-Ion battery, user chargeable via USB.

Operation time with fully charged battery:

- Up to 20h. Actual battery operation time depends primarily on the operational temperature and brightness settings, but also on many other factors.

6.2 Maintenance

The HUD's depth accuracy should be verified every 2 years by an authorized SCUBAPRO dealer.

The tank pressure gauge and the parts of this product used to measure tank pressure should be serviced by an authorized SCUBAPRO dealer every other year, or after 200 dives (whichever comes first).

Aside from that, the HUD is virtually maintenance-free. All you need to do is rinse it carefully with fresh water after each dive and charge the battery when needed. To avoid possible problems with your HUD,

the following recommendations will help assure years of trouble-free service:

1. Avoid dropping or jarring your HUD.
2. Do not expose your HUD to intense, direct sunlight.
3. Do not store your HUD in a sealed container; always ensure free ventilation.
4. If there are problems with the water or USB contacts, use soapy water to clean your HUD and dry it thoroughly. Do not use silicone grease on the water contacts!
5. Do not clean your HUD with liquids containing solvents.
6. Check the battery capacity before each dive.
7. If the battery warning appears, charge the battery.
8. If any error message appears on the display, take your HUD back to an authorized SCUBAPRO dealer.

6.3 Replacing the battery in transmitter



The following parts of the transmitter are shown in the drawing above:

- 1) Transmitter cap screws.
- 2) HP port O-ring.
- 3) Main O-ring.
- 4) CR 2/3 AA battery.
- 5) Transmitter cap.

To change the battery in the high-pressure transmitter:

1. Dry the transmitter with a soft towel.
2. Remove the screws.
3. Replace the main O-ring (replacement O-rings are available from your authorized SCUBAPRO dealer).
4. Remove the empty battery and recycle it in an environmentally friendly way.
5. Insert the new battery. Note the polarity, "+" is marked on the body. Do not touch poles or contacts with bare fingers.
6. Replace the screws.
7. Check the transmitter function and housing sealing.

WARNING

We recommend having the transmitter battery replaced by an authorized SCUBAPRO dealer. The change must be made with particular care in order to prevent water from seeping in. The warranty does not cover damages due to improper placement of the battery or the incorrect closing of the battery cap.

6.4 Warranty

The HUD has a 2-year warranty covering defects in workmanship and functioning. The warranty only covers dive computers which have been bought from an authorized SCUBAPRO dealer. Repairs or replacements during the warranty period do not extend beyond the warranty period itself.

Excluded from warranty coverage are faults or defects due to:

1. Excessive wear and tear.
2. Exterior influences, e.g. transport damage, damage due to bumping and hitting, influences of weather or other natural phenomena.
3. Servicing, repairs or the opening of the dive computer by anybody not authorized to do so by the manufacturer.
4. Pressure tests which do not take place in water.
5. Diving accidents.
6. Opening the HUD housing.
7. Commercial use

For European Union markets, the warranty of this product is governed by European legislation in force in each EU member state.

All warranty claims must be returned with dated proof-of-purchase to an authorized SCUBAPRO dealer. Visit www.scubapro.com for the dealer nearest you.



Your dive instrument is manufactured with high-quality components that can be recycled and reused. Nevertheless, these components, if not properly managed in accordance with the regulations on electrical and electronic equipment waste, are likely to cause harm to the environment and/or to human health. Customers living in the European Union can contribute to protecting the environment and health by returning old products to an appropriate collection point in their neighborhood in accordance with EU Directive 2012/19/UE. Collection points are provided by some distributors of the products and local authorities. Products marked with the recycling symbol on the left must not be disposed of in normal household waste.

7. GLOSSARY

AVG	Average Depth. Calculated from the beginning of the dive or from the time of reset.
CCR	Closed Circuit Rebreather. A breathing device that absorbs the carbon dioxide of a diver's exhaled breath to permit the recycling, or "rebreathing," of the unused oxygen content of each breath.
CNS O ₂	Central Nervous System Oxygen toxicity.
DESAT	Desaturation Time. The time needed for the body to completely eliminate any nitrogen taken up during diving.
Dive Time	The time spent below a depth of 0.8m/3ft.
Gas	Refers to the main gas that is set for the ZH-L16 ADT MB or ZH-L16 GF algorithms.
INT	Surface interval. The time that starts at the moment the dive is closed out.
Local Time	Current time in the local time zone.
Max Depth	Maximum depth attained during the dive.
MB	Microbubble. Microbubbles are tiny bubbles that can build up in a diver's body during and after a dive.
MB Level	One of 6 levels (L0-L5), provided by the HUD's ZH-L16 ADT algorithm.
MOD	Maximum Operating Depth. This is the depth at which the partial pressure of oxygen (ppO ₂) reaches the maximum allowed level (ppO ₂ max). Diving deeper than the MOD will expose the diver to unsafe ppO ₂ levels.
Nitrox	A breathing mix made of oxygen and nitrogen, with the oxygen concentration being 22% or higher. In this manual, air is considered a particular type of nitrox.
NO FLY	Minimum amount of time a diver should wait before taking a plane.
No-Stop Time	The amount of time a diver can stay at the current depth and still make a direct ascent to the surface without having to perform decompression stops.
O ₂	Oxygen.
O ₂ %	Oxygen concentration used by the HUD in all calculations.
PDIS	Profile Dependent Intermediate Stop is an additional deep stop which is suggested by the HUD at a depth where the 5th, 6th or 7th compartment starts off-gassing.
ppO ₂	Partial pressure of oxygen. This is the pressure of the oxygen in the breathing mix. It is a function of depth and oxygen concentration. A ppO ₂ higher than 1.6bar is considered dangerous.
ppO ₂ max	The maximum allowed value for ppO ₂ . Together with the oxygen concentration, it defines the MOD.
PMG	Predictive Multigas. Lets you carry additional breathing gases in addition to your main breathing gas.
Press/Release	The act of pressing-and-releasing the push-wheel.

Press/Hold	The act of pressing-and-holding the push-wheel for 1 second before releasing.
RBT	Remaining Bottom Time. The time you can spend at the current depth and still have enough gas supply to make a safe ascent and reach the surface with the tank reserve.
SOS Mode	The result of having completed a dive without respecting all mandatory decompression obligations.
Switch Depth	The depth at which the diver plans to switch to a different oxygen mix while using the multigas option.
TAT	Total Ascent Time.
Trimix	A gas mixture containing Oxygen, Helium and Nitrogen. Commonly used for technical diving and in some advanced recreational diving scenarios.
UTC	Universal Time Coordinated. This is the primary time standard used worldwide to regulate clocks and time. UTC correlates to your location's time zone through the use of offsets ranging from -12 to +14 hours.

8. INDEX

Warnings	38, 39, 56, 64
All-silent mode.....	39
Altimeter	6, 64
Ascent rate.....	37, 50, 57
Brightness	42
Battery	14, 15, 43, 50, 87
Time settings.....	20
CNS O ₂	57, 65
Date	18
Desaturation reset	44
Dive planner	46, 64
Diving at altitude	64
Flying after diving.....	64
Gauge mode	23, 33, 74
Logbook.....	6, 15, 49, 50, 75
Maintenance.....	86
MB levels.....	60
Microbubbles.....	60
MOD	29, 58
Nitrox	29, 51, 65, 69, 70
No-fly time.....	6, 23, 50, 52
Oxygen concentration	62, 65, 67, 86
Oxygen partial pressure	65
PC interface.....	83
ppO ₂ max.....	37, 65
Safety stop timer	37, 57
LogTRAK.....	82, 84, 86
SOS mode	23
Surface interval.....	49, 50
Technical information	86
Time of day	20
Units.....	21, 44, 86
UTC.....	18

